

## DATASHEET

### Single-Channel Superluminescent Diode Source

#### Integrated Spectral Bench (ISB1)

**Single-SLED Light Source, 1 SLED: 1340nm, PM Fiber,  
High Degree of Polarization, Spectral Coverage: 1310nm – 1370nm,  
FWHM: 60nm, CW: 1340nm, Light Output Power >12mW**

**Luxmux Part Number: ASM002502**



## A. PRODUCT DESCRIPTION

The Single-SLED Integrated Spectral Bench (ISB1) product is a compact Superluminescent Diode (SLED) solution that employs Luxmux’s high-performance Optical Spectral Engine (OSE) module. The ISB1 is a broadband light source that operates in the near infrared range. It is a turn-key product that can easily be integrated into existing devices that require light power.

The Single-SLED ISB1 includes an integrated isolator and a proprietary driver and controller, each of which enable the light power to easily be adjusted. A Graphical User Interface (GUI) with a USB, RS232 or Ethernet connection allows for external monitoring and adjustment capabilities. The Single-SLED ISB1’s light output is powered by a standard FC/APC connector (FC/PC or SMA available upon request).

## B. KEY FEATURES

- User-controlled box with one SLED enclosed
- Compact and user-friendly
- Centre wavelength (CW): 1340nm
- SLED can be run from 0% to 100% of maximum rating
- Output power: 12mW
- Bandwidth FWHM: 60nm
- Internally optimized for maximum coupling efficiency with PM1300-XP Fiber
- Monolithic integration of a broadband dual stage PMF isolator (35dB)
- Includes a monitor photodiode
- Light output connector: FC/APC (optional: FC/PC or SMA)
- Multiple communication interfaces: USB, RS-232, Ethernet
- User-friendly GUI and custom API available for test automation
- Optional power meter available

## C. APPLICATIONS

- Optical Component Testing
- Telecom Test Equipment
- Medical Optical Coherence Tomography
- Industrial Optical Coherence Tomography
- Fiber Optic Gyroscopes
- Metrology
- Biomedical Imaging Systems
- Optical Sensing
- White Light Interferometry
- Research and Development

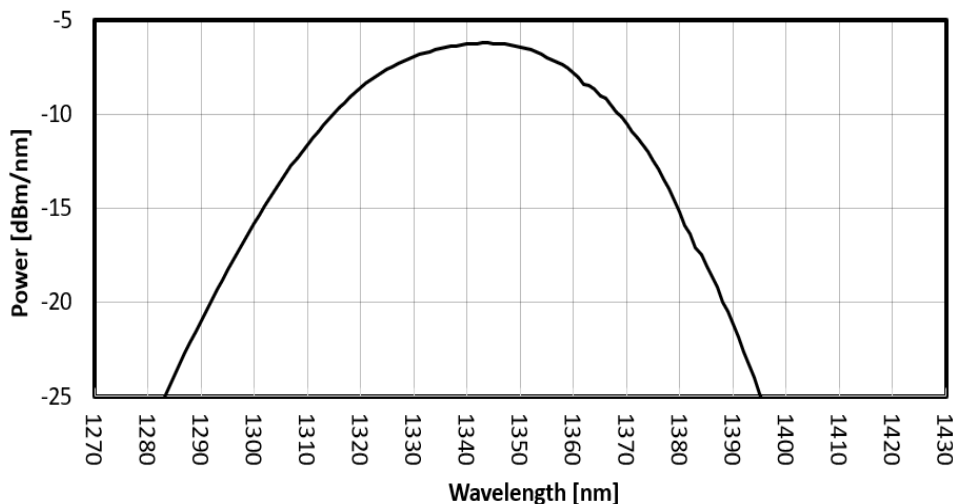



## Redefining Spectral Boundaries

### D. ABSOLUTE MAXIMUM RATINGS

| Parameter                                  | Symbol            | Condition                 | Minimum | Maximum | Unit |
|--|-------------------|---------------------------|---------|---------|------|
| <b>DRIVER POWER SUPPLY SPECIFICATIONS</b>  |                   |                           |         |         |      |
| Input Power Supply Voltage                 | V <sub>s</sub>    | CW                        | 10      | 14      | V    |
| Input Power Supply Current                 | I <sub>s</sub>    | CW                        | 5       | -       | A    |
| <b>TEMPERATURE SPECIFICATIONS</b>          |                   |                           |         |         |      |
| Case Temperature (see note 2)              | T <sub>Case</sub> |                           | 0       | 60      | °C   |
| Storage Temperature (see note 4)           | T <sub>stg</sub>  | No condensation, Unbiased | -40     | 85      | °C   |
| Storage Humidity (see note 4)              | RH <sub>stg</sub> |                           | 5       | 85      | %RH  |
| Ambient Operating Temperature (See note 3) | T <sub>OP</sub>   |                           | 0       | 50      | °C   |

**Notes:**

- Please note that exceeding the Absolute Maximum Ratings above may cause device failure. Luxmux does not bear responsibility for laser power damage that is attributed to electrostatic discharge, excessive current levels, and current spikes (transients). Any attempts to increase the laser drive current above the pre-set limits or recommended specification limits, can damage the device, and nullify the warranty period. It should be emphasized that the current limit set points cannot be exceeded.
- For optimum performance of the Integrated Spectral Bench (ISB1), the ISB1 must be operated within the specified temperature ranges. The Single-SLED<sup>®</sup> has an internal thermoelectric cooler (TEC) to remove heat from the light source and dissipate it through the ISB1 case. It is required to provide free air circulation around the ISB1 device. It is always recommended to cool down the unit with a fan, and/or to mount the ISB1 on an appropriate heatsink, capable of dissipating up to 10W. The thermal resistance between ISB1 metal case and heatsink can be minimized by applying thermal grease, thermal glue or thermal pad between the contact surfaces. **When the Single-SLED<sup>®</sup> is used without a heatsink, maximum ambient operating temperature is 40°C.** The specification lists the operating temperature for the electrical/optical characteristics, which is the temperature of the ISB1 during the time that the specifications were measured. Variation in temperature beyond what is specified can have a significant effect on the optical characteristics, like changes in wavelength or drop in output power.
- Storage temperature and relative humidity should be chosen so the dew point of the humid air around the package is below the storage temperature of the package, to avoid condensation inside the ISB1 enclosure.



## Redefining Spectral Boundaries

### E. OPTICAL AND ELECTRICAL SPECIFICATIONS (see note 5)

| Parameter                                   | Symbol          | Condition   | Minimum | Typical     | Maximum | Unit  |
|---|-----------------|---|---------|-------------|---------|-------|
| <b>DRIVER POWER SUPPLY SPECIFICATIONS</b>   |                 |   |         |             |         |       |
| Input Power Supply Voltage                  | $V_S$           | CW  | 10      | 12          | 14      | V     |
| Input Power Supply Current                  | $I_S$           | CW  | 5       | -           | -       | A     |
| Input Power Supply Voltage Ripple and Noise | $\gamma$        | CW  | -       | -           | 200     | mVpp  |
| <b>OPTICAL SPECIFICATIONS</b>               |                 |   |         |             |         |       |
| Center Wavelength (see note 6)              | CWL             | CW<br>$T_{OP} = 25^\circ\text{C}$<br>$T_{TEC} = 21^\circ\text{C}$             | 1330    | 1340        | 1350    | nm    |
| PM Fiber Coupled Power (see note 7)         | P               | CW<br>$T_{OP} = 25^\circ\text{C}$<br>$T_{TEC} = 21^\circ\text{C}$ $I_{OP}$    | 12      | -           | -       | mW    |
| Bandwidth FWHM (see note 8)                 | $B_{FWHM}$      | CW<br>$T_{OP} = 25^\circ\text{C}$<br>$T_{TEC} = 21^\circ\text{C}$ $I_{OP}$    | 60      | 65          | -       | nm    |
| Bandwidth @ -10dB (see note 5)              | $B_{@10dB}$     | CW<br>$T_{OP} = 25^\circ\text{C}$<br>$T_{TEC} = 21^\circ\text{C}$ $I_{OP}$    | -       | 80          | -       | nm    |
| Spectrum Ripple (see note 9)                | R               | CW<br>$T_{OP} = 25^\circ\text{C}$<br>$T_{TEC} = 21^\circ\text{C}$             | < 0.15  | < 0.30      | < 0.45  | dB    |
| Spectral Coverage                           | SC              | CW<br>$T_{OSE2} = 25^\circ\text{C}$<br>$T_{TEC} = 21^\circ\text{C}$ $I_{OP}$  | -       | 1310 – 1370 | -       | nm    |
| Polarization Extinction Ratio (see note 10) | PER             | CW<br>$T_{OP} = 25^\circ\text{C}$<br>$T_{TEC} = 21^\circ\text{C}$<br>$I_{OP}$ | 10      | -           | -       | dB    |
| RIN   | RIN             |   | -       | < -130      | -       | dB/Hz |
| Power Stability (After 1h warm up)          | $P_{STAB}$      | @ $25^\circ\text{C} \pm 1^\circ\text{C}$                                      | -       | < 0.1       | -       | dB    |
| Warmup Time                                 | W               |   | 15      | 30          | 60      | Min.  |
| <b>CONSTANT CURRENT MODE</b>                |                 |   |         |             |         |       |
| Operating Current                           | $I_{OP}$        | CW<br>$T_{OP} = 25^\circ\text{C}$<br>$T_{TEC} = 21^\circ\text{C}$             | -       | -           | 350     | mA    |
| Current Setting Resolution                  | $R_{IOP\_SET}$  |   | -       | -           | 0.1     | mA    |
| SLED Current Reading Resolution             | $R_{IOP\_READ}$ |   | -       | 0.1         | -       | mA    |

#LTC-ISB1-1340-PM-HP-1310\_1370-60-1340-12\_DS\_2021\_08\_05

This document is the property of Luxmux, and contains proprietary information. Luxmux reserves the right to make product design or specification changes without notice.



## Redefining Spectral Boundaries

| Parameter                                | Symbol            | Condition             | Minimum            | Typical                  | Maximum             | Unit             |
|--|-------------------|-----------------------|--------------------|--------------------------|---------------------|------------------|
| <b>MODULATION MODE</b>                   |                   |                       |                    |                          |                     |                  |
| Waveform                                 |                   |                       | -                  | Square                   | -                   |                  |
| Modulation Frequency Range               | $f_{mod}$         |                       | 0.016              | -                        | 1000                | Hz               |
| Duty Cycle                               | D                 |                       | 10                 | 50                       | 90                  | %                |
| <b>INTERNAL MONITOR DIODE</b>            |                   |                       |                    |                          |                     |                  |
| Monitor Diode Current Reading            | $I_{mon}$         |                       | -                  | -                        | 500                 | $\mu$ A          |
| Monitor Diode Current Reading Resolution | $RES_{I_{mon}}$   |                       | -                  | 7.6                      | -                   | nA               |
| <b>LIGHT OUTPUT CONNECTOR</b>            |                   |                       |                    |                          |                     |                  |
| Type of Fiber Connector                  |                   |                       | -                  | FC/PC,<br>FC/APC,<br>SMA | -                   |                  |
| <b>SLED TEC SPECIFICATIONS</b>           |                   |                       |                    |                          |                     |                  |
| SLED TEC Temperature Setpoint            | $T_{SLED\_SET}$   |                       | 0                  | -                        | 40                  | $^{\circ}$ C     |
| SLED TEC Temperature Setpoint Resolution | $R_{TSLED\_SET}$  |                       | -                  | 0.1                      | -                   | $^{\circ}$ C     |
| SLED TEC Temperature Reading             | $T_{SLED\_READ}$  |                       | -40                | -                        | 100                 | $^{\circ}$ C     |
| SLED TEC Temperature Reading Resolution  | $R_{TSLED\_READ}$ |                       | -                  | 0.1                      | -                   | $^{\circ}$ C     |
| <b>TEMPERATURE SPECIFICATIONS</b>        |                   |                       |                    |                          |                     |                  |
| Heatsink Temperature Reading Range       | $T_{HS}$          |                       | -40                | -                        | 100                 | $^{\circ}$ C     |
| Heatsink Temperature Reading Resolution  | $R_{THS}$         |                       | -                  | 0.1                      | -                   | $^{\circ}$ C     |
| <b>POWER METER</b>                       |                   |                       |                    |                          |                     |                  |
| Spectral Response Range                  | $\lambda_{PM}$    |                       | 900                | -                        | 1870                | nm               |
| Photosensitive Area                      | $A_{PM}$          |                       | -                  | $\Phi 1$                 | -                   | mm               |
| Power Meter Current Reading              | $P_{PM}$          |                       | 50                 | -                        | -                   | $\mu$ A          |
| Peak Sensitivity Wavelength              | $\lambda_p$       |                       | -                  | 1750                     | -                   | nm               |
| Photo Sensitivity                        | S                 | $\lambda = \lambda_p$ | 0.9                | 1.1                      | -                   | A/W              |
| Typical Dark Current                     | $I_D$             |                       | -                  | 1                        | 10                  | nA               |
| Detectivity                              | $D^*$             | $\lambda = \lambda_p$ | $2 \times 10^{12}$ | $5.5 \times 10^{12}$     |                     | $cm^*Hz^{1/2}/W$ |
| Noise Equivalent Power                   | NEP               | $\lambda = \lambda_p$ | -                  | $1.5 \times 10^{-14}$    | $4 \times 10^{-14}$ | $W/Hz^{1/2}$     |

#LTC-ISB1-1340-PM-HP-1310\_1370-60-1340-12\_DS\_2021\_08\_05

This document is the property of Luxmux, and contains proprietary information. Luxmux reserves the right to make product design or specification changes without notice.



## Redefining Spectral Boundaries

| Parameter                                       | Symbol                | Condition | Minimum | Typical | Maximum | Unit |
|---|-----------------------|-----------|---------|---------|---------|------|
| <b>POWER METER TEC SPECIFICATIONS</b>           |                       |           |         |         |         |      |
| Power Meter TEC Temperature Setpoint            | T <sub>PM_SET</sub>   |           | -20     | -       | 40      | °C   |
| Power Meter TEC Temperature Setpoint Resolution | R <sub>TPM_SET</sub>  |           | -       | 0.1     | -       | °C   |
| Power Meter TEC Temperature Reading             | T <sub>PM_READ</sub>  |           | -40     | -       | 85      | °C   |
| Power Meter TEC Temperature Reading Resolution  | R <sub>TPM_READ</sub> |           | -       | 0.1     | -       | °C   |

**Notes:**

5. *There may be differences in typical values of output power, power stability, wavelength and bandwidth, due to coupling efficiency. These values are references and there is no guarantee that each particular ISB1 module will have EXACTLY the typical values shown on the previous chart.*
6. *Center Wavelength is defined as the center point of the 3dB bandwidth of the SLED.*
7. *The ISB1 uses a Dual Stage Isolator for back reflection protection. Isolators are used to protect a source from back reflections or signals that may occur after the isolator. Back reflections can damage a laser source or cause it to amplitude modulate, or frequency shift. In high-power applications, back reflections can cause instabilities and power spikes. Luxmux does not bear responsibility for laser power damage that is attributed to hot spots in the beam.*
8. *Single-SLED® FWHM is defined as the bandwidth from the lowest spectral dip, when the SLED is on.*
9. *Resolution of 0.1nm.*
10. *Polarization Extinction Ratio is defined as the ratio of optical powers of perpendicular polarizations, expressed in decibels (dB).*

## F. PLOTS – Test performed at $T_{OP}=25^{\circ}C$ and $T_{TEC}=21^{\circ}C$

**FIG. 1: ISB1 SPECTRUM**

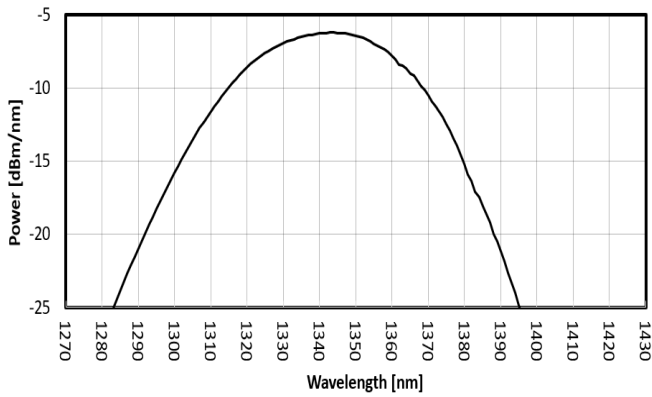

**FIG. 2: SLED OUTPUT POWER VS CURRENT**

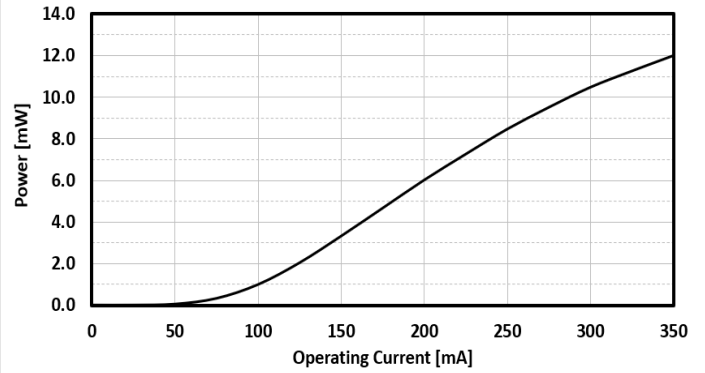

**FIG. 3: ISB1 TYPICAL POWER STABILITY**

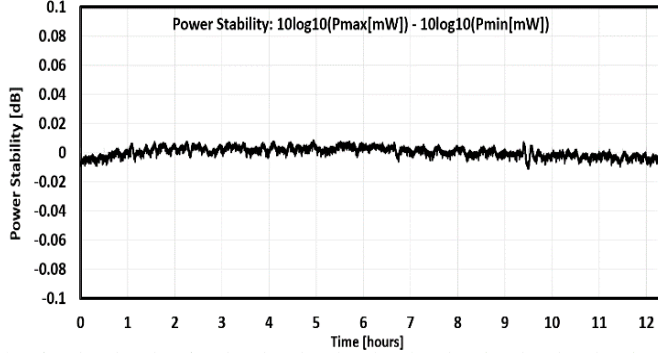

**FIG. 4: WARM-UP TIME**

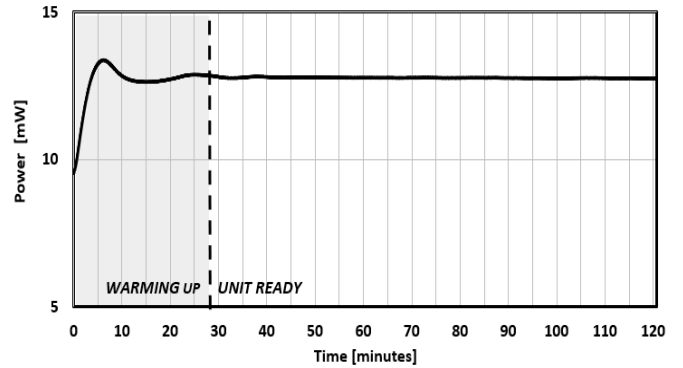

## G. CONNECTORS

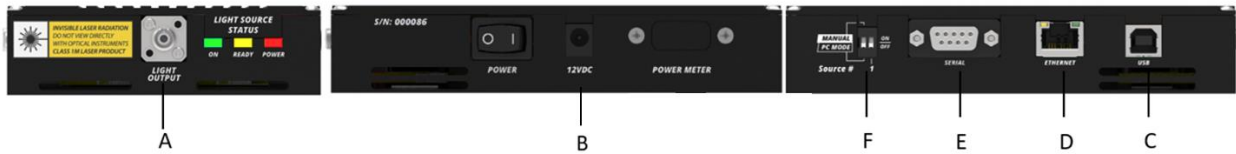

| Item | Description  |
|------|--|
| A    | FC/APC Connector (Optional: FC/PC, SMA)  |
| B    | Power Barrel Connector Jack 2.00mm ID, 5.50mm OD, 9.5 mm Length. Center Positive $\ominus - \oplus$<br>Input: AC 100-240V Output: 12V 5V min |
| C    | USB 2.0 Type B   |
| D    | RJ45 for MODBUS TCP/IP Communication   |
| E    | D-SUB 9 Positions for RS-232 Communication   |
| F    | Switches to change between PC Mode - Manual Mode and to turn SLED on when operating in Manual Mode   |

**H. D-SUB CONNECTOR PIN OUT**

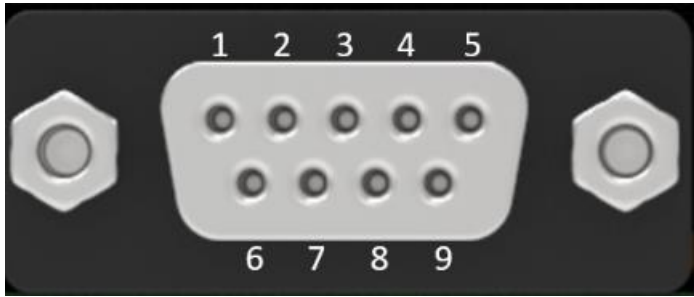

| Pin # | Function RS-232 |
|-------|-----------------|
| 1     | Not used        |
| 2     | Tx              |
| 3     | Rx              |
| 4     | Not used        |
| 5     | GND             |
| 6     | Not used        |
| 7     | Not used        |
| 8     | Not used        |
| 9     | Not used        |

**I. MANUAL CONTROL**

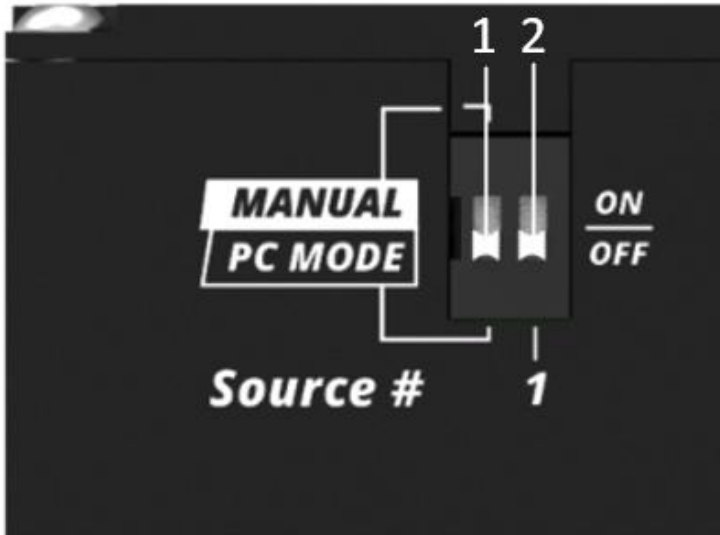

| Pin # | UP                          | DOWN                    |
|-------|-----------------------------|-------------------------|
| 1     | Light Source in Manual Mode | Light Source in PC Mode |
| 2     | SLED ON                     | SLED OFF                |



**J. OSE1 14-PIN BUTTERFLY PACKAGE PIN OUT**

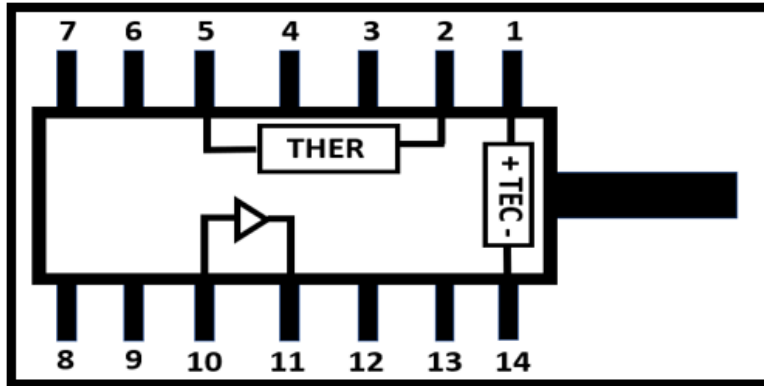

| EXTERNAL PIN ASSIGNMENT |            |    |                  |
|-------------------------|------------|----|------------------|
| 1                       | TEC (+)    | 8  | NC               |
| 2                       | Thermistor | 9  | NC               |
| 3                       | NC         | 10 | SLED Anode (+)   |
| 4                       | NC         | 11 | SLED Cathode (-) |
| 5                       | Thermistor | 12 | NC               |
| 6                       | NC         | 13 | Case             |
| 7                       | NC         | 14 | TEC (-)          |

## K. MECHANICAL DIAGRAM – STANDARD ISB1

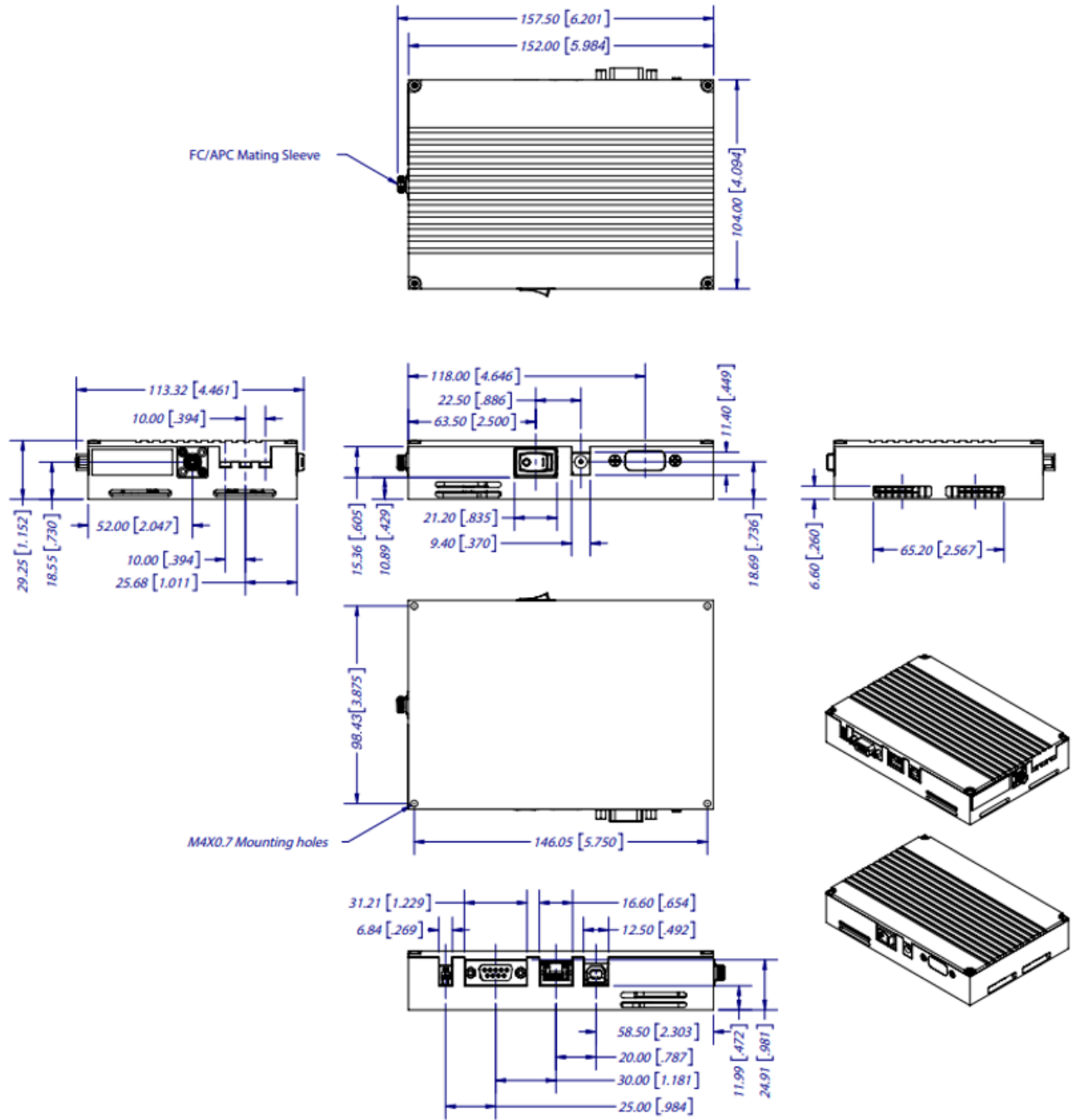

## L. MECHANICAL DIAGRAM – STANDARD ISB1 WITH POWER METER

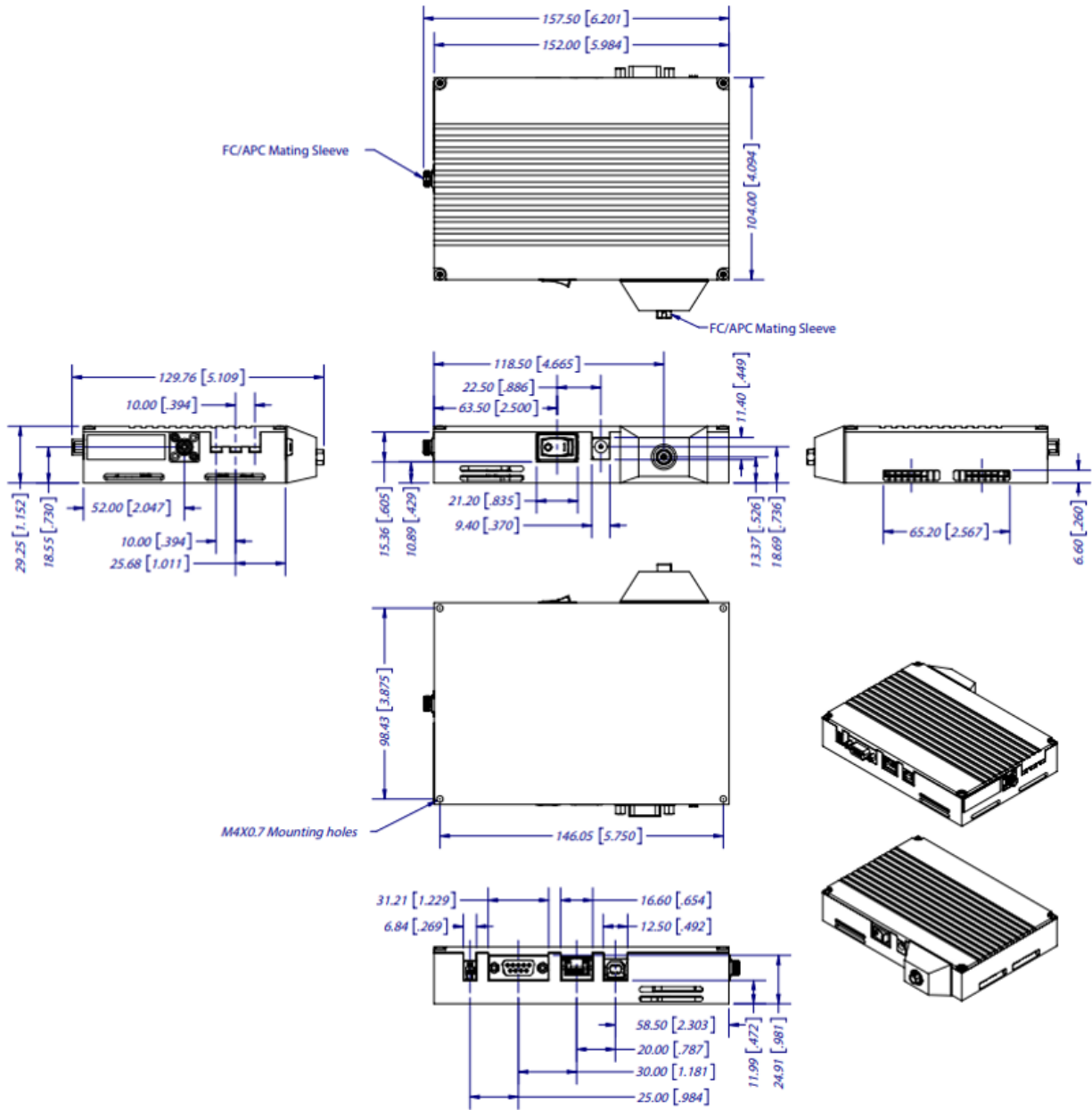

### **M. SAFETY**

All statements regarding safety of operation and technical data will only apply when the unit is operated correctly.

The driver must not be operated in environments susceptible to explosion hazards. Do not obstruct the air ventilation slots. If any parts of the driver, or electronics are broken or exposed, contact Luxmux technical support and do not attempt to operate the unit.

The ISB1 is a Class 1M laser product. It is safe for all conditions of use except when passed through magnifying optics such as microscopes and telescopes. It produces a beam that is divergent. If light is re-focused use protective eye wear.

### **N. APPLICATION PROTOCOL INTERFACE (API)**

Luxmux's driver utilizes the MODBUS Protocol for communications. Users can find numerous detailed specifications for the protocol on the internet. MODBUS is used widely in industrial applications. The driver is designed to use this protocol over all of its communication interfaces, MODBUS – RTU is a master/slave protocol and is employed by the USB or RS232 port, and MODBUS - TCP/IP is a client/server protocol and is employed by the Ethernet Interface.

The MODBUS specification has outlined how a user can adapt the overall packet structure to suit each interface requirement. The primary section of a MODBUS packet is known as the Protocol Data Unit (PDU) and it is independent of the underlying communication interface. The PDU includes additional byte fields for the MODBUS transaction per the Application Data Unit (ADU).

A high-level overview of MODBUS Protocol can be found on the ISB1 User Manual. If users want to develop their own API, the ISB1 Register Map is available upon request. Please contact technical support: [techsupport@luxmux.com](mailto:techsupport@luxmux.com).



# Redefining Spectral Boundaries

## O. ORDERING CODE

| ORDERING CODE: |   | LTC | ISB1 | SLEDs | FT | DOP | SC | FWHM | CW | LOP |
|----------------|---|-----|------|-------|----|-----|----|------|----|-----|
| LTC            | Luxmux Technology Corporation   |     |      |       |    |     |    |      |    |     |
| ISB1           | Single-sled® Integrated Spectral Bench G1   |     |      |       |    |     |    |      |    |     |
| SLEDs          | SLED center wavelength, choose one of the following models:<br>1300nm, 1340nm, 1390nm, 1430nm, 1480nm, 1550nm, 1615nm, 1680nm |     |      |       |    |     |    |      |    |     |
| FT             | Fiber Type, choose 1:<br>PM: Polarization Maintaining<br>SM: Single Mode  |     |      |       |    |     |    |      |    |     |
| DOP            | Degree of Polarization<br>LP: Low Degree of Polarization<br>HP: High Degree of Polarization                                   |     |      |       |    |     |    |      |    |     |
| SC             | Spectral Coverage [nm]  |     |      |       |    |     |    |      |    |     |
| FWHM           | Full Width Half Maximum [nm]<br>[FWHM defined as the bandwidth from the lowest spectral dip]                                  |     |      |       |    |     |    |      |    |     |
| CW             | Center Wavelength [nm]  |     |      |       |    |     |    |      |    |     |
| LOP            | Light Output Power [mW]   |     |      |       |    |     |    |      |    |     |

Product Code  
 Available Options  
 Taken From Table

| Part Number | Ordering Code: LTC-ISB1-(SLED)-(FT)-(DOP)-(SC)-(FWHM)-(CW)-(LOP) | SLED [nm] | FT | SC [nm]   | FWHM [nm] | CW [nm] | LOP [mW] |
|-------------|--|-----------|----|-----------|-----------|---------|----------|
| ASM002501   | LTC-ISB1-1300-PM-HP-1270_1330-60-1300-12                         | 1300      | PM | 1270-1330 | 60        | 1300    | 12       |
| ASM002502   | LTC-ISB1-1340-PM-HP-1310_1370-60-1340-12                         | 1340      | PM | 1310-1370 | 60        | 1340    | 12       |
| ASM002503   | LTC-ISB1-1390-PM-HP-1360_1420-60-1390-10                         | 1390      | PM | 1360-1420 | 60        | 1390    | 10       |
| ASM002504   | LTC-ISB1-1430-PM-HP-1410_1450-40-1430-10                         | 1430      | PM | 1410-1450 | 40        | 1430    | 10       |
| ASM002505   | LTC-ISB1-1480-PM-HP-1455_1505-50-1480-13                         | 1480      | PM | 1455-1505 | 50        | 1480    | 13       |
| ASM002506   | LTC-ISB1-1550-PM-HP-1515_1585-70-1550-15                         | 1550      | PM | 1515-1585 | 70        | 1550    | 15       |
| ASM002507   | LTC-ISB1-1615-PM-HP-1585_1645-60-1615-6                          | 1615      | PM | 1585-1645 | 60        | 1615    | 6        |
| ASM002508   | LTC-ISB1-1680-PM-HP-1655_1705-50-1680-13                         | 1680      | PM | 1655-1705 | 50        | 1680    | 8        |
| ASM002509   | LTC-ISB1-1550-PM-HP-1500_1600-70-1550-8                          | 1550      | PM | 1500-1600 | 70        | 1550    | 8        |
| ASM002512   | LTC-ISB1-1550-PM-HP-1532_1568-35-1550-30                         | 1550      | PM | 1532-1568 | 35        | 1550    | 30       |

| Part Number | Ordering Code: LTC-ISB1-(SLED)-(FT)-(DOP)-(SC)-(FWHM)-(CW)-(LOP) | SLED [nm] | FT | SC [nm]   | FWHM [nm] | CW [nm] | LOP [mW] |
|-------------|--|-----------|----|-----------|-----------|---------|----------|
| ASM002601   | LTC-ISB1-1300-SM-HP-1270_1330-60-1300-12                         | 1300      | SM | 1270-1330 | 60        | 1300    | 12       |
| ASM002602   | LTC-ISB1-1340-SM-HP-1310_1370-60-1340-12                         | 1340      | SM | 1310-1370 | 60        | 1340    | 12       |
| ASM002603   | LTC-ISB1-1390-SM-HP-1360_1420-60-1390-10                         | 1390      | SM | 1360-1420 | 60        | 1390    | 10       |
| ASM002604   | LTC-ISB1-1430-SM-HP-1410_1450-40-1430-10                         | 1430      | SM | 1410-1450 | 40        | 1430    | 10       |
| ASM002605   | LTC-ISB1-1480-SM-HP-1455_1505-50-1480-13                         | 1480      | SM | 1455-1505 | 50        | 1480    | 13       |
| ASM002606   | LTC-ISB1-1550-SM-HP-1515_1585-70-1550-15                         | 1550      | SM | 1515-1585 | 70        | 1550    | 15       |
| ASM002607   | LTC-ISB1-1615-SM-HP-1585_1645-60-1615-6                          | 1615      | SM | 1585-1645 | 60        | 1615    | 6        |
| ASM002608   | LTC-ISB1-1680-SM-HP-1655_1705-50-1680-13                         | 1680      | SM | 1655-1705 | 50        | 1680    | 8        |
| ASM002609   | LTC-ISB1-1550-SM-HP-1500_1600-70-1550-8                          | 1550      | SM | 1500-1600 | 70        | 1550    | 8        |
| ASM002612   | LTC-ISB1-1550-SM-HP-1532_1568-35-1550-30                         | 1550      | SM | 1532-1568 | 35        | 1550    | 30       |

#LTC-ISB1-1340-PM-HP-1310\_1370-60-1340-12\_DS\_2021\_08\_05

This document is the property of Luxmux, and contains proprietary information. Luxmux reserves the right to make product design or specification changes without notice.



## Redefining Spectral Boundaries

| Part Number | Ordering Code: LTC-ISB1-(SLED)-(FT)-(DOP)-(SC)-(FWHM)-(CW)-(LOP) | SLED [nm] | FT | SC [nm]   | FWHM [nm] | CW [nm] | LOP [mW] |
|-------------|--|-----------|----|-----------|-----------|---------|----------|
| ASM002701   | LTC-ISB1-1300-SM-LP-1270_1330-60-1300-12                         | 1300      | SM | 1270-1330 | 60        | 1300    | 12       |
| ASM002702   | LTC-ISB1-1340-SM-LP-1310_1370-60-1340-12                         | 1340      | SM | 1310-1370 | 60        | 1340    | 12       |
| ASM002703   | LTC-ISB1-1390-SM-LP-1360_1420-60-1390-10                         | 1390      | SM | 1360-1420 | 60        | 1390    | 10       |
| ASM002704   | LTC-ISB1-1430-SM-LP-1410_1450-40-1430-10                         | 1430      | SM | 1410-1450 | 40        | 1430    | 10       |
| ASM002705   | LTC-ISB1-1480-SM-LP-1455_1505-50-1480-13                         | 1480      | SM | 1455-1505 | 50        | 1480    | 13       |
| ASM002706   | LTC-ISB1-1550-SM-LP-1515_1585-70-1550-15                         | 1550      | SM | 1515-1585 | 70        | 1550    | 15       |
| ASM002707   | LTC-ISB1-1615-SM-LP-1585_1645-60-1615-6                          | 1615      | SM | 1585-1645 | 60        | 1615    | 6        |
| ASM002708   | LTC-ISB1-1680-SM-LP-1655_1705-50-1680-13                         | 1680      | SM | 1655-1705 | 50        | 1680    | 8        |
| ASM002709   | LTC-ISB1-1550-SM-LP-1500_1600-70-1550-8                          | 1550      | SM | 1500-1600 | 70        | 1550    | 8        |
| ASM002712   | LTC-ISB1-1550-SM-LP-1532_1568-35-1550-30                         | 1550      | SM | 1532-1568 | 35        | 1550    | 30       |

#LTC-ISB1-1340-PM-HP-1310\_1370-60-1340-12\_DS\_2021\_08\_05

This document is the property of Luxmux, and contains proprietary information. Luxmux reserves the right to make product design or specification changes without notice.

Luxmux Technology Corporation, 1030-2424 4<sup>th</sup> Street SW, Calgary, Canada, T2S 2T4  
[sales@luxmux.com](mailto:sales@luxmux.com), +1 (587) 392-6192, [www.luxmux.com](http://www.luxmux.com)