



American Opto Plus LED Corp.
0.39" SMD Type LED Display
SMA391W G/W
SMC391W G/W

● **FEATURES**

- 0.39 inch (10.0 mm) Digit Height.
- SMD type.
- Low current operation.
- Gray face, White segment.
- RoHS compliant, Pb Free.

● **DESCRIPTION**

The SMA391W G/W & SMC391W G/W are 0.39 inch (10.0mm) height
Single 7-segment displays.

This device utilizes Super Bright White LED chip which are made from InGaN
On a transparent GaN, substrate.

The display has Gray face, White segment.

● **DEVICE**

PART NO	DESCRIPTION
SMA391W G/W	Common Anode
SMC391W G/W	Common Cathode

RoHS Compliance



Pb free.





American Opto Plus LED Corp.

0.39" SMD Type LED Display

SMA391W G/W

SMC391W G/W

MECHANICAL DIMENSIONS

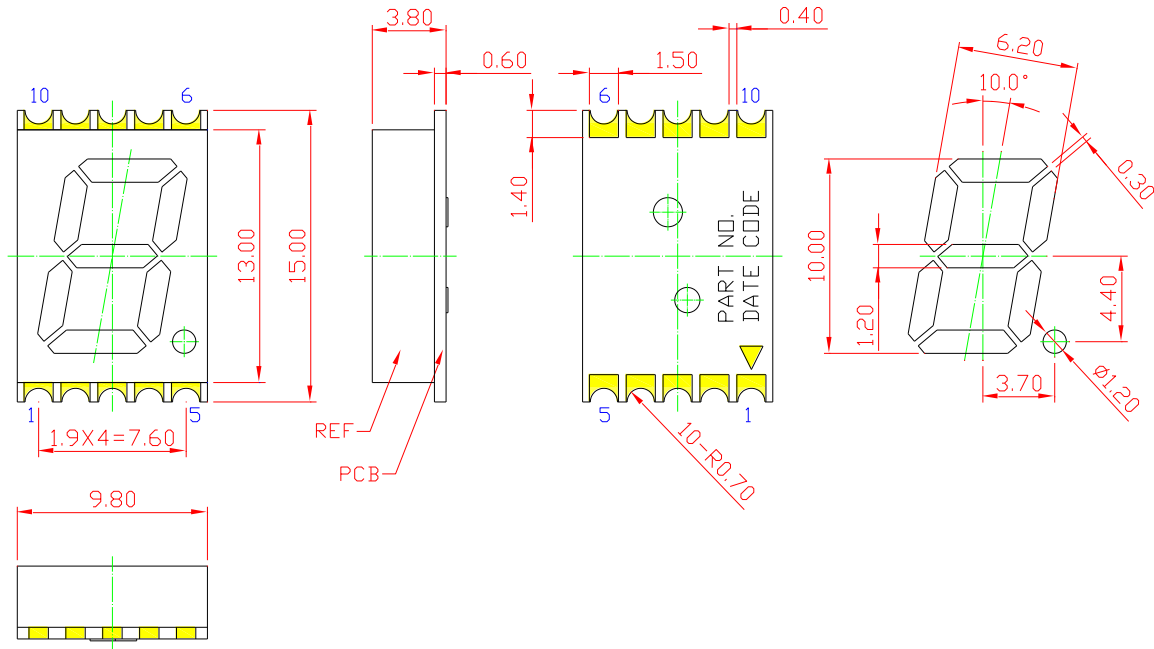

NOTE:
Dimension in millimeters (inches),
And tolerance are $\pm 0.25\text{mm}$ (.01") specified.

TYPICAL INTERNAL EQUIVALENT CIRCUIT

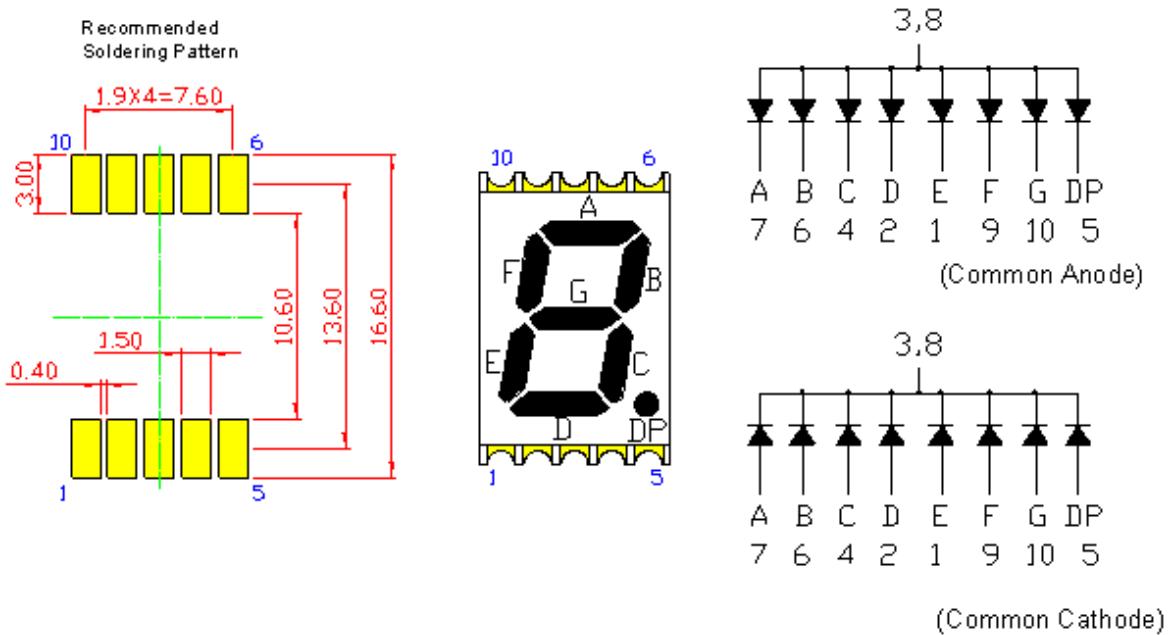



American Opto Plus LED Corp.
0.39" SMD Type LED Display
SMA391W G/W
SMC391W G/W

● **W: SUPER BRIGHT WHITE (InGaN/GaN)**

ABSOLUTE MAXIMUM RATING AT $T_a=25^{\circ}\text{C}$

Parameter	Symbol	Maximum Rating	Unit
Power dissipation	P_{AD}	120	mW
Derating liner from 25°C	-	0.3	mA / °C
Continuous forward current	I_{AF}	30	mA
Peak current (duty cycle 1/10, 1kHz)	I_{PF}	100	mA
Reverse voltage	V_R	5	V
Operating temperature	T_{OPR}	-40 to +105	°C
Storage temperature	T_{STG}	-40 to +105	°C

ELECTRICAL - OPTICAL CHARACTERISTICS AT $T_a=25^{\circ}\text{C}$

Characteristic	Symbol	Condition	Min.	Type.	Max.	Unit
Forward voltage	V_F	$I_F=5\text{mA}$	-	3.2	4.0	V
Reverse current	I_R	$V_R=8\text{V}$	-	-	10	μA
Chromaticity coordinate	X	$I_F=5\text{mA}$	-	0.29	-	-
	Y	$I_F=5\text{mA}$	-	0.29	-	-
Luminous intensity	I_V	$I_F=5\text{mA}$	-	35	-	mcd
Spectral radiation bandwidth	$\Delta\lambda$	$I_F=5\text{mA}$	-	30	-	nm



American Opto Plus LED Corp.

0.39" SMD Type LED Display

SMA391W G/W

SMC391W G/W

● W: SUPER BRIGHT WHITE (InGaN/GaN) CURVE

Typical Electro-optical Characteristic Curves
(25 °C Free Air Temperature Unless Otherwise Specified)

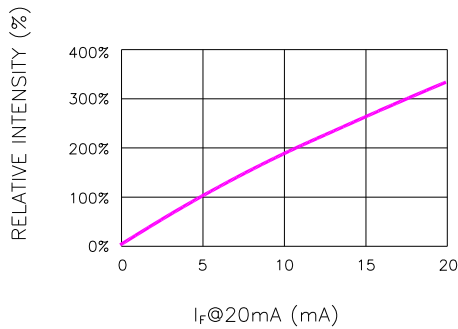

Fig.1 RELATIVE INTENSITY VS. FORWARD CURRENT

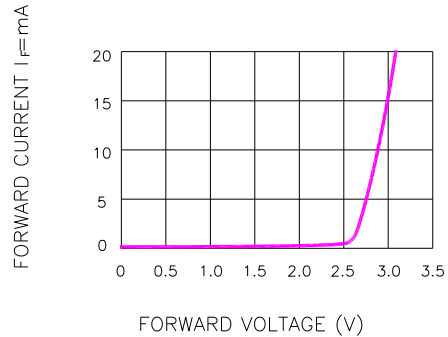

Fig.2 FORWARD CURRENT VS. FORWARD VOLTAGE

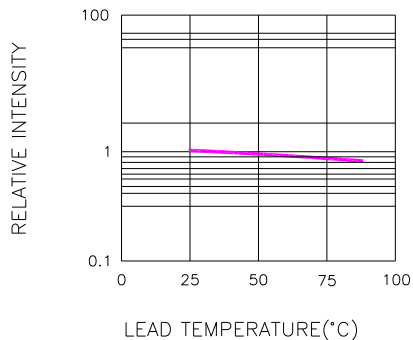

Fig.3 RELATIVE INTENSITY VS. LEAD TEMPERATURE
(PULSED 20 mA; 300us PULSE, 10ms PERIOD)

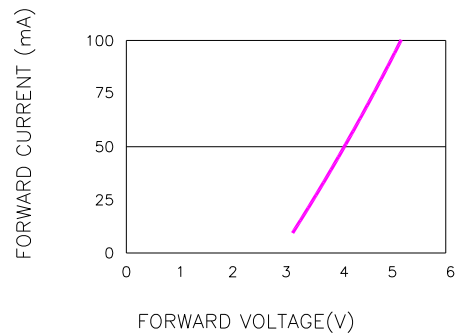

Fig.4 PEAK FORWARD VOLTAGE VS. FORWARD (100us TEST PULSE, 1% DUTY CYCLE)

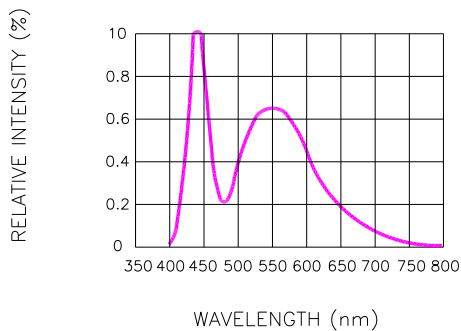

Fig.4 RELATIVE INTENSITY VS. WAVELENGTH

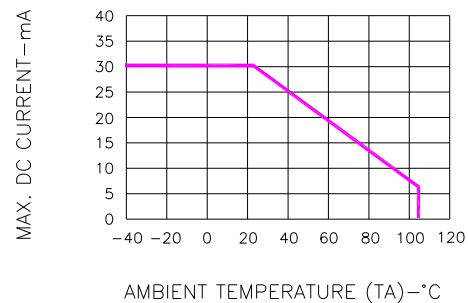

Fig.7 MAX. ALLOWABLE DC CURRENT VS. AMBIENT TEMPERATURE



American Opto Plus LED Corp.
0.39" SMD Type LED Display
SMA391W G/W
SMC391W G/W

● **RECOMMEND SOLDERING PROFILE**

SMT Soldering Profile

Pb free reflow soldering Profile

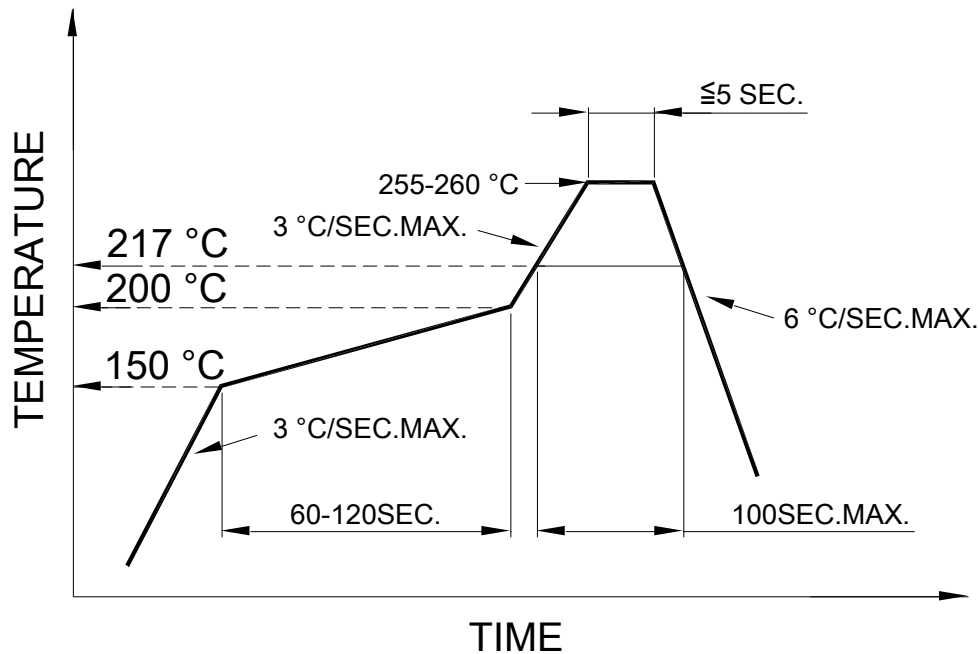

● **SOLDERING IRON**

Basic specification : ≤ 4 seconds when 260°C, If temperature is higher, time should be shorter (+10°C→1 sec). Power dissipation of iron should be smaller than 15W, and temperature should be controllable. Surface temperature of the device should be under 230°C.

● **REWORK**

Customer must finish rework within ≤ 3 sec under 350°C.