

CONNECTION DIAGRAM:

IMPORTANT NOTE:

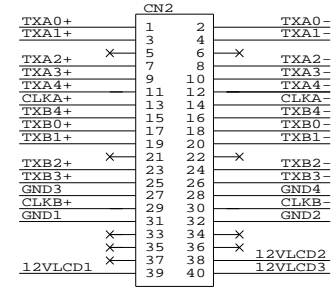
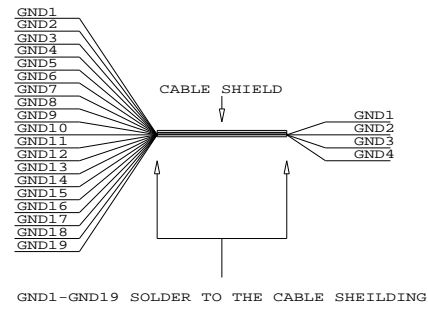
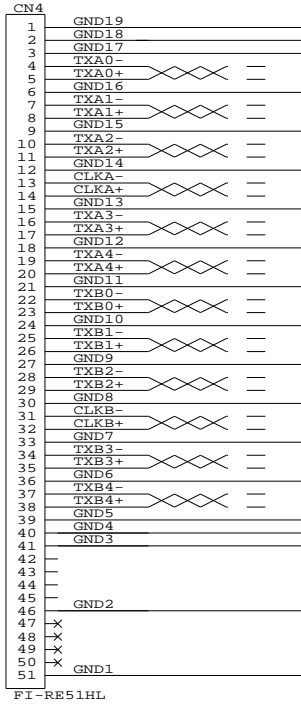
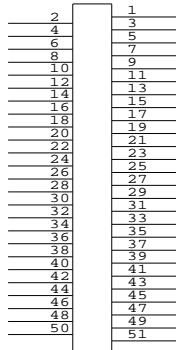

DF13-40DS-1.25C

CONTROLLER SIDE

CONSTRUCTION DIAGRAM:

JAE CONNECTOR FEMALE



CABLE
VIEW FROM 'A'

USAGE: IE-1000 FOR NL192120BC25-03

P/N 426497900-3

LVDS ROUND TWISTED PAIR CABLE: FOR NL192120BC25-03, 610MM

RoHS COMPLIANCE

DIGITAL VIEW LTD. COPYRIGHT 2008, ALL RIGHTS RESERVED CONFIDENTIAL DRAWN BY: VICTOR NG		
Title ROUND PAIRED CABLE: NL192120BC25-03		
Size	Document Number	REV
B	(...\DV\DV_CABLE\C6497900.SCH)	00
Date:	October 22, 2008	Sheet 1 of 2

CONNECTION DIAGRAM:

IMPORTANT NOTE:

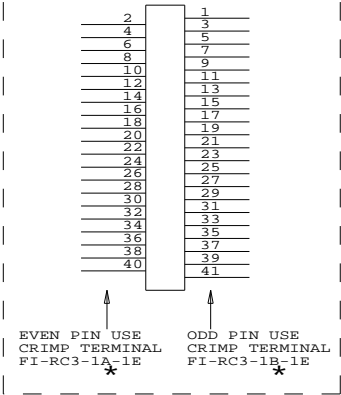

FI-RE41HL

CN1
IL-Z-12S-S125C3
(OR COMPATIBLE)

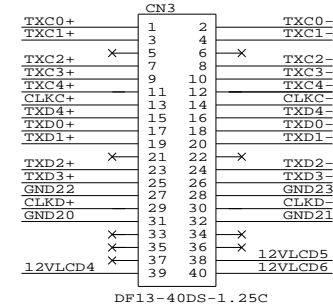
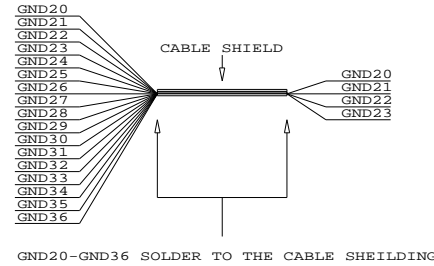
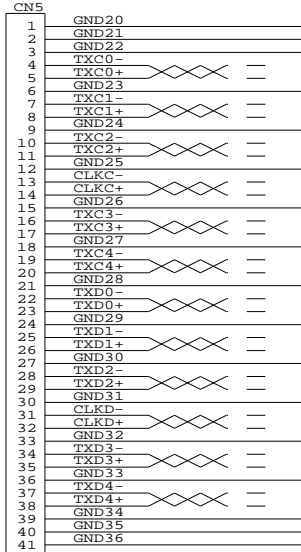

HEAT SHRINKABLE TUBE CONTROLLER SIDE

ADD SOLDER JOIN

FAST ON 6.25X0.8MM COVERED WITH HEAT SHRINKABLE TUBE

CONSTRUCTION DIAGRAM:

JAE CONNECTOR FEMALE

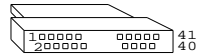

VIEW FROM 'A'

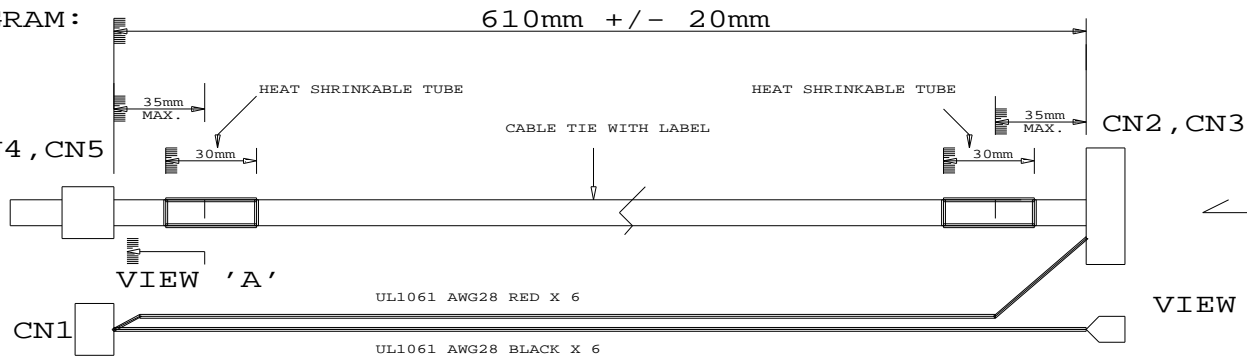

DF13-40DS-1.25C

HIROSE

HS1 PIN ASSIGNMENT VIEW FROM 'A'

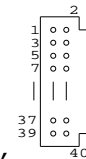

VIEW 'A'

RoHS COMPLIANCE

CABLE CN2-CN4, CN3-CN5: UL20276, 12 PAIRS, 30AWG, PVC BLACK

GND1-36 USE INDIVIDUAL UL20276 WIRE 30AWG

USAGE: IE-1000 WITH NL192120BC25-03 120HZ PANEL

P/N 426497900-3

LVDS ROUND TWISTED PAIR CABLE: FOR NL192120BC25-03, 610MM

DIGITAL VIEW LTD. COPYRIGHT 2008, ALL RIGHTS RESERVED CONFIDENTIAL DRAWN BY: VICTOR NG		
Title	ROUND PAIRED CABLE: NL192120BC25-03	
Size	Document Number	REV
B	(...\DV\DV_CABLE\C6498000.SCH)	00
Date:	October 22, 2008	Sheet 2 of 2