

# E3M0120090J

## Silicon Carbide Power MOSFET

### E-Series Automotive

#### N-Channel Enhancement Mode



#### Features

- 3rd generation of SiC MOSFET technology
- High blocking voltage with low On-resistance
- High speed switching with low capacitances
- Fast intrinsic diode with low reverse recovery (Q<sub>rr</sub>)
- Halogen free, RoHS compliant
- Wide creepage (~7mm) between drain and source
- Automotive qualified (AEC-Q101) and PPAP capable

#### Benefits

- Reduce switching losses and minimize gate ringing
- High system efficiency
- Increased power density
- Increased system switching frequency

#### Applications

- EV charging
- DC/DC converters
- SMPS
- UPS
- Solar PV inverters

#### Package

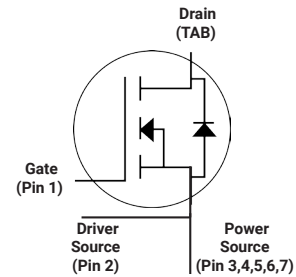
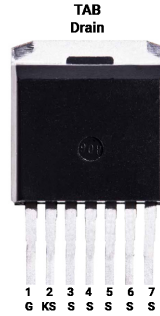

Part Number	Package	Marking
E3M0120090J	TO-263-7	E3M0120090J

#### Maximum Ratings (T<sub>c</sub> = 25 °C unless otherwise specified)

Symbol	Parameter	Value	Unit	Test Conditions	Note
V <sub>DSmax</sub>	Drain - Source Voltage	900	V	V <sub>GS</sub> = 0 V, I <sub>D</sub> = 100 μA	
V <sub>GSmax</sub>	Gate - Source Voltage	-8/+19	V	Absolute maximum values	
V <sub>GSop</sub>	Gate - Source Voltage	-4/+15	V	Recommended operational values	Note (1)
I <sub>D</sub>	Continuous Drain Current	22	A	V <sub>GS</sub> = 15 V, T <sub>C</sub> = 25 °C	Fig. 19
		14		V <sub>GS</sub> = 15 V, T <sub>C</sub> = 100 °C	
I <sub>D(pulse)</sub>	Pulsed Drain Current	50	A	Pulse width t <sub>p</sub> limited by T <sub>Jmax</sub>	Fig. 22
P <sub>D</sub>	Power Dissipation	83	W	T <sub>C</sub> = 25 °C, T <sub>J</sub> = 150 °C	Fig. 20
T <sub>J</sub> , T <sub>stg</sub>	Operating Junction and Storage Temperature	-55 to +150	°C		
T <sub>L</sub>	Solder Temperature	260	°C	1.6mm (0.063") from case for 10s	

Note (1): MOSFET can also safely operate at 0/+15 V

Symbol	Parameter	Min.	Typ.	Max.	Unit	Test Conditions	Note
$V_{(BR)DSS}$	Drain-Source Breakdown Voltage	900			V	$V_{GS} = 0\text{ V}, I_D = 100\ \mu\text{A}$	
$V_{GS(th)}$	Gate Threshold Voltage	1.8	2.1	3.5	V	$V_{DS} = V_{GS}, I_D = 3\ \text{mA}$	Fig. 11
			1.6		V	$V_{DS} = V_{GS}, I_D = 3\ \text{mA}, T_J = 150^\circ\text{C}$	
$I_{DSS}$	Zero Gate Voltage Drain Current		1	100	$\mu\text{A}$	$V_{DS} = 900\ \text{V}, V_{GS} = 0\ \text{V}$	
$I_{GSS}$	Gate-Source Leakage Current		10	250	nA	$V_{GS} = 15\ \text{V}, V_{DS} = 0\ \text{V}$	
$R_{DS(on)}$	Drain-Source On-State Resistance		120	155	m $\Omega$	$V_{GS} = 15\ \text{V}, I_D = 15\ \text{A}$	Fig. 4, 5, 6
			170			$V_{GS} = 15\ \text{V}, I_D = 15\ \text{A}, T_J = 150^\circ\text{C}$	
$g_{fs}$	Transconductance		8.9		S	$V_{DS} = 15\ \text{V}, I_{DS} = 15\ \text{A}$	Fig. 7
			7.1			$V_{DS} = 15\ \text{V}, I_{DS} = 15\ \text{A}, T_J = 150^\circ\text{C}$	
$C_{iss}$	Input Capacitance		414		pF	$V_{GS} = 0\ \text{V}, V_{DS} = 600\ \text{V}$ $f = 1\ \text{MHz}$ $V_{AC} = 25\ \text{mV}$	Fig. 17, 18
$C_{oss}$	Output Capacitance		48				
$C_{rss}$	Reverse Transfer Capacitance		3				
$E_{oss}$	$C_{oss}$ Stored Energy		10.6		$\mu\text{J}$		Fig. 16
$E_{ON}$	Turn-On Switching Energy		32		$\mu\text{J}$	$V_{DS} = 400\ \text{V}, V_{GS} = -4\ \text{V}/15\ \text{V}, I_D = 15\ \text{A},$ $R_{G(ext)} = 2.5\ \Omega, L = 99\ \mu\text{H}, T_J = 150^\circ\text{C}$	Fig. 26, 29
$E_{OFF}$	Turn Off Switching Energy		8				
$t_{d(on)}$	Turn-On Delay Time		5		ns	$V_{DD} = 400\ \text{V}, V_{GS} = -4\ \text{V}/15\ \text{V}$ $I_D = 15\ \text{A}, R_{G(ext)} = 2.5\ \Omega,$ Timing relative to $V_{DS}$ Inductive load	Fig. 27, 29
$t_r$	Rise Time		8				
$t_{d(off)}$	Turn-Off Delay Time		13				
$t_f$	Fall Time		4				
$R_{G(int)}$	Internal Gate Resistance		13		$\Omega$	$f = 1\ \text{MHz}, V_{AC} = 25\ \text{mV}$	
$Q_{gs}$	Gate to Source Charge		6		nC	$V_{DS} = 400\ \text{V}, V_{GS} = -4\ \text{V}/15\ \text{V}$ $I_D = 15\ \text{A}$ Per IEC60747-8-4 pg 21	Fig. 12
$Q_{gd}$	Gate to Drain Charge		5				
$Q_g$	Total Gate Charge		18				

**Reverse Diode Characteristics** ( $T_c = 25^\circ\text{C}$  unless otherwise specified)

Symbol	Parameter	Typ.	Max.	Unit	Test Conditions	Note
$V_{SD}$	Diode Forward Voltage	4.8		V	$V_{GS} = -4\ \text{V}, I_{SD} = 7.5\ \text{A}$	Fig. 8, 9, 10
		4.4		V	$V_{GS} = -4\ \text{V}, I_{SD} = 7.5\ \text{A}, T_J = 150^\circ\text{C}$	
$I_S$	Continuous Diode Forward Current		15	A	$V_{GS} = -4\ \text{V}$	Note (2)
$I_{S,pulse}$	Diode pulse Current		50	A	$V_{GS} = -4\ \text{V}$ , pulse width $t_p$ limited by $T_{jmax}$	Note (2)
$t_{rr}$	Reverse Recover time	10		ns	$V_{GS} = -4\ \text{V}, I_{SD} = 15\ \text{A}, V_R = 400\ \text{V}$ $\text{dif}/\text{dt} = 900\ \text{A}/\mu\text{s}, T_J = 150^\circ\text{C}$	Note (2)
$Q_{rr}$	Reverse Recovery Charge	72		nC		
$I_{rrm}$	Peak Reverse Recovery Current	12		A		

 Note (2): When using SiC Body Diode the maximum recommended  $V_{GS} = -4\text{V}$ 
**Thermal Characteristics**

Symbol	Parameter	Max.	Unit	Test Conditions	Note
$R_{\theta JC}$	Thermal Resistance from Junction to Case	1.5	$^\circ\text{C}/\text{W}$		Fig. 21
$R_{\theta JA}$	Thermal Resistance From Junction to Ambient	40			

## Typical Performance

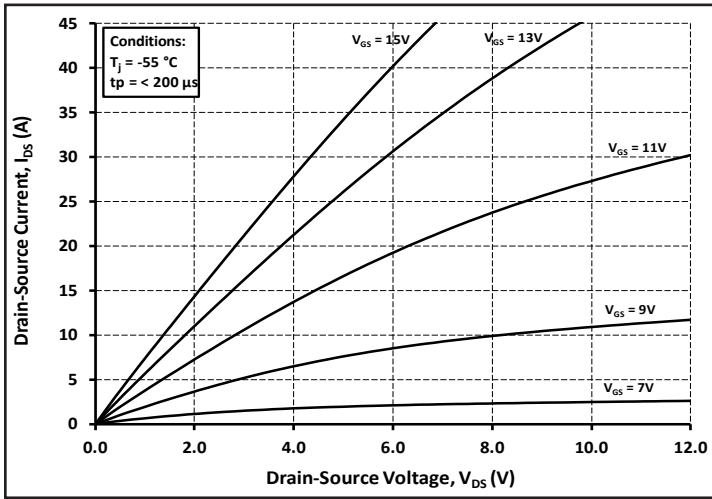

Figure 1. Output Characteristics  $T_J = -55\text{ }^\circ\text{C}$

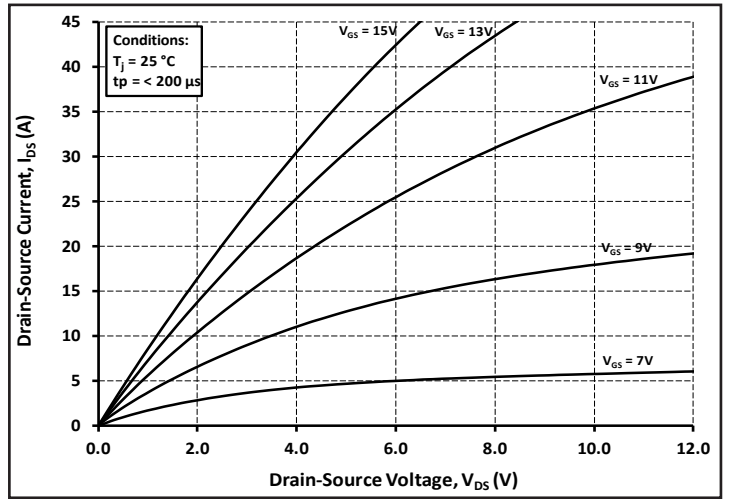

Figure 2. Output Characteristics  $T_J = 25\text{ }^\circ\text{C}$

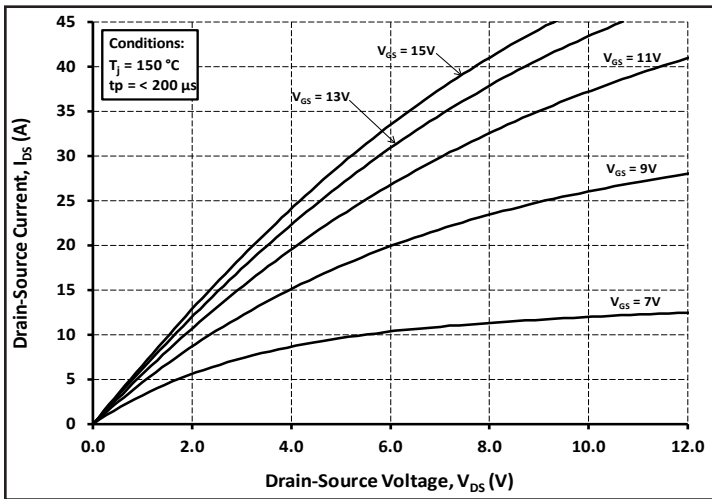

Figure 3. Output Characteristics  $T_J = 150\text{ }^\circ\text{C}$

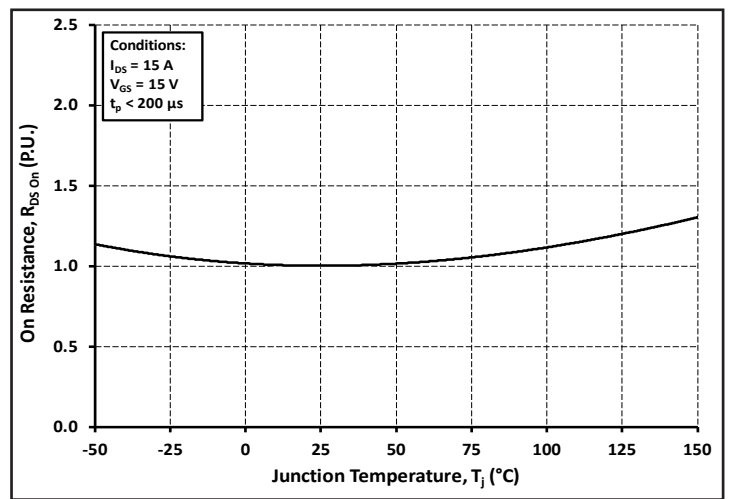

Figure 4. Normalized On-Resistance vs. Temperature

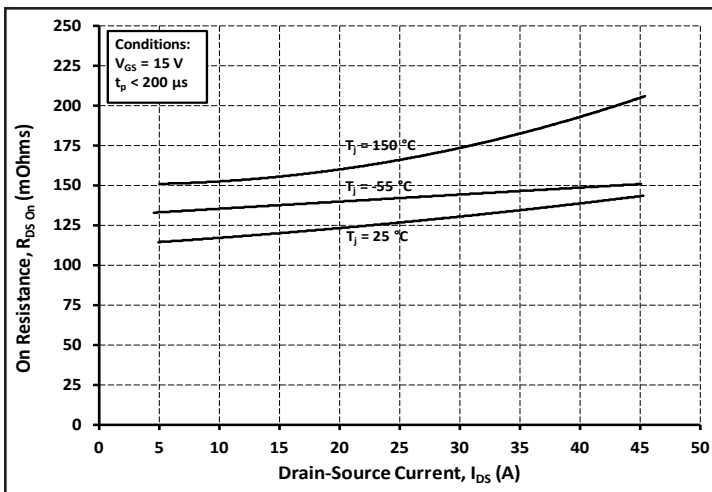

Figure 5. On-Resistance vs. Drain Current For Various Temperatures

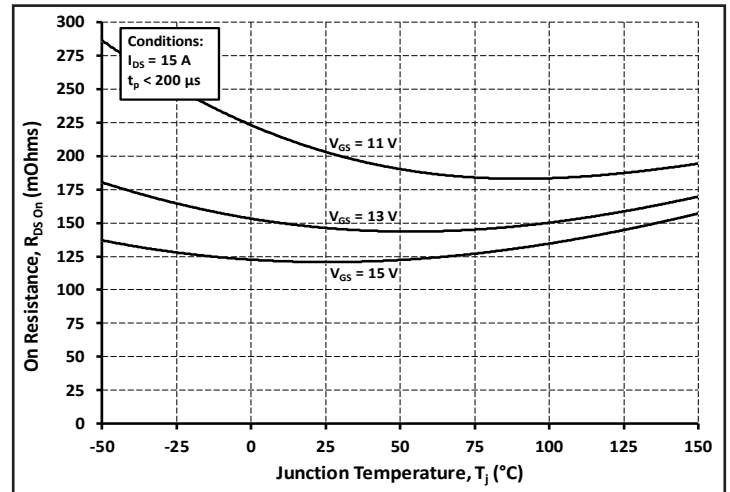

Figure 6. On-Resistance vs. Temperature For Various Gate Voltage

## Typical Performance

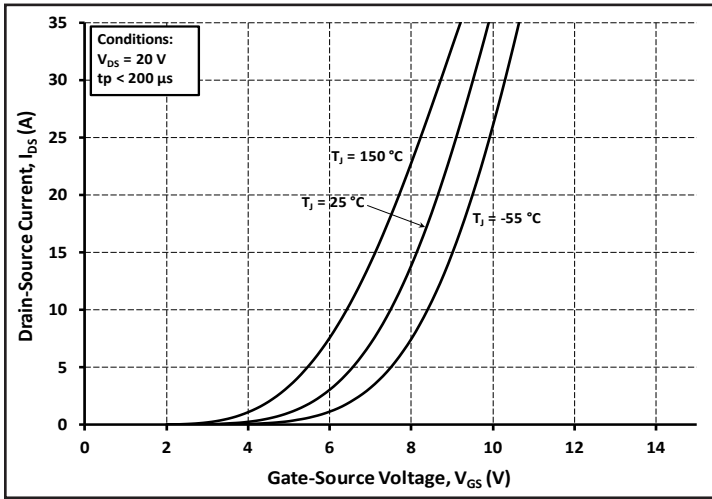

Figure 7. Transfer Characteristic for Various Junction Temperatures

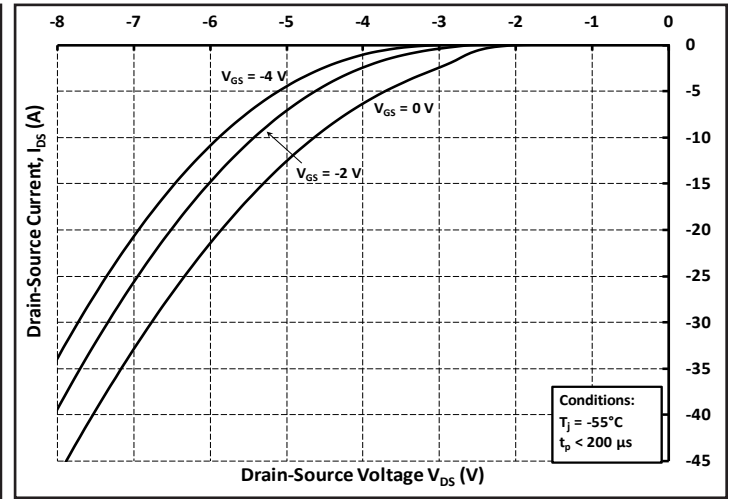

Figure 8. Body Diode Characteristic at -55 °C

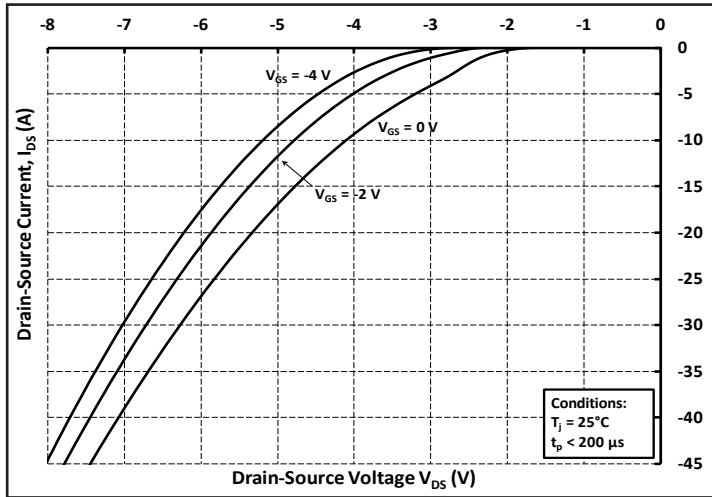

Figure 9. Body Diode Characteristic at 25 °C

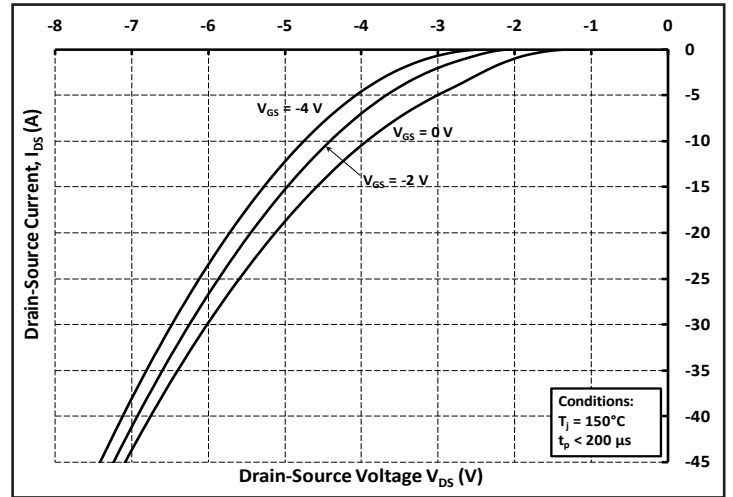

Figure 10. Body Diode Characteristic at 150 °C

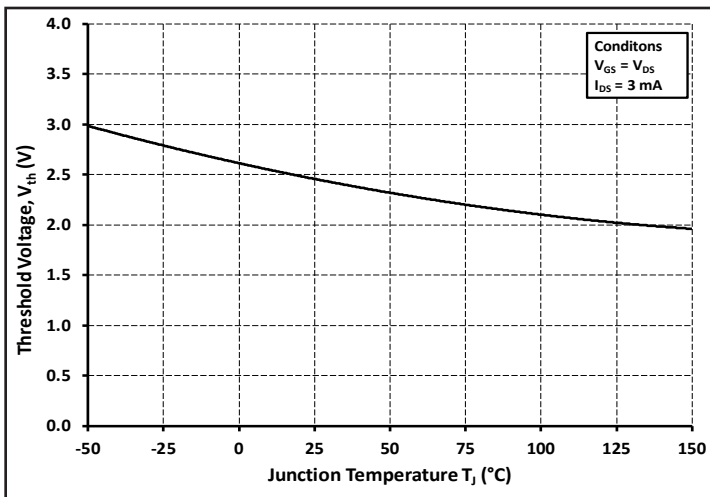

Figure 11. Threshold Voltage vs. Temperature

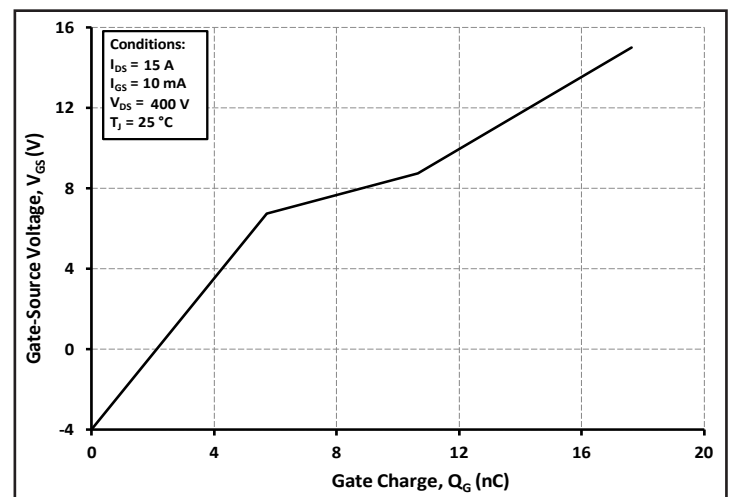

Figure 12. Gate Charge Characteristics

## Typical Performance

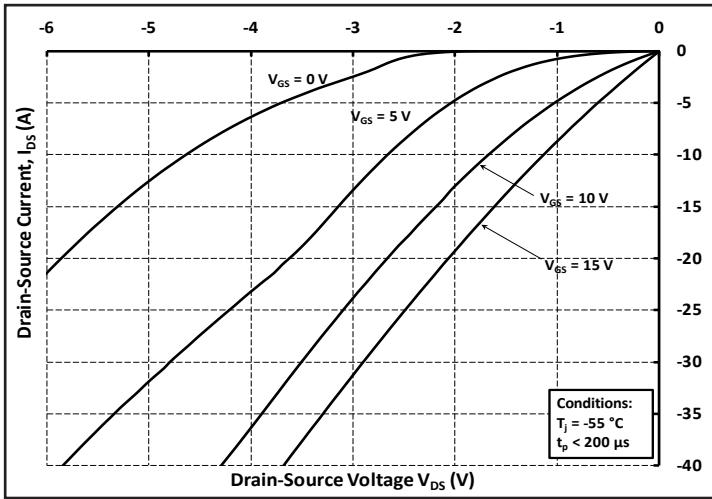

Figure 13. 3rd Quadrant Characteristic at  $-55\text{ }^\circ\text{C}$

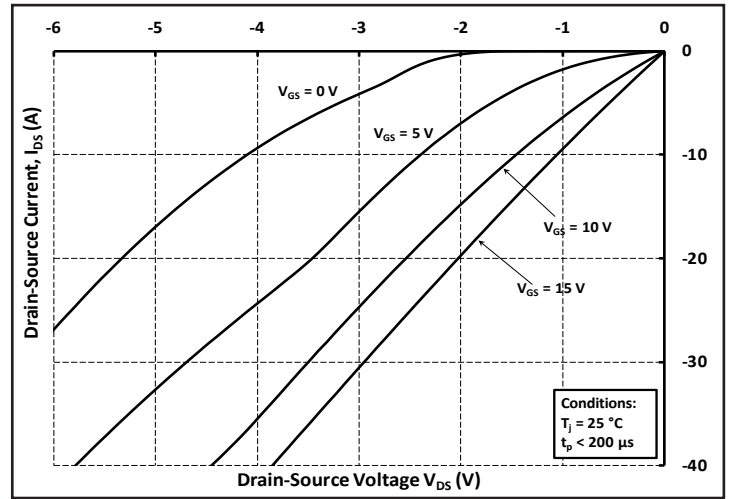

Figure 14. 3rd Quadrant Characteristic at  $25\text{ }^\circ\text{C}$

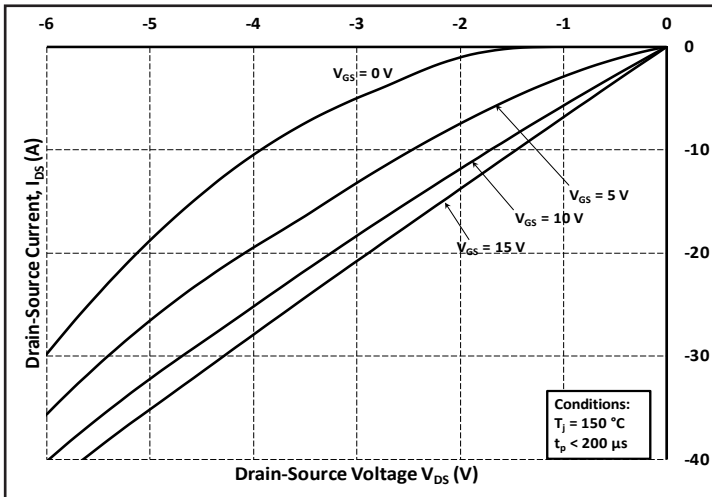

Figure 15. 3rd Quadrant Characteristic at  $150\text{ }^\circ\text{C}$

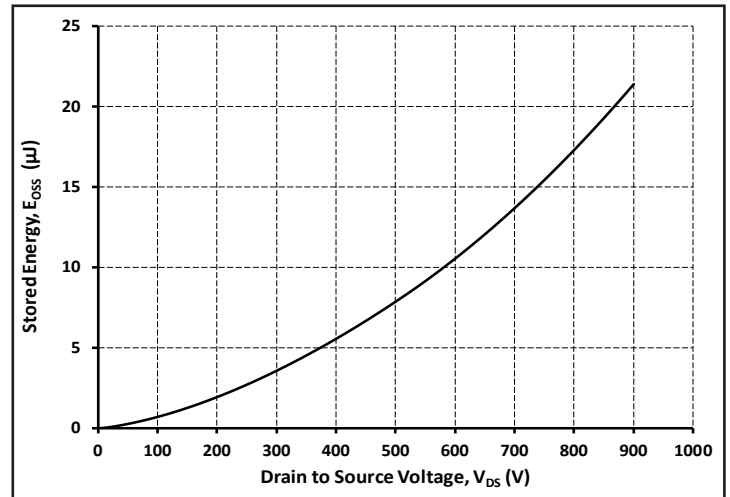

Figure 16. Output Capacitor Stored Energy

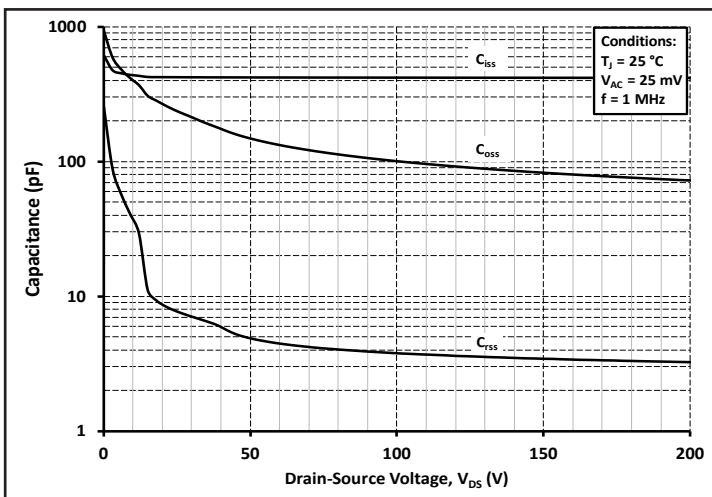

Figure 17. Capacitances vs. Drain-Source Voltage (0 - 200V)

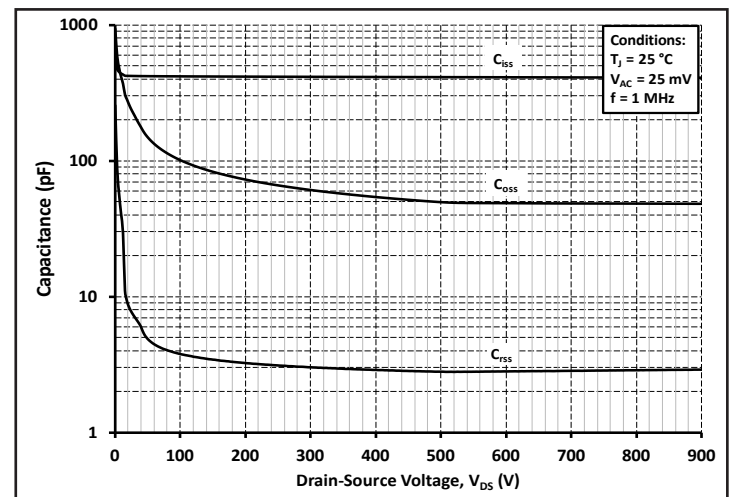

Figure 18. Capacitances vs. Drain-Source Voltage (0 - 900V)

## Typical Performance

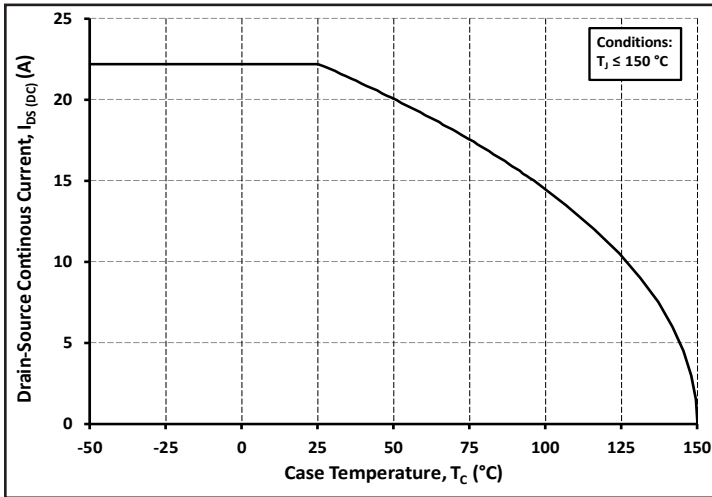

Figure 19. Continuous Drain Current Derating vs. Case Temperature

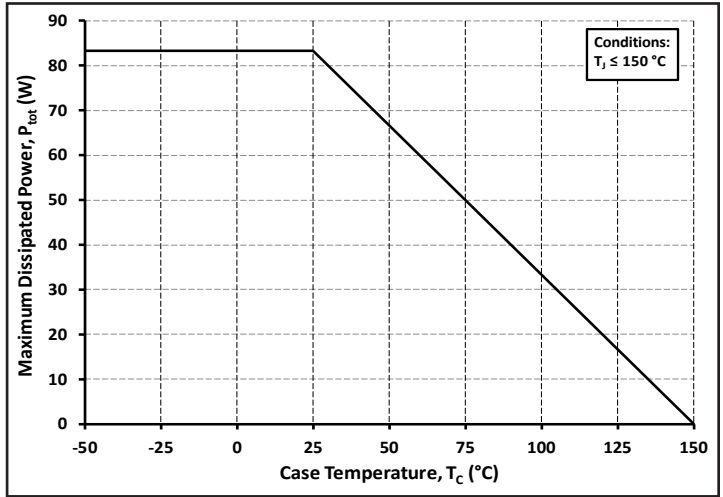

Figure 20. Maximum Power Dissipation Derating vs. Case Temperature

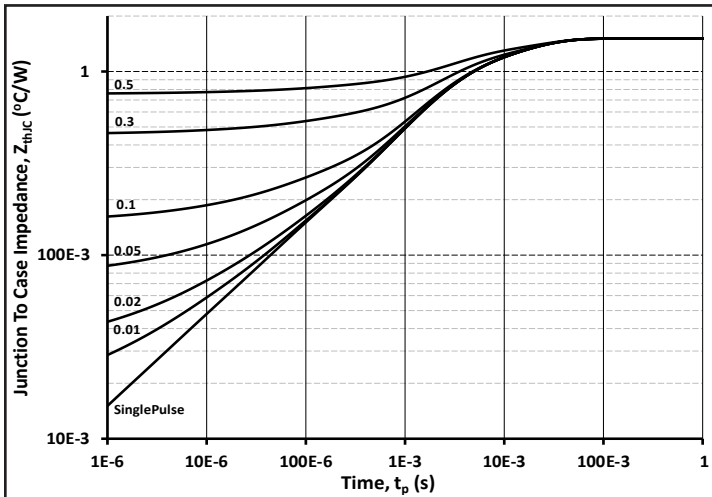

Figure 21. Transient Thermal Impedance (Junction - Case)

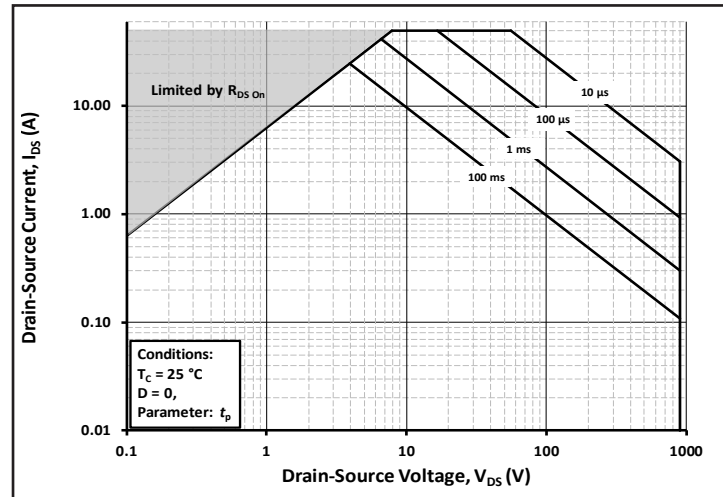

Figure 22. Safe Operating Area

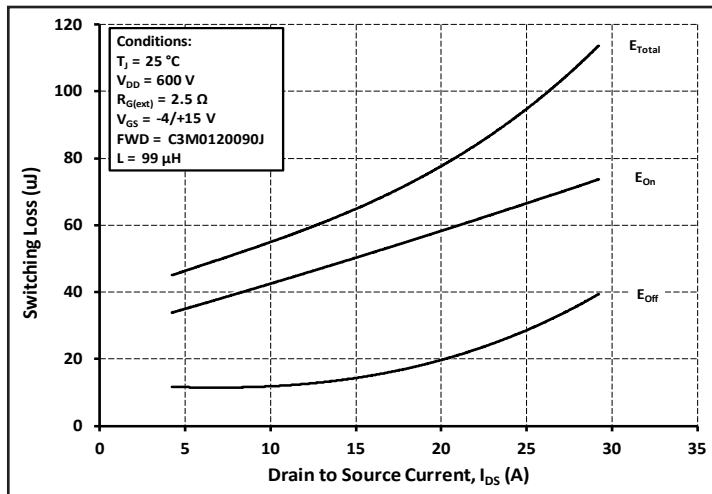

Figure 23. Clamped Inductive Switching Energy vs. Drain Current ( $V_{DD} = 600V$ )

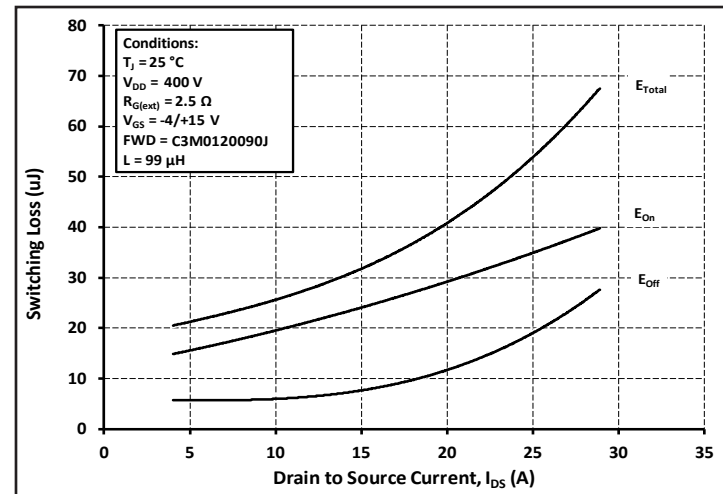

Figure 24. Clamped Inductive Switching Energy vs. Drain Current ( $V_{DD} = 400V$ )

## Typical Performance

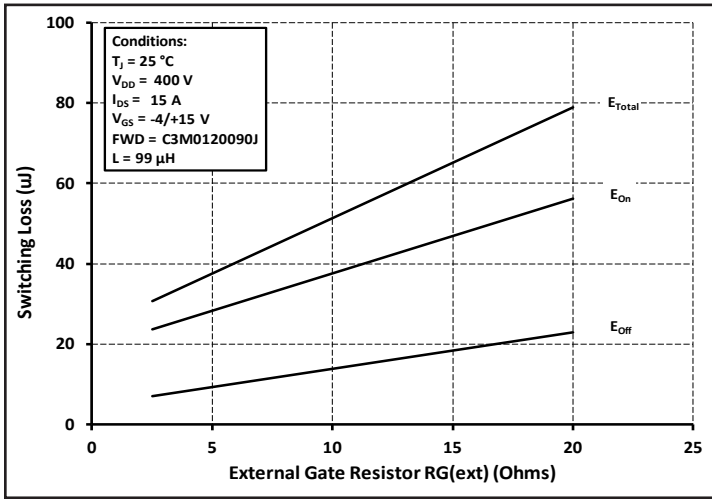

Figure 25. Clamped Inductive Switching Energy vs.  $R_{G(\text{ext})}$

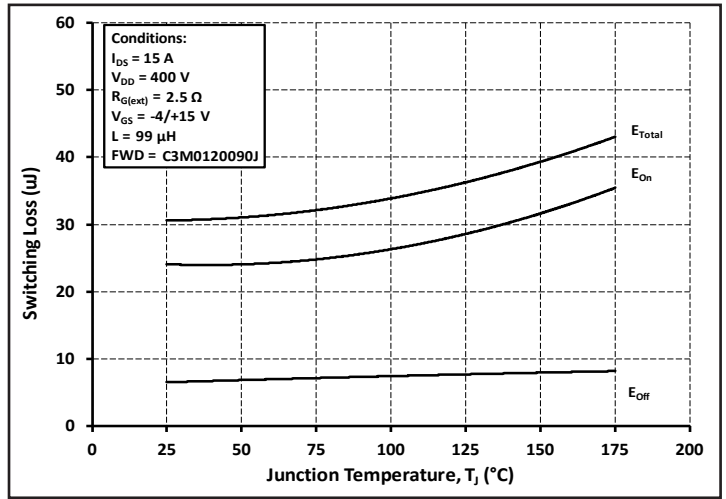

Figure 26. Clamped Inductive Switching Energy vs. Temperature

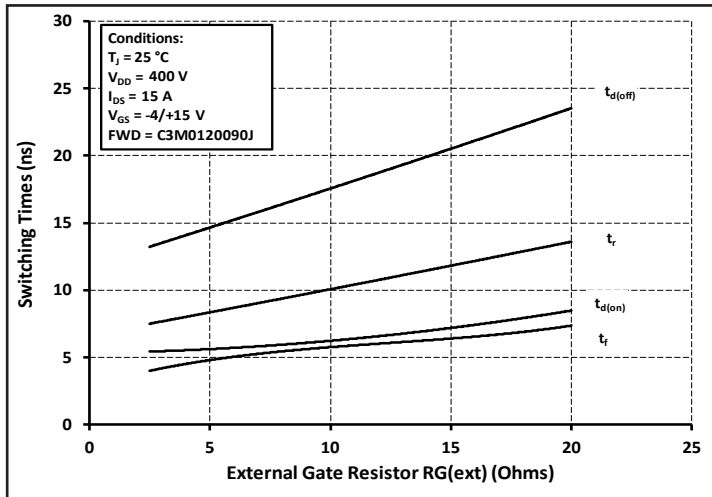

Figure 27. Switching Times vs.  $R_{G(\text{ext})}$

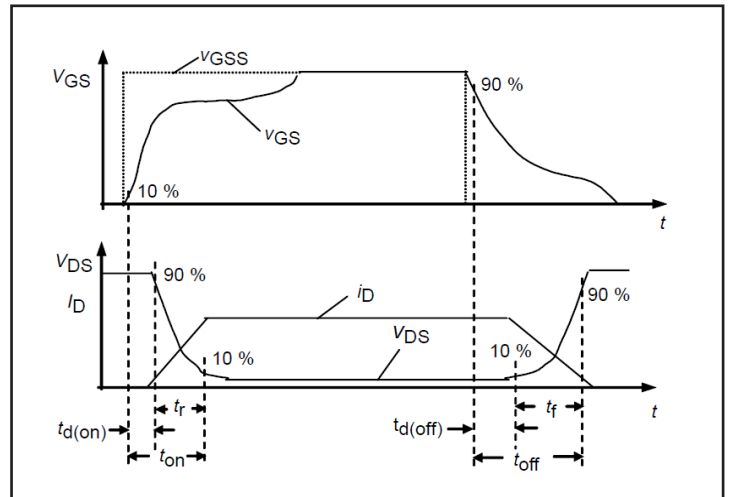

Figure 28. Switching Times Definition

## Test Circuit Schematic

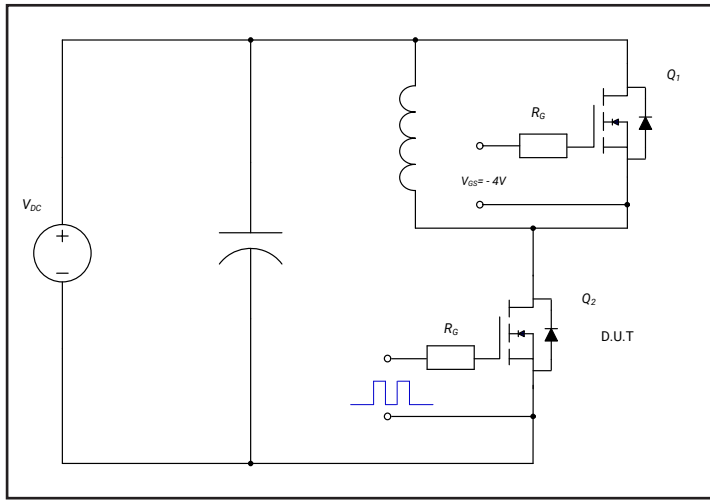

Figure 29. Clamped Inductive Switching Test Circuit

Note (3): Turn-off and Turn-on switching energy and timing values measured using SiC MOSFET Body Diode as shown above.





## Notes

---

- **RoHS Compliance**  
The levels of RoHS restricted materials in this product are below the maximum concentration values (also referred to as the threshold limits) permitted for such substances, or are used in an exempted application, in accordance with EU Directive 2011/65/EC (RoHS2), as implemented January 2, 2013. RoHS Declarations for this product can be obtained from your Cree representative or from the Product Documentation sections of [www.cree.com](http://www.cree.com).
- **REACH Compliance**  
REACH substances of high concern (SVHCs) information is available for this product. Since the European Chemical Agency (ECHA) has published notice of their intent to frequently revise the SVHC listing for the foreseeable future, please contact a Cree representative to insure you get the most up-to-date REACH SVHC Declaration. REACH banned substance information (REACH Article 67) is also available upon request.
- This product has not been designed or tested for use in, and is not intended for use in, applications implanted into the human body nor in applications in which failure of the product could lead to death, personal injury or property damage, including but not limited to equipment used in the operation of nuclear facilities, life-support machines, cardiac defibrillators or similar emergency medical equipment, aircraft navigation or communication or control systems, air traffic control systems.

## Related Links

---

- **C2M PSPICE Models:** <http://wolfspeed.com/power/tools-and-support>
- **SiC MOSFET Isolated Gate Driver reference design:** <http://wolfspeed.com/power/tools-and-support>
- **SiC MOSFET Evaluation Board:** <http://wolfspeed.com/power/tools-and-support>