

Silicon Carbide (SiC) Module – EliteSiC, 2 x 10 mohm SiC M1 MOSFET, 1200 V, 2 x 100 A, Vienna Module 900 V, F2 Package

NXH020U90MNF2PTG

The NXH020U90MNF2 is a power module containing a Vienna Rectifier module consisting of two 10 mΩ, 900 V SiC MOSFETs, two 100 A, 1200 V SiC diodes and a thermistor in an F2 package.

Features

- Neutral Point: 10 mΩ, 900 V SiC MOSFETs
- Boost Diodes: 100 A, 1200 V SiC Diodes
- Thermistor
- Pre-Applied TIM
- Press-Fit Pins
- These Devices are Pb-Free, Halide Free and are RoHS Compliant

Typical Applications

- Electric Vehicle Charging Stations
- Uninterruptible Power Supplies
- Energy Storage Systems

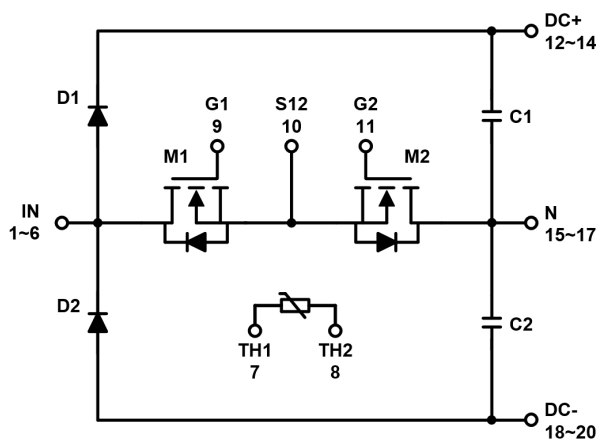
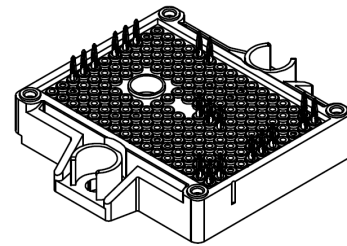

Figure 1. NXH020U90MNF2 Schematic Diagram

PACKAGE PICTURE



PIM20 56.7x42.5 (PRESS FIT)
CASE 180BZ

MARKING DIAGRAM

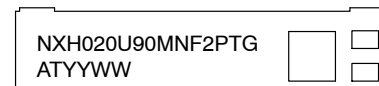

NXH020U90MNF2PTG = Specific Device Code
G = Pb-Free Package
AT = Assembly & Test Site Code
YYWW = Year and Work Week Code

PIN CONNECTIONS

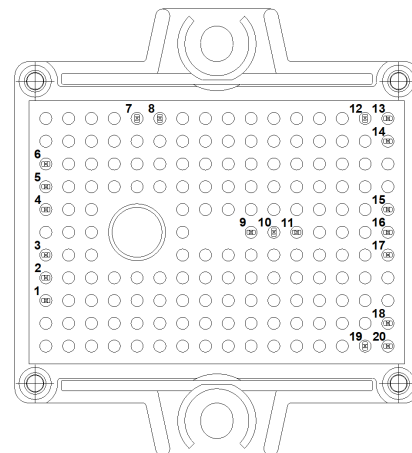

See Pin Function Description for pin names

ORDERING INFORMATION

See detailed ordering and shipping information on page 5 of this data sheet.

NXH020U90MNF2PTG

PIN FUNCTION DESCRIPTION

Pin	Name	Description
1	IN	Phase Connection
2	IN	Phase Connection
3	IN	Phase Connection
4	IN	Phase Connection
5	IN	Phase Connection
6	IN	Phase Connection
7	TH1	Thermistor Connection 1
8	TH2	Thermistor Connection 2
9	G1	M1 Gate
10	S12	Common Source M1 M2
11	G2	M2 Gate
12	DC+	DC Positive Bus connection
13	DC+	DC Positive Bus connection
14	DC+	DC Positive Bus connection
15	N	N connection
16	N	N connection
17	N	N connection
18	DC-	DC Negative Bus connection
19	DC-	DC Negative Bus connection
20	DC-	DC Negative Bus connection

NXH020U90MNF2PTG

MAXIMUM RATINGS

Rating	Symbol	Value	Unit
SiC MOSFET			
Drain–Source Voltage	V_{DSS}	900	V
Gate–Source Voltage	V_{GS}	+18/–8	V
Continuous Drain Current @ $T_c = 80^\circ\text{C}$ ($T_J = 175^\circ\text{C}$)	I_D	149	A
Pulsed Drain Current ($T_J = 175^\circ\text{C}$)	I_{Dpulse}	447	A
Maximum Power Dissipation ($T_J = 175^\circ\text{C}$)	P_{tot}	352	W
Minimum Junction Temperature	T_{JMIN}	–40	$^\circ\text{C}$
Maximum Junction Temperature	T_{JMAX}	175	$^\circ\text{C}$

SiC DIODE

Peak Repetitive Reverse Voltage	V_{RRM}	1200	V
Continuous Forward Current @ $T_c = 80^\circ\text{C}$ ($T_J = 175^\circ\text{C}$)	I_F	118	A
Surge Forward Current, $t_p = 10\text{ ms}$	I_{FSM}	354	A
Power Dissipation per Diode ($T_J = 175^\circ\text{C}$, $T_c = 80^\circ\text{C}$)	P_{tot}	365	W
Minimum Operating Junction Temperature	T_{JMIN}	–40	$^\circ\text{C}$
Maximum Operating Junction Temperature	T_{JMAX}	175	$^\circ\text{C}$

THERMAL PROPERTIES

Maximum Operating Junction Temperature under Switching Conditions	T_{VJOP}	150	$^\circ\text{C}$
Storage Temperature Range	T_{stg}	–40 to 150	$^\circ\text{C}$
TIM Layer Thickness	T_{TIM}	160 ± 20	μm

INSULATION PROPERTIES

Isolation test voltage, $t = 1\text{ sec}$, 60 Hz	V_{is}	4800	V_{RMS}
Creepage distance		12.7	mm
CTI		600	
Substrate Ceramic Material		HPS	
Substrate Ceramic Material Thickness		0.38	mm
Substrate Warpage (Note 2)	W	Max 0.18	mm

Stresses exceeding those listed in the Maximum Ratings table may damage the device. If any of these limits are exceeded, device functionality should not be assumed, damage may occur and reliability may be affected.

1. Refer to ELECTRICAL CHARACTERISTICS, RECOMMENDED OPERATING RANGES and/or APPLICATION INFORMATION for Safe Operating parameters.
2. Height difference between horizontal plane and substrate bottom copper.

ELECTRICAL CHARACTERISTICS

$T_J = 25^\circ\text{C}$ unless otherwise noted

Parameter	Test Conditions	Symbol	Min	Typ	Max	Unit
SiC MOSFET CHARACTERISTICS (M1, M2)						
Drain–Source Breakdown Voltage	$V_{GS} = 0\text{ V}$, $I_D = 200\ \mu\text{A}$	$V_{(BR)DSS}$	900	–	–	V
Zero Gate Voltage Drain Current	$V_{GS} = 0\text{ V}$, $V_{DS} = 900\text{ V}$	I_{DSS}	–	–	300	μA
Drain–Source On Resistance	$V_{GS} = 15\text{ V}$, $I_D = 100\text{ A}$, $T_J = 25^\circ\text{C}$	$R_{DS(ON)}$	–	10.03	14	$\text{m}\Omega$
	$V_{GS} = 15\text{ V}$, $I_D = 100\text{ A}$, $T_J = 125^\circ\text{C}$		–	10.80	–	
	$V_{GS} = 15\text{ V}$, $I_D = 100\text{ A}$, $T_J = 150^\circ\text{C}$		–	11.61	–	
Gate–Source Threshold Voltage	$V_{GS} = V_{DS}$, $I_D = 40\text{ mA}$	$V_{GS(TH)}$	1.8	2.74	4.3	V
Gate Leakage Current	$V_{GS} = -5\text{ V} / 15\text{ V}$, $V_{DS} = 0\text{ V}$	I_{GSS}	–1	–	1	μA

NXH020U90MNF2PTG

ELECTRICAL CHARACTERISTICS (continued)

T_J = 25 °C unless otherwise noted

Parameter	Test Conditions	Symbol	Min	Typ	Max	Unit
Input Capacitance	V _{DS} = 450 V, V _{GS} = 0 V, f = 1 MHz	C _{ISS}	–	7007	–	pF
Reverse Transfer Capacitance		C _{RSS}	–	44	–	
Output Capacitance		C _{OSS}	–	665	–	
Total Gate Charge	V _{DS} = 720 V, V _{GS} = -5 V / 15 V, I _D = 100 A	Q _{G(TOTAL)}	–	546.4	–	nC
Gate–Source Charge		Q _{GS}	–	105.45	–	nC
Gate–Drain Charge		Q _{GD}	–	122.7	–	nC
Turn-on Delay Time	T _J = 25°C V _{DS} = 450 V, I _D = 100 A V _{GS} = -5 V / 15 V, R _G = 2 Ω	t _{d(on)}	–	43.2	–	ns
Rise Time		t _r	–	19.8	–	
Turn-off Delay Time		t _{d(off)}	–	110	–	
Fall Time		t _f	–	12.8	–	
Turn-on Switching Loss per Pulse		E _{ON}	–	0.75	–	mJ
Turn-off Switching Loss per Pulse		E _{OFF}	–	0.71	–	
Turn-on Delay Time	T _J = 150°C V _{DS} = 450 V, I _D = 100 A V _{GS} = -5 V / 15 V, R _G = 2 Ω	t _{d(on)}	–	41.6	–	ns
Rise Time		t _r	–	18	–	
Turn-off Delay Time		t _{d(off)}	–	128	–	
Fall Time		t _f	–	12.8	–	
Turn-on Switching Loss per Pulse		E _{ON}	–	0.63	–	mJ
Turn-off Switching Loss per Pulse		E _{OFF}	–	0.77	–	
Diode Forward Voltage	I _D = 100 A	V _{SD}	–	4.47	6	V
	I _D = 100 A, T _J = 150°C		–	3.92	–	
Thermal Resistance – Chip-to-Case	M1, M2	R _{thJC}	–	0.27	–	°C/W
Thermal Resistance – Chip-to-Heatsink	Thermal grease, Thickness = 2 Mil +2%, A = 2.8 W/mK	R _{thJH}	–	0.49	–	°C/W

SiC DIODE CHARACTERISTICS (D1, D2)

Diode Reverse Leakage Current	V _R = 1200 V	I _R	–	–	400	μA
Diode Forward Voltage	I _F = 100 A, T _J = 25°C	V _F	–	1.54	2.30	V
	I _F = 100 A, T _J = 125°C		–	1.84	–	
	I _F = 100 A, T _J = 150°C		–	1.93	–	
Reverse Recovery Time	T _J = 25°C V _{DS} = 450 V, I _D = 100 A V _{GS} = -5 V / 15 V, R _G = 2 Ω	t _{rr}	–	19.5	–	ns
Reverse Recovery Charge		Q _{rr}	–	439	–	nC
Peak Reverse Recovery Current		I _{RRM}	–	33.4	–	A
Peak Rate of Fall of Recovery Current		di/dt	–	2803	–	A/μs
Reverse Recovery Time	T _J = 150°C V _{DS} = 450 V, I _D = 100 A V _{GS} = -5 V / 15 V, R _G = 2 Ω	t _{rr}	–	20.5	–	ns
Reverse Recovery Charge		Q _{rr}	–	525	–	nC
Peak Reverse Recovery Current		I _{RRM}	–	40.1	–	A
Peak Rate of Fall of Recovery Current		di/dt	–	4002	–	A/μs
Thermal Resistance – Chip-to-Case	D1, D2	R _{thJC}	–	0.26	–	°C/W
Thermal Resistance – Chip-to-Heatsink	Thermal grease, Thickness = 2 Mil +2%, A = 2.8 W/mK	R _{thJH}	–	0.49	–	°C/W

THERMISTOR CHARACTERISTICS

NXH020U90MNF2PTG

ELECTRICAL CHARACTERISTICS (continued)

T_J = 25 °C unless otherwise noted

Parameter	Test Conditions	Symbol	Min	Typ	Max	Unit
Nominal Resistance	T = 25°C	R ₂₅	–	5	–	kΩ
	T = 100°C	R ₁₀₀	–	457	–	Ω
Deviation of R25		ΔR/R	–3	–	3	%
Power Dissipation		P _D	–	50	–	mW
Power Dissipation Constant			–	5	–	mW/K
B-value	B(25/50), tolerance ±3%		–	3375	–	K
B-value	B(25/100), tolerance ±3%		–	3455	–	K

Product parametric performance is indicated in the Electrical Characteristics for the listed test conditions, unless otherwise noted. Product performance may not be indicated by the Electrical Characteristics if operated under different conditions.

ORDERING INFORMATION

Orderable Part Number	Marking	Package	Shipping
NXH020U90MNF2PTG	NXH020U90MNF2PTG	F2-VIENNA: Case 180BZ Press-fit Pins with pre-applied thermal interface material (TIM) (Pb-Free / Halide Free)	20 Units / Blister Tray

NXH020U90MNF2PTG

TYPICAL CHARACTERISTICS

SiC MOSFET (M1/M2)

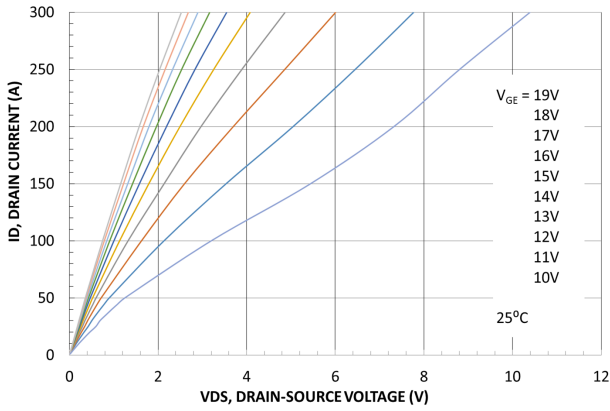

Figure 2. MOSFET Typical Output Characteristic

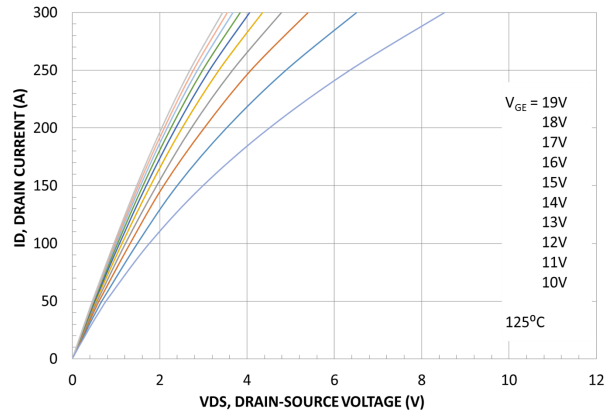

Figure 3. MOSFET Typical Output Characteristic

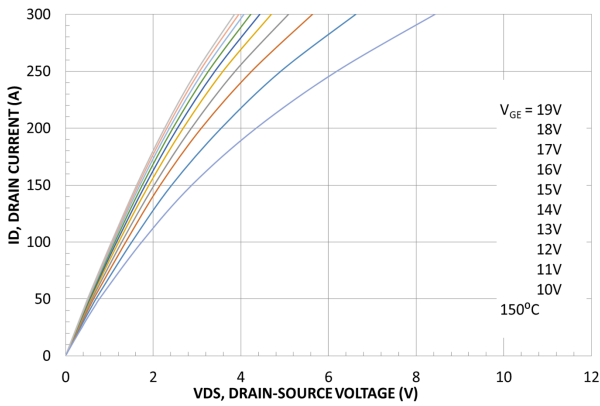

Figure 4. MOSFET Typical Output Characteristic

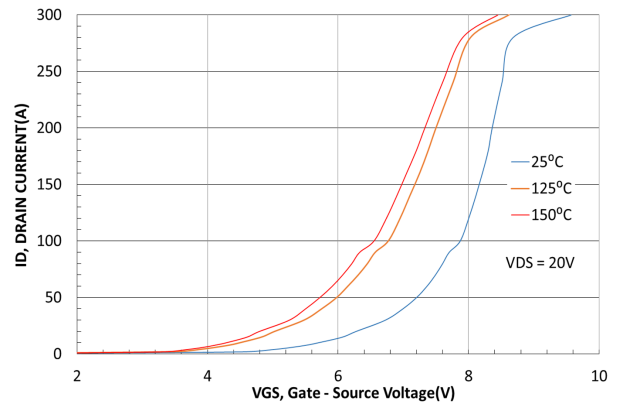

Figure 5. MOSFET Typical Transfer Characteristic

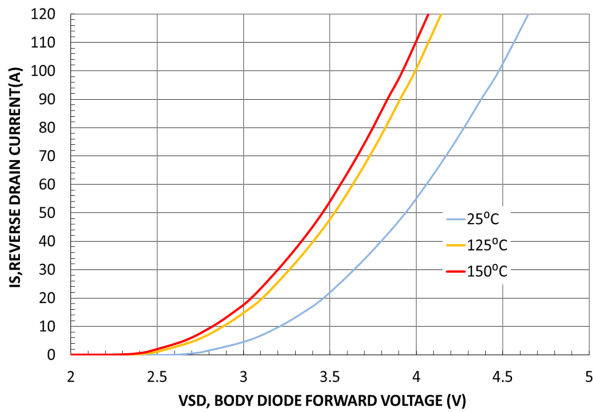

Figure 6. Body Diode Forward Characteristic

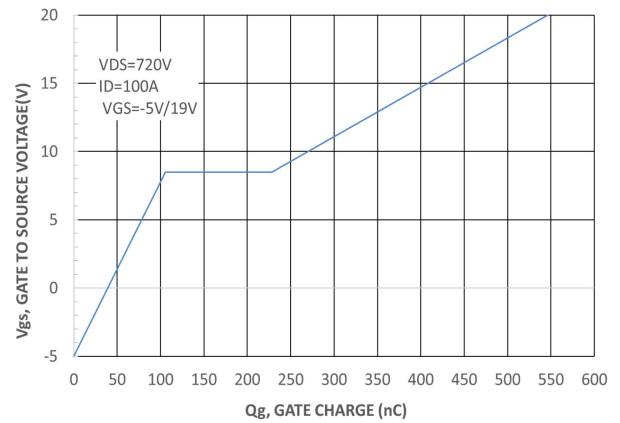

Figure 7. Gate-to-Source Voltage vs. Total Charge

NXH020U90MNF2PTG

TYPICAL CHARACTERISTICS

SiC DIODE (D1/D2)

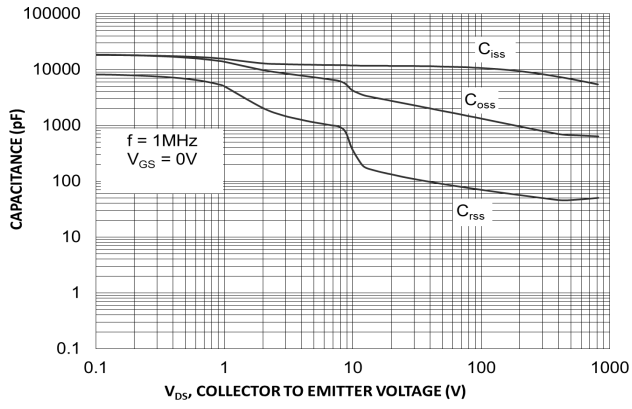

Figure 8. Capacitance vs. Drain-to-Source Voltage

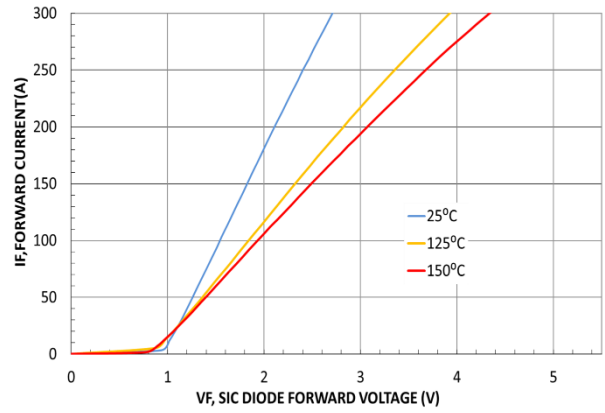

Figure 9. SiC Diode Forward Characteristic

NXH020U90MNF2PTG

TYPICAL CHARACTERISTICS

M1/M2 MOSFET SWITCHING CHARACTERISTICS

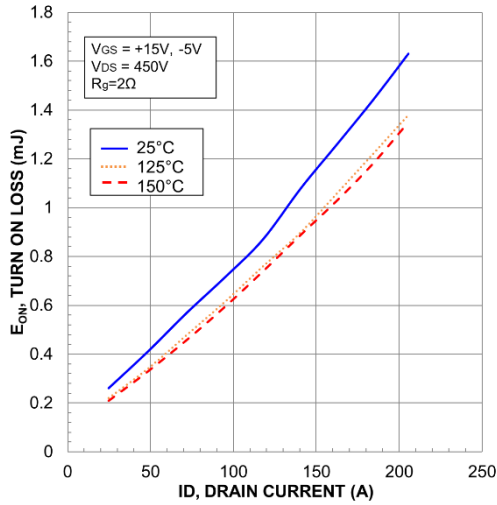

Figure 10. Typical Switching Loss E_{on} vs. I_D

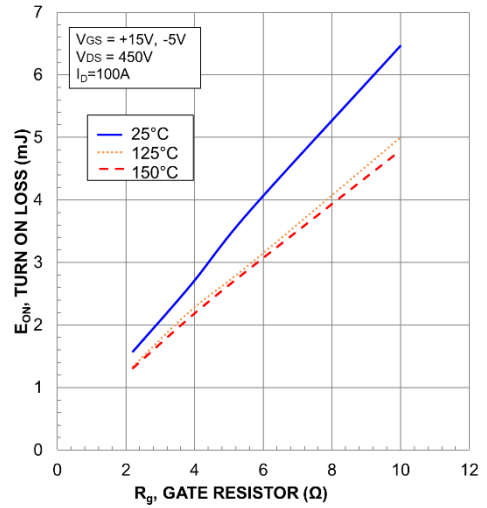

Figure 11. Typical Switching Loss E_{on} vs. R_G

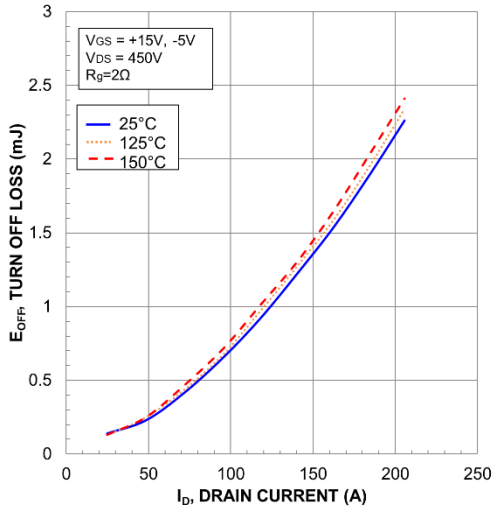

Figure 12. Typical Switching Loss E_{off} vs. I_D

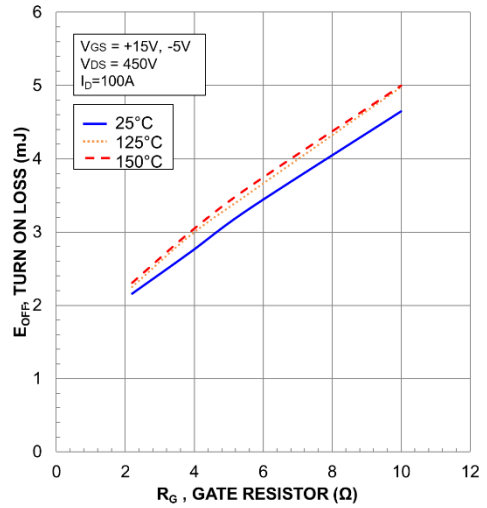

Figure 13. Typical Switching Loss E_{off} vs. R_G

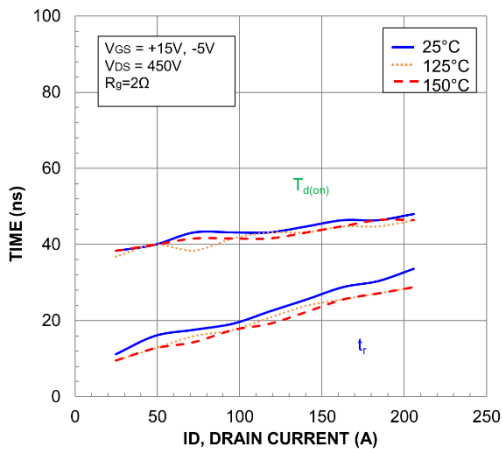

Figure 14. Typical Turn-On Switching $T_{don,tr}$ vs. I_D

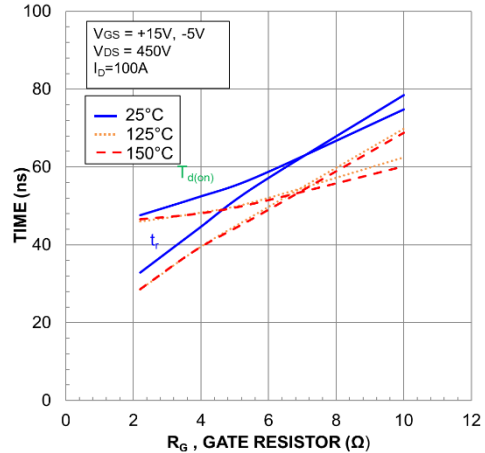

Figure 15. Typical Turn-On Switching $T_{don,tr}$ vs. R_G

NXH020U90MNF2PTG

TYPICAL CHARACTERISTICS

M1/M2 MOSFET SWITCHING CHARACTERISTICS

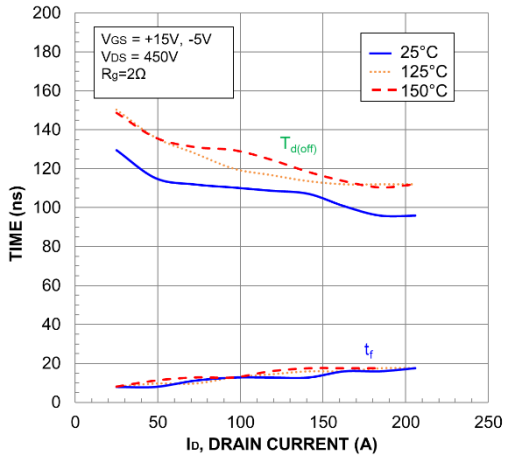

Figure 16. Typical Turn-Off Switching T_{d(off),t_r} vs. ID

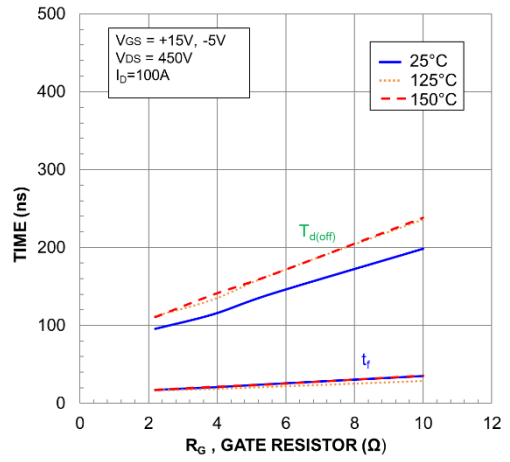

Figure 17. Typical Turn-Off Switching T_{d(off),t_r} vs. R_G

NXH020U90MNF2PTG

TYPICAL CHARACTERISTICS

M1/M2 MOSFET COMMUTATE D1/D2 DIODE

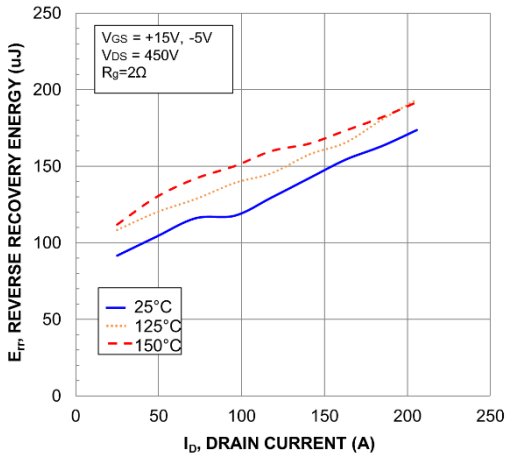

Figure 18. Typical Reverse Recovery Energy vs. ID

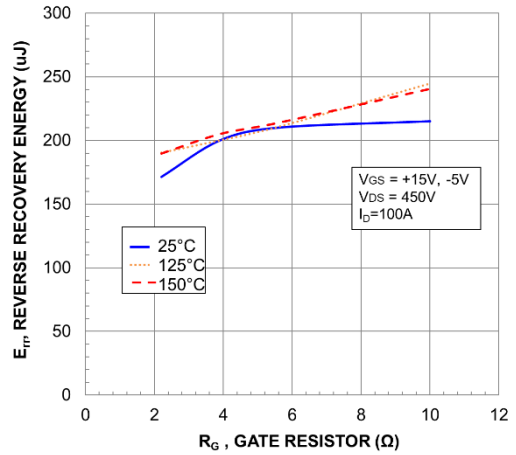

Figure 19. Typical Reverse Recovery Energy vs. R_G

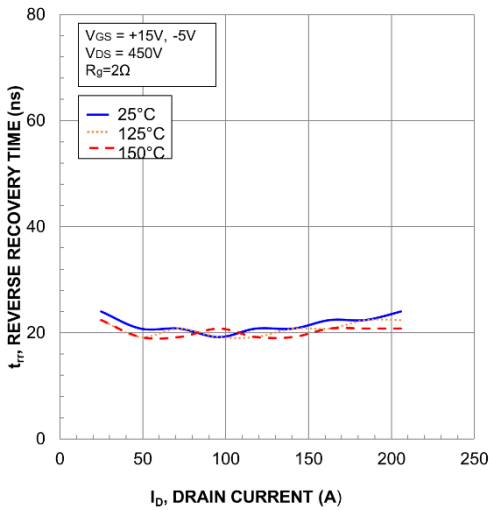

Figure 20. Typical Reverse Recovery Time vs. ID

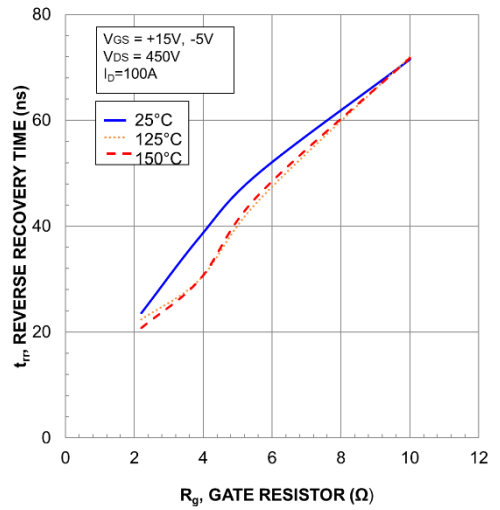

Figure 21. Typical Reverse Recovery Time vs. R_G

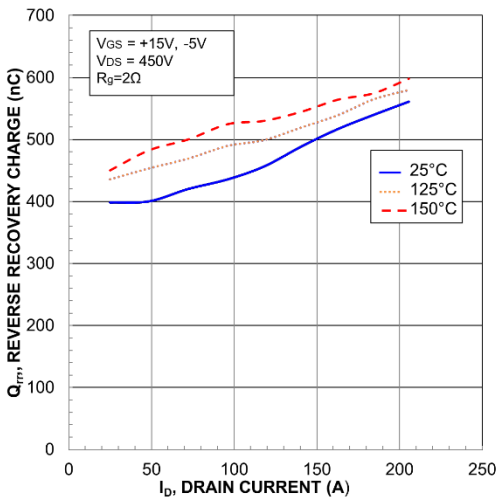

Figure 22. Typical Reverse Recovery Charge vs. ID

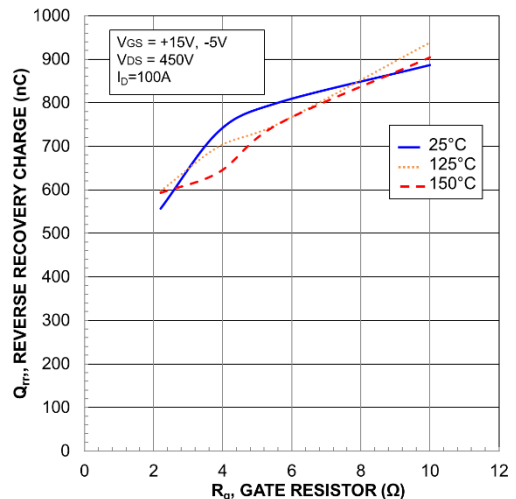

Figure 23. Typical Reverse Recovery Charge vs. R_G

NXH020U90MNF2PTG

TYPICAL CHARACTERISTICS

M1/M2 MOSFET COMMUTATE D1/D2 DIODE

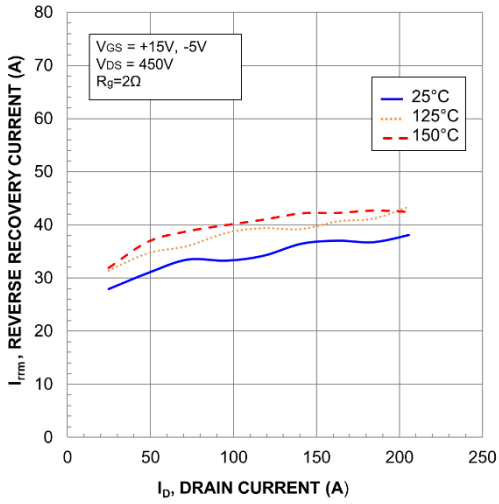

Figure 24. Typical Reverse Recovery Current vs. I_D

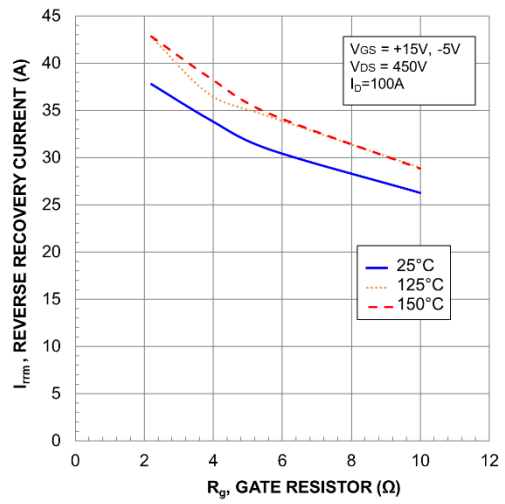

Figure 25. Typical Reverse Recovery Current vs. R_G

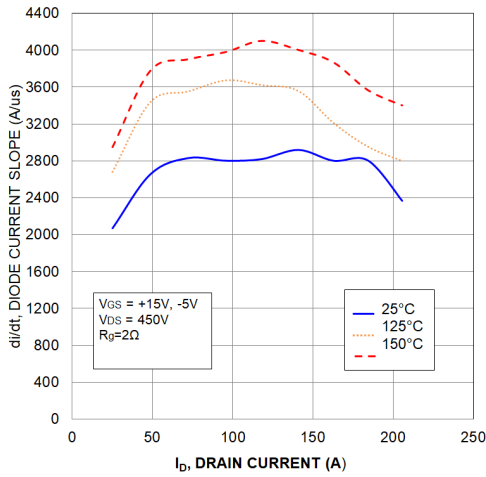

Figure 26. Typical di/dt vs. I_D

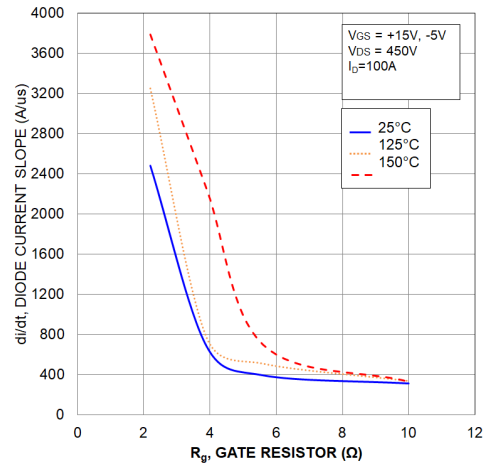

Figure 27. Typical di/dt vs. R_G

NXH020U90MNF2PTG

TYPICAL CHARACTERISTICS M1/M2 MOSFET COMMUTATE D1/D2 DIODE

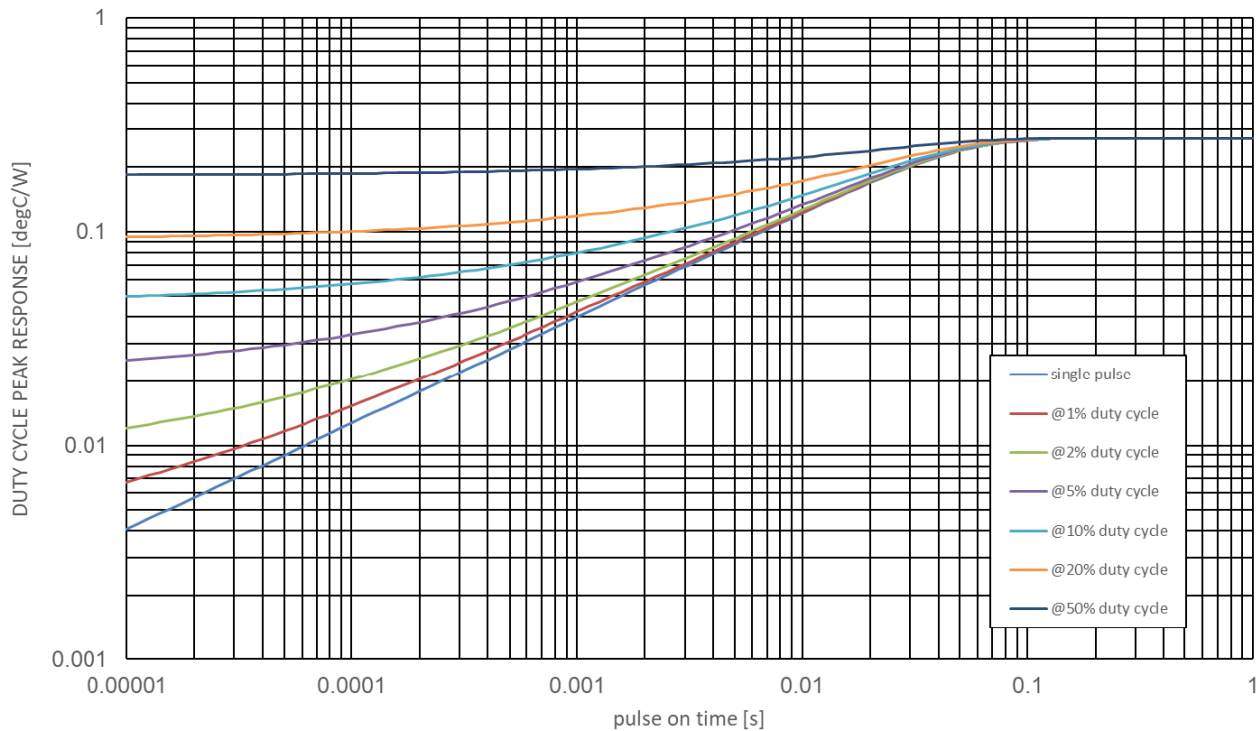

Figure 28. SiC MOSFET Junction-to-Case Transient Thermal Impedance

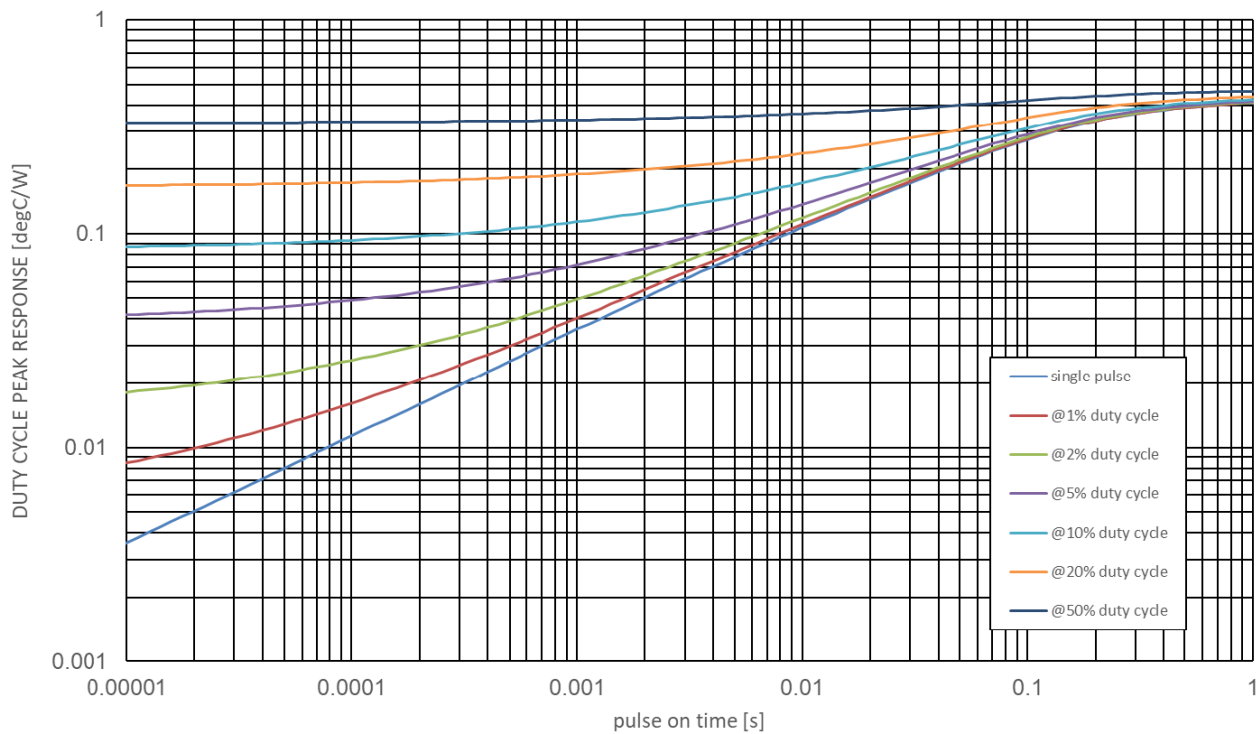

Figure 29. SiC Diode Junction-to-Case Transient Thermal Impedance

MECHANICAL CASE OUTLINE

PACKAGE DIMENSIONS

ON Semiconductor®



PIM20 56.7x42.5 (PRESS FIT) CASE 180BZ ISSUE C

DATE 20 AUG 2021

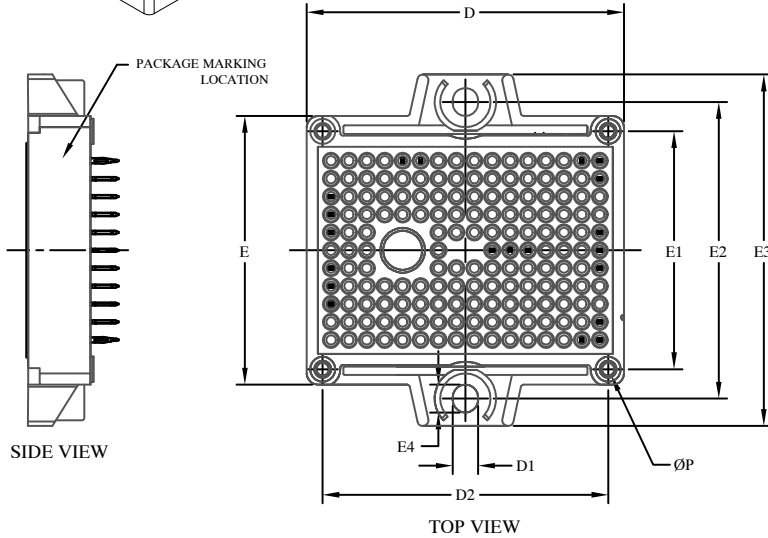
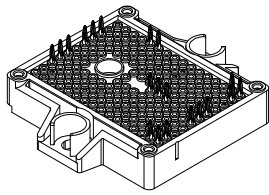

NOTES:

1. CONTROLLING DIMENSION: MILLIMETERS
2. PIN POSITION TOLERANCE IS ± 0.4mm

DIM	MILLIMETERS		
	MIN.	NOM.	MAX.
A	11.65	12.00	12.35
A1	16.00	16.50	17.00
A2	0.00	0.35	0.60
A3	12.85	13.35	13.85
b	1.15	1.20	1.25
b1	0.59	0.64	0.69
D	56.40	56.70	57.00
D1	4.40	4.50	4.60
D2	50.85	51.00	51.15
E	47.70	48.00	48.30
E1	42.35	42.50	42.65
E2	52.90	53.00	53.10
E3	62.30	62.80	63.30
E4	4.90	5.00	5.10
P	2.20	2.30	2.40

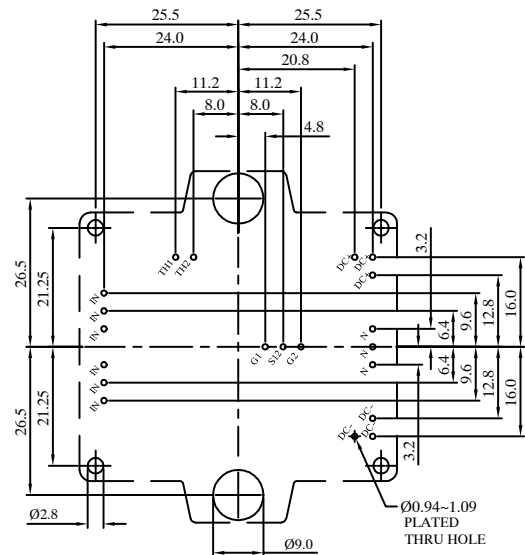
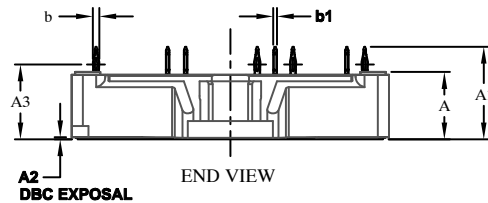

RECOMMENDED MOUNTING PATTERN

GENERIC MARKING DIAGRAM*

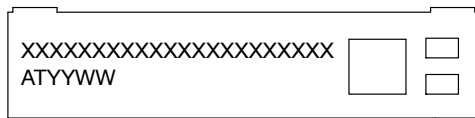

FRONTSIDE MARKING

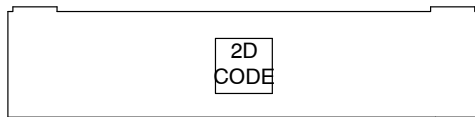

BACKSIDE MARKING

XXXXX = Specific Device Code
AT = Assembly & Test Site Code
YYWW = Year and Work Week Code

*This information is generic. Please refer to device data sheet for actual part marking. Pb-Free indicator, "G" or microdot "•", may or may not be present. Some products may not follow the Generic Marking.

DOCUMENT NUMBER:	98AON19726H	Electronic versions are uncontrolled except when accessed directly from the Document Repository. Printed versions are uncontrolled except when stamped "CONTROLLED COPY" in red.
DESCRIPTION:	PIM20 56.7x42.5 (PRESS FIT)	PAGE 1 OF 1

ON Semiconductor and are trademarks of Semiconductor Components Industries, LLC dba ON Semiconductor or its subsidiaries in the United States and/or other countries. ON Semiconductor reserves the right to make changes without further notice to any products herein. ON Semiconductor makes no warranty, representation or guarantee regarding the suitability of its products for any particular purpose, nor does ON Semiconductor assume any liability arising out of the application or use of any product or circuit, and specifically disclaims any and all liability, including without limitation special, consequential or incidental damages. ON Semiconductor does not convey any license under its patent rights nor the rights of others.

onsemi, **Onsemi**, and other names, marks, and brands are registered and/or common law trademarks of Semiconductor Components Industries, LLC dba "**onsemi**" or its affiliates and/or subsidiaries in the United States and/or other countries. **onsemi** owns the rights to a number of patents, trademarks, copyrights, trade secrets, and other intellectual property. A listing of **onsemi**'s product/patent coverage may be accessed at www.onsemi.com/site/pdf/Patent-Marking.pdf. **onsemi** reserves the right to make changes at any time to any products or information herein, without notice. The information herein is provided "as-is" and **onsemi** makes no warranty, representation or guarantee regarding the accuracy of the information, product features, availability, functionality, or suitability of its products for any particular purpose, nor does **onsemi** assume any liability arising out of the application or use of any product or circuit, and specifically disclaims any and all liability, including without limitation special, consequential or incidental damages. Buyer is responsible for its products and applications using **onsemi** products, including compliance with all laws, regulations and safety requirements or standards, regardless of any support or applications information provided by **onsemi**. "Typical" parameters which may be provided in **onsemi** data sheets and/or specifications can and do vary in different applications and actual performance may vary over time. All operating parameters, including "Typicals" must be validated for each customer application by customer's technical experts. **onsemi** does not convey any license under any of its intellectual property rights nor the rights of others. **onsemi** products are not designed, intended, or authorized for use as a critical component in life support systems or any FDA Class 3 medical devices or medical devices with a same or similar classification in a foreign jurisdiction or any devices intended for implantation in the human body. Should Buyer purchase or use **onsemi** products for any such unintended or unauthorized application, Buyer shall indemnify and hold **onsemi** and its officers, employees, subsidiaries, affiliates, and distributors harmless against all claims, costs, damages, and expenses, and reasonable attorney fees arising out of, directly or indirectly, any claim of personal injury or death associated with such unintended or unauthorized use, even if such claim alleges that **onsemi** was negligent regarding the design or manufacture of the part. **onsemi** is an Equal Opportunity/Affirmative Action Employer. This literature is subject to all applicable copyright laws and is not for resale in any manner.

ADDITIONAL INFORMATION

TECHNICAL PUBLICATIONS:

Technical Library: www.onsemi.com/design/resources/technical-documentation
onsemi Website: www.onsemi.com

ONLINE SUPPORT: www.onsemi.com/support

For additional information, please contact your local Sales Representative at www.onsemi.com/support/sales