

CGH25120F

120 W, 2.3-2.7 GHz, GaN HEMT
for WiMAX and LTE

Description

WolfSpeed's CGH25120F is a gallium nitride (GaN) high electron mobility transistor (HEMT) designed specifically for high efficiency, high gain and wide bandwidth capabilities, which makes the CGH25120F ideal for 2.3-2.7GHz WiMAX, LTE and BWA amplifier applications. The transistor is supplied in a ceramic/metal flange package.

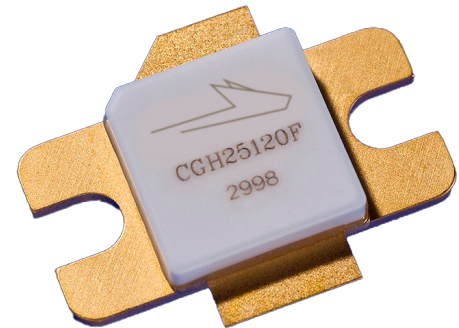

Package Type: 440162
PN: CGH25120F

Typical Performance Over 2.3-2.7GHz ($T_c = 25^\circ\text{C}$) of Demonstration Amplifier

Parameter	2.3 GHz	2.4 GHz	2.5 GHz	2.6 GHz	2.7 GHz	Unit
Gain @ 43 dBm	12.5	12.8	13.1	13.5	13.6	dB
ACLR @ 43 dBm	-32.7	-34.0	-32.5	-29.5	-25.8	dBc
Drain Efficiency @ 43 dBm	26.5	28.0	30.0	32.5	34.5	%

Notes:

¹ Measured in the CGH25120F-AMP amplifier circuit, under equivalent 802.16e WiMAX signal, 10 MHz Bandwidth, PAR = 9.6 dB @ 0.01 % Probability on CCDF.

Features

- 2.3 - 2.7 GHz Operation
- 13 dB Gain
- -32 dBc ACLR at 20 W P_{AVE}
- 30% Efficiency at 20 W P_{AVE}
- High Degree of DPD Correction Can be Applied







Absolute Maximum Ratings (not simultaneous) at 25°C Case Temperature

Parameter	Symbol	Rating	Units	Conditions
Drain-Source Voltage	V_{DSS}	120	V	25°C
Gate-to-Source Voltage	V_{GS}	-10, +2		
Power Dissipation	P_{DISS}	56	W	
Storage Temperature	T_{STG}	-65, +150	°C	
Operating Junction Temperature	T_J	225		
Maximum Forward Gate Current	I_{GMAX}	30	mA	25°C
Maximum Drain Current ¹	I_{DMAX}	12		
Soldering Temperature ²	T_S	245	°C	
Screw Torque	τ	40	in-oz	
Thermal Resistance, Junction to Case ³	$R_{\theta JC}$	1.5	°C/W	85°C
Case Operating Temperature ³	T_C	-40, +150	°C	

Notes:

¹ Current limit for long term, reliable operation

² Refer to the Application Note on soldering at wolfspeed.com/rf/document-library

³ Measured for the CGH25120F at $P_{DISS} = 56$ W

Electrical Characteristics ($T_C = 25^\circ\text{C}$)

Characteristics	Symbol	Min.	Typ.	Max.	Units	Conditions
DC Characteristics¹						
Gate Threshold Voltage	$V_{GS(th)}$	-3.8	-3.0	-2.3	V_{DC}	$V_{DS} = 10$ V, $I_D = 28.8$ mA
Gate Quiescent Voltage	$V_{GS(Q)}$	—	-2.7	—		$V_{DS} = 28$ V, $I_D = 0.5$ A
Saturated Drain Current ²	I_{DS}	23.2	28.0	—	A	$V_{DS} = 6.0$ V, $V_{GS} = 2.0$ V
Drain-Source Breakdown Voltage	V_{BR}	84	—	—	V_{DC}	$V_{GS} = -8$ V, $I_D = 28.8$ mA
RF Characteristics ($T_C = 25^\circ\text{C}$, $F_0 = 2.5$ GHz unless otherwise noted)						
Saturated Output Power ^{3, 4, 5}	P_{SAT}	—	130	—	W	$V_{DD} = 28$ V, $I_{DQ} = 0.5$ A
Pulsed Drain Efficiency ^{3, 5}	η	—	60	—	%	$V_{DD} = 28$ V, $I_{DQ} = 0.5$ A, $P_{OUT} = P_{SAT}$
Modulated Gain ⁶	G	10.5	12.5	—	dB	$V_{DD} = 28$ V, $I_{DQ} = 0.5$ A, $P_{OUT} = 43$ dBm
WCDMA Linearity ^{6, 7}	ACLR	—	-31	-27	dBc	
Modulated Drain Efficiency ⁶	η	27	32	—	%	
Output Mismatch Stress	VSWR	—	—	10 : 1	Ψ	No damage at all phase angles, $V_{DD} = 28$ V, $I_{DQ} = 1.0$ A, $P_{OUT} = 20$ W CW
Dynamic Characteristics						
Input Capacitance ⁸	C_{GS}	—	88	—	pF	$V_{DS} = 28$ V, $V_{GS} = -8$ V, $f = 1$ MHz
Output Capacitance ⁸	C_{DS}	—	12	—		
Feedback Capacitance	C_{GD}	—	1.6	—		

Notes:

¹ Measured on wafer prior to packaging

² Scaled from PCM data

³ Pulse Width = 40 μ s, Duty Cycle = 5%

⁴ P_{SAT} is defined as $I_G = 10$ mA peak

⁵ Measured in CGH25120F-AMP

⁶ Equivalent 802.16e WiMAX signal, 10 MHz Bandwidth, PAR = 9.6 dB @ 0.01% Probability on CCDF

⁷ Measured over 10 MHz bandwidth at 10 MHz offset from carrier edge.

⁸ Includes package and internal matching components.



Typical Performance

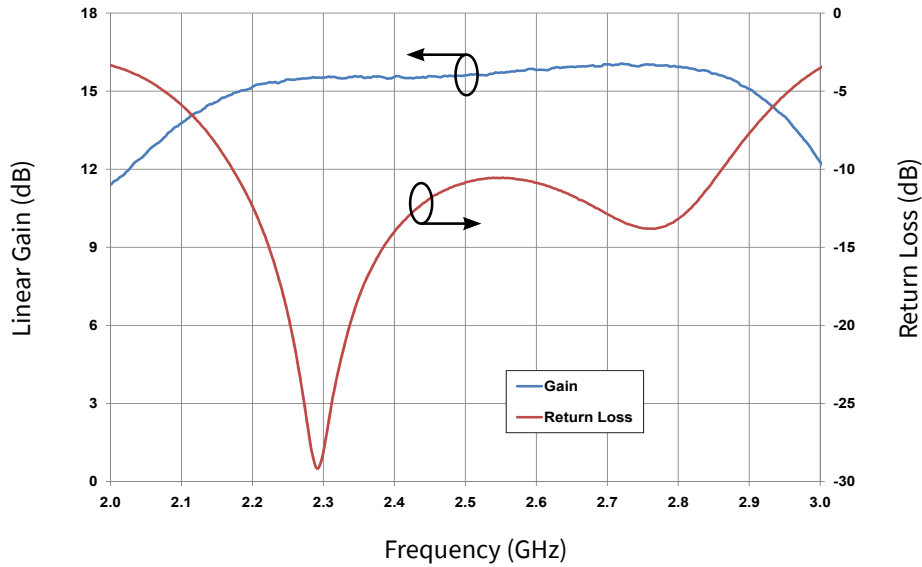

Figure 1. Gain and Input Return Loss vs Frequency of CGH25120F in Broadband Amplifier Circuit
 $V_{DD} = 28\text{ V}$, $I_{DQ} = 0.5\text{ A}$

Typical Mobile WiMAX Digital Pre-Distortion (DPD) Performance

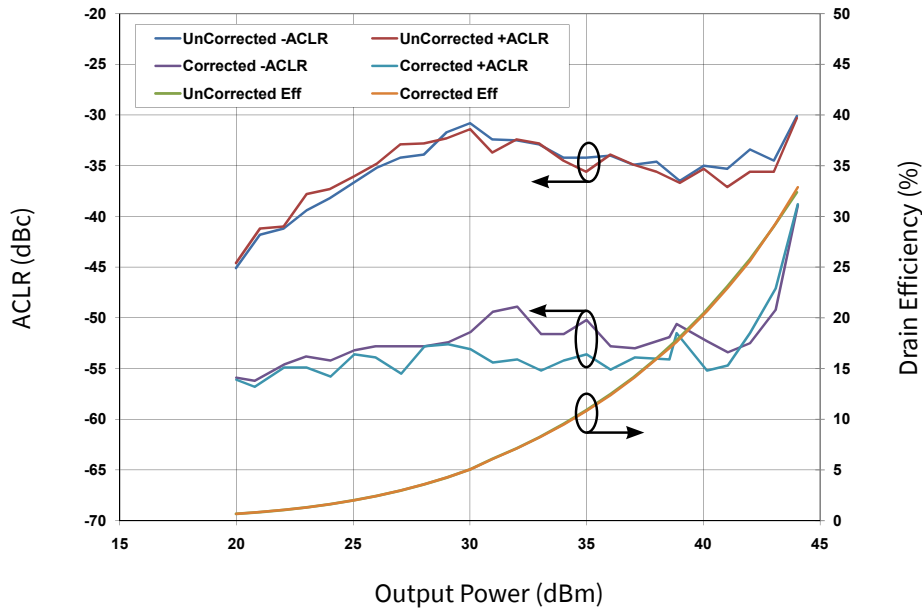

Figure 2. WiMAX Characteristics with and without DPD Correction ACLR and Drain Efficiency vs Output Power measured in CGH25120F-AMP Amplifier Circuit
 $V_{DS} = 28\text{ V}$, $I_{DS} = 0.5\text{ A}$, Frequency = 2.5 GHz



Typical Performance

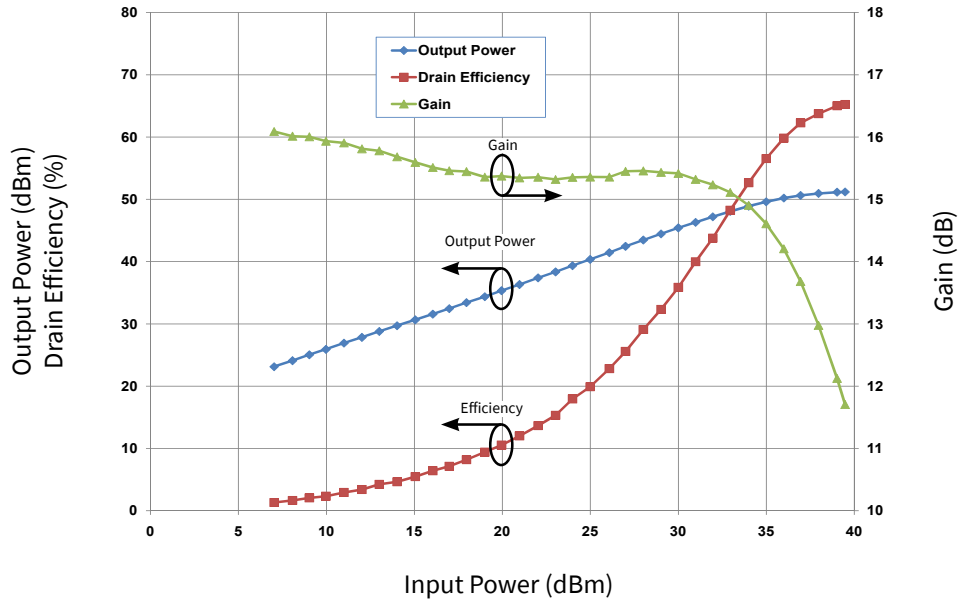

Figure 3. Typical Pulse Characteristics Output Power, Drain Efficiency, and Gain vs Input Power measured in CGH25120F-AMP Amplifier Circuit
 $V_{DD} = 28\text{ V}$, $I_{DS} = 0.5\text{ A}$, Freq = 2.5 GHz, Pulse Width = 40 μs , Duty Cycle = 5%

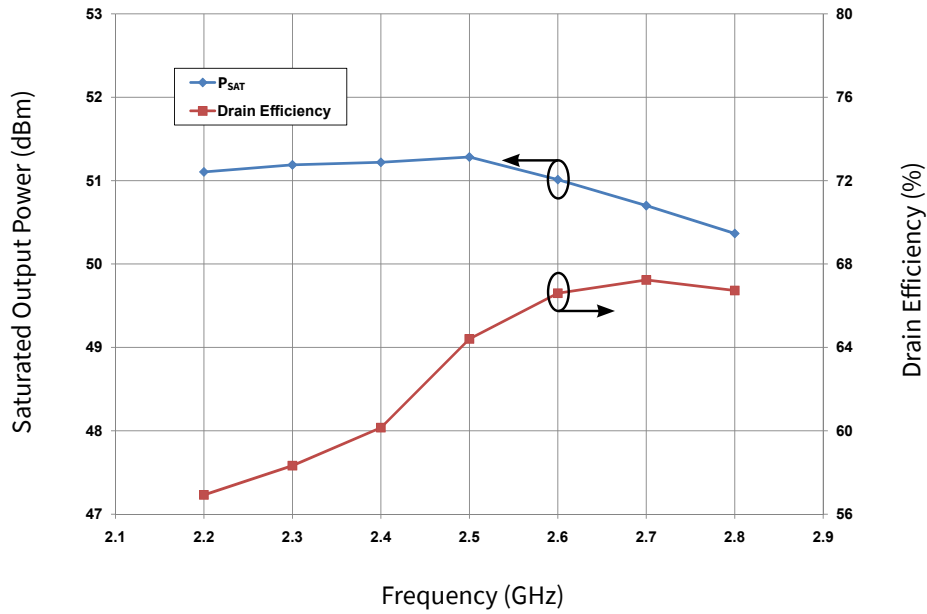

Figure 4. Typical Pulsed Saturated Power vs Frequency measured in CGH25120F-AMP Amplifier Circuit
 $V_{DS} = 28\text{ V}$, $I_{DS} = 0.5\text{ A}$, $P_{SAT} = 10\text{ mA}$ I_{GS} Peak, Pulse Width = 40 μs , Duty Cycle = 5%



Typical Performance

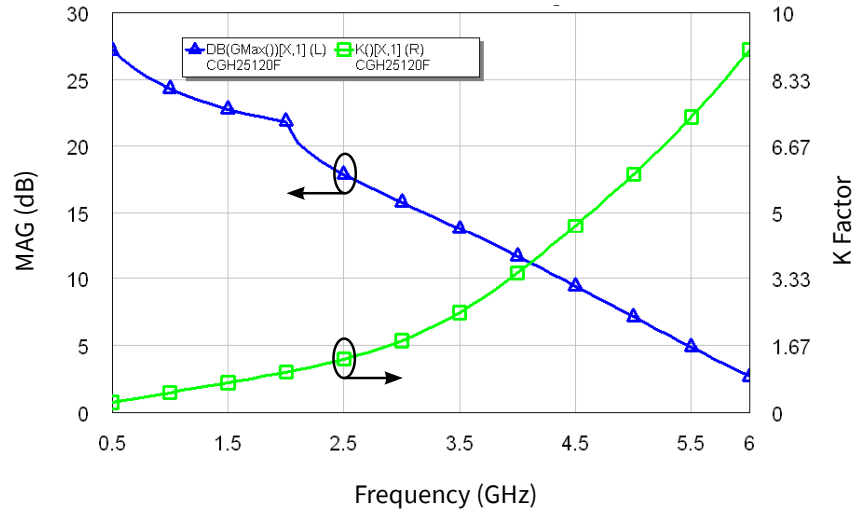

Figure 5. Simulated Maximum Available Gain and K Factor of the CGH25120F
 $V_{DD} = 28\text{ V}$, $I_{DQ} = 500\text{ mA}$

Typical Noise Performance

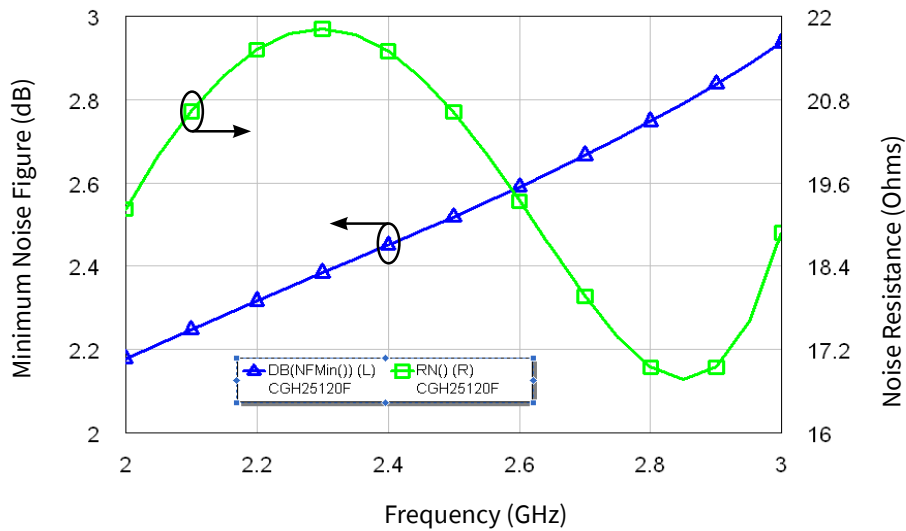
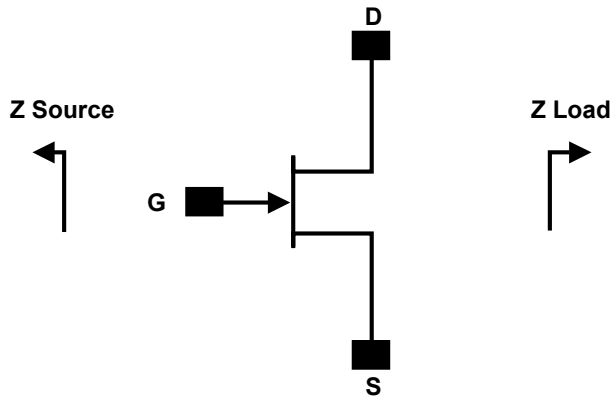

Figure 6. Simulated Minimum Noise Figure and Noise Resistance vs Frequency of the CGH25120F
 $V_{DD} = 28\text{ V}$, $I_{DQ} = 500\text{ mA}$

Electrostatic Discharge (ESD) Classifications

Parameter	Symbol	Class	Classification Level	Test Methodology
Human Body Model	HBM	TBD	ANSI/ESDA/JEDEC JS-001 Table 3	JEDEC JESD22 A114-D
Charge Device Model	CDM	TBD	ANSI/ESDA/JEDEC JS-002 Table 3	JEDEC JESD22 C101-C

Source and Load Impedances



Frequency (MHz)	Z Source	Z Load
2300	6.80 - j12.19	4.38 - j1.42
2350	6.42 - j11.89	4.39 - j1.36
2400	6.05 - j11.61	4.39 - j1.33
2450	15.71 - j11.34	4.36 - j1.32
2500	5.37 - j11.08	4.31 - j1.33
2550	5.04 - j10.83	4.23 - j1.34
2600	4.71 - j10.57	4.11 - j1.36
2650	4.39 - j10.31	3.98 - j1.37
2700	4.07 - j10.04	3.80 - j1.36

Notes:

¹ $V_{DD} = 28\text{ V}$, $I_{DQ} = 500\text{ mA}$. In the 440162 package

² Impedances are extracted from CGH25120F-AMP demonstration circuit and are not source and load pull data derived from transistor

CGH25120F Power Dissipation De-rating Curve

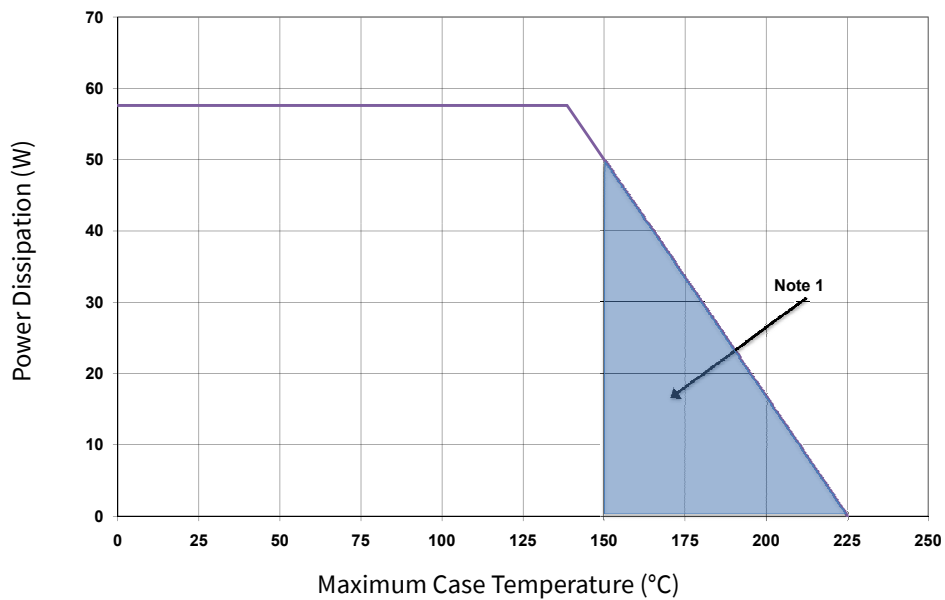

Note:

¹ Area exceeds Maximum Case Operating Temperature (See Page 2)



CGH25120F-AMP Demonstration Amplifier Circuit Bill of Materials

Designator	Description	Qty
R1	RES, 1/16 W, 0603, 1%, 150 OHMS	1
R2	RES, 1/16 W, 0603, 1%, 5.1 OHMS	1
C1	CAP, 6.8pF, +/-0.25pF, 0603, ATC600S	1
C2	CAP, 27pF, +/-5%, 0603, ATC600S	1
C3, C9, C15	CAP, 8.2pF, +/-0.25pF, 0603, ATC600S	3
C4, C10	CAP, 82.0pF, +/-5%, 0603, ATC600S	2
C5, C11	CAP, 470pF, 5%, 100V, 0603, X7R	2
C6, C12, C16	CAP, 33000pF, 0805, 100V, X7R	3
C7	CAP, 10μF, 16V, TANTALUM	1
C8	CAP, 24pF, +/-5%, 0603, ATC600S	1
C13, C17	CAP, 1.0μF, 100V, 10%, X7R, 1210	2
C14	CAP, 100μF, +/-20%, 160V, ELECTROLYTIC	1
J1, J2	CONN, N-Type, Female, 0.500 SMA Flange	2
J3	CONN, Header, RT> PLZ, 0.1 CEN, LK, 9 POS	1
—	PCB, RO4350, Er = 3.48, h = 20 mil	1
—	CGH25120F	1

CGH25120F-AMP Demonstration Amplifier Circuit

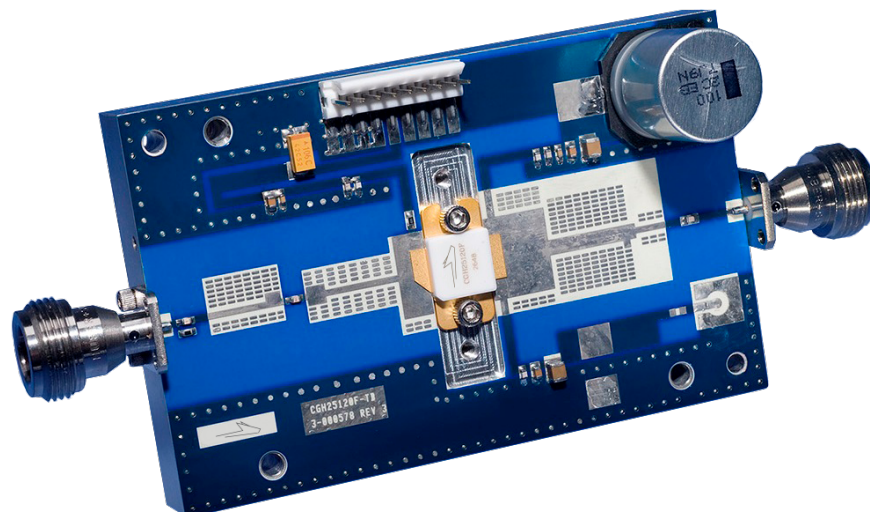



CGH25120F-AMP Demonstration Amplifier Circuit Schematic

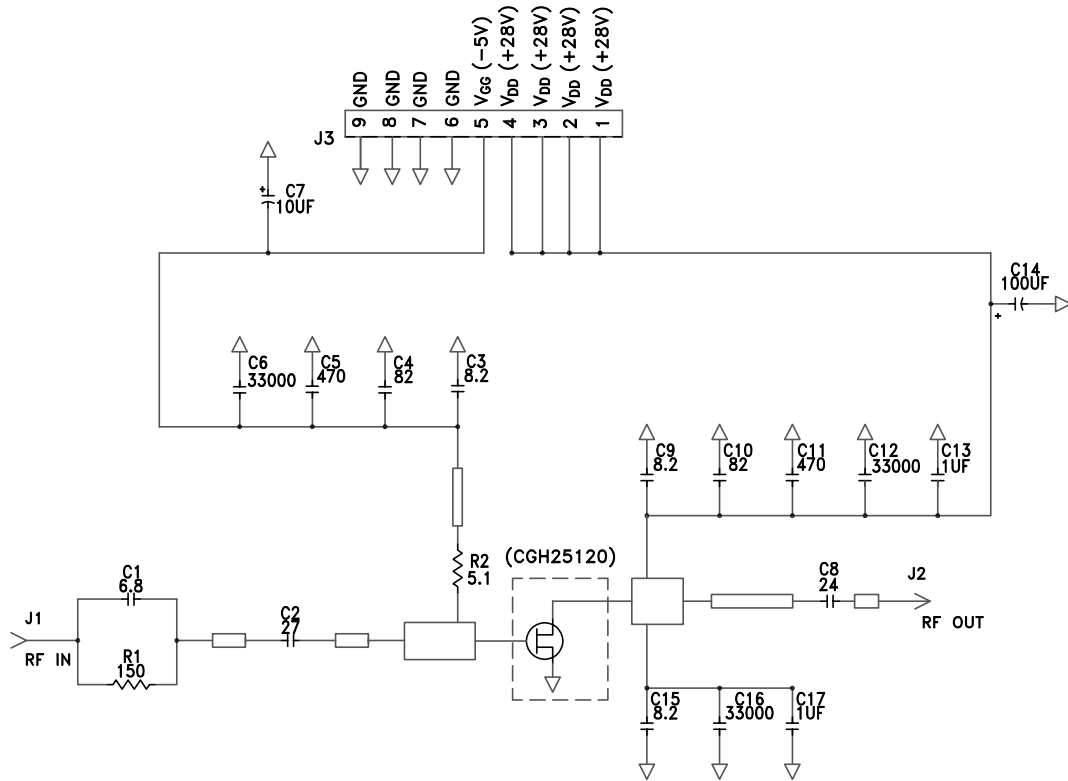

CGH25120F-AMP Demonstration Amplifier Circuit Outline

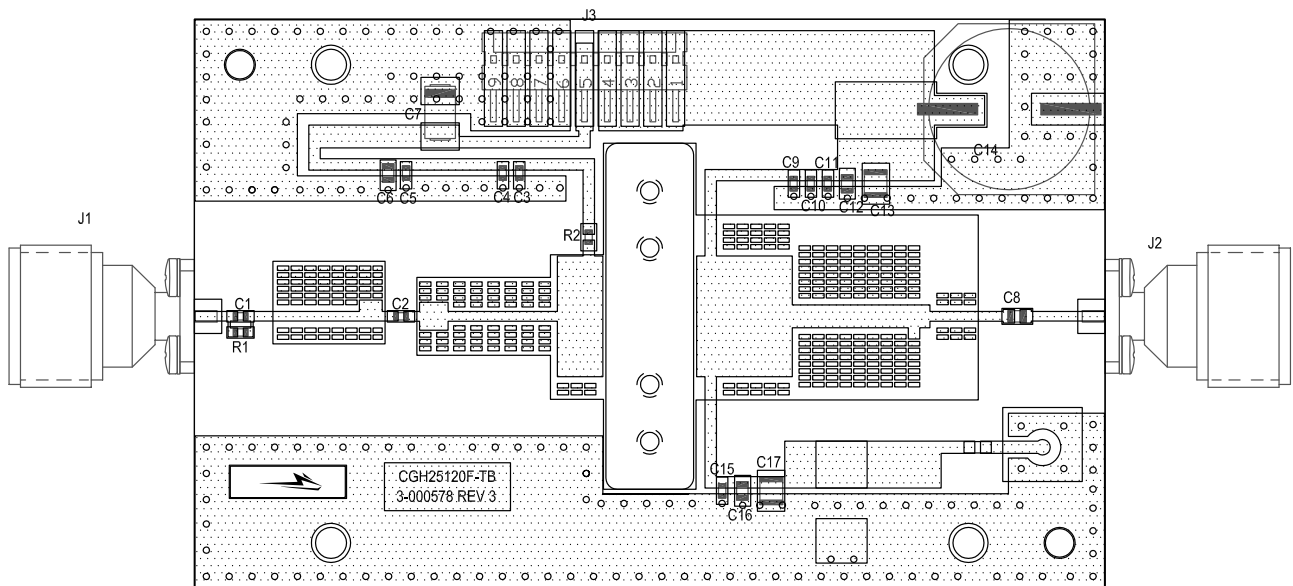



Typical Package S-Parameters for CGH25120
 (Small Signal, $V_{DS} = 28\text{ V}$, $I_{DQ} = 500\text{ mA}$, angle in degrees)

Frequency	Mag S11	Ang S11	Mag S21	Ang S21	Mag S12	Ang S12	Mag S22	Ang S22
500 MHz	0.970	179.55	3.23	65.19	0.006	-19.55	0.697	-171.85
600 MHz	0.969	178.04	2.71	59.73	0.006	-23.92	0.712	-171.11
700 MHz	0.969	176.68	2.35	54.43	0.006	-28.13	0.728	-170.54
800 MHz	0.968	175.39	2.08	49.24	0.006	-32.20	0.744	-170.15
900 MHz	0.967	174.12	1.88	44.13	0.006	-36.17	0.760	-169.90
1.0 GHz	0.965	172.86	1.73	39.07	0.006	-40.07	0.776	-169.80
1.1 GHz	0.963	171.57	1.62	34.02	0.007	-43.93	0.792	-169.82
1.2 GHz	0.961	170.24	1.53	28.94	0.007	-47.79	0.808	-169.93
1.3 GHz	0.957	168.86	1.47	23.78	0.007	-51.71	0.823	-170.13
1.4 GHz	0.953	167.39	1.43	18.47	0.007	-55.72	0.838	-170.41
1.5 GHz	0.948	165.84	1.41	12.95	0.007	-59.92	0.853	-170.74
1.6 GHz	0.941	164.19	1.40	7.11	0.008	-64.38	0.868	-171.14
1.7 GHz	0.932	162.42	1.41	0.85	0.008	-69.21	0.882	-171.61
1.8 GHz	0.921	160.54	1.44	-5.98	0.009	-74.56	0.897	-172.16
1.9 GHz	0.906	158.55	1.49	-13.54	0.009	-80.57	0.912	-172.82
2.0 GHz	0.887	156.51	1.54	-22.02	0.010	-87.43	0.928	-173.62
2.1 GHz	0.863	154.51	1.61	-31.62	0.011	-95.34	0.943	-174.61
2.2 GHz	0.836	152.72	1.68	-42.48	0.012	-104.43	0.956	-175.83
2.3 GHz	0.807	151.32	1.73	-54.61	0.012	-114.71	0.966	-177.27
2.4 GHz	0.782	150.41	1.76	-67.78	0.013	-125.92	0.970	-178.85
2.5 GHz	0.767	149.70	1.74	-81.50	0.013	-137.58	0.968	179.58
2.6 GHz	0.765	148.57	1.69	-95.15	0.013	-149.05	0.960	178.22
2.7 GHz	0.772	146.34	1.61	-108.22	0.012	-159.82	0.948	177.17
2.8 GHz	0.784	142.57	1.52	-120.49	0.012	-169.67	0.937	176.41
2.9 GHz	0.795	137.00	1.43	-132.07	0.012	-178.68	0.926	175.88
3.0 GHz	0.802	129.35	1.37	-143.26	0.011	172.84	0.918	175.48
3.2 GHz	0.800	105.38	1.29	-166.46	0.011	155.52	0.907	174.80
3.4 GHz	0.786	62.35	1.25	164.88	0.011	133.38	0.901	174.02
3.6 GHz	0.824	-2.68	1.08	128.15	0.010	103.76	0.897	172.96
3.8 GHz	0.913	-61.31	0.73	93.46	0.007	76.68	0.890	171.72
4.0 GHz	0.963	-96.70	0.45	69.63	0.005	60.78	0.881	170.41
4.2 GHz	0.983	-116.99	0.29	53.87	0.003	53.02	0.872	168.93
4.4 GHz	0.992	-129.53	0.19	42.45	0.002	49.41	0.860	167.19
4.6 GHz	0.995	-137.94	0.14	33.27	0.002	47.62	0.844	165.11
4.8 GHz	0.997	-143.97	0.10	25.19	0.002	46.36	0.823	162.61
5.0 GHz	0.998	-148.50	0.08	17.50	0.001	44.82	0.793	159.54
5.2 GHz	0.999	-152.04	0.07	9.61	0.001	42.41	0.751	155.74
5.4 GHz	0.999	-154.90	0.06	0.93	0.001	38.57	0.688	150.96
5.6 GHz	0.999	-157.26	0.05	-9.20	0.001	32.67	0.594	145.02
5.8 GHz	0.999	-159.26	0.04	-21.62	0.001	23.98	0.453	138.33
6.0 GHz	1.000	-160.97	0.04	-36.99	0.001	11.87	0.251	136.18

To download the s-parameters in s2p format, go to the [CGH25120F Product page](#) and click on the documentation tab.



Product Dimensions CGH25120F (Package Type — 440162)

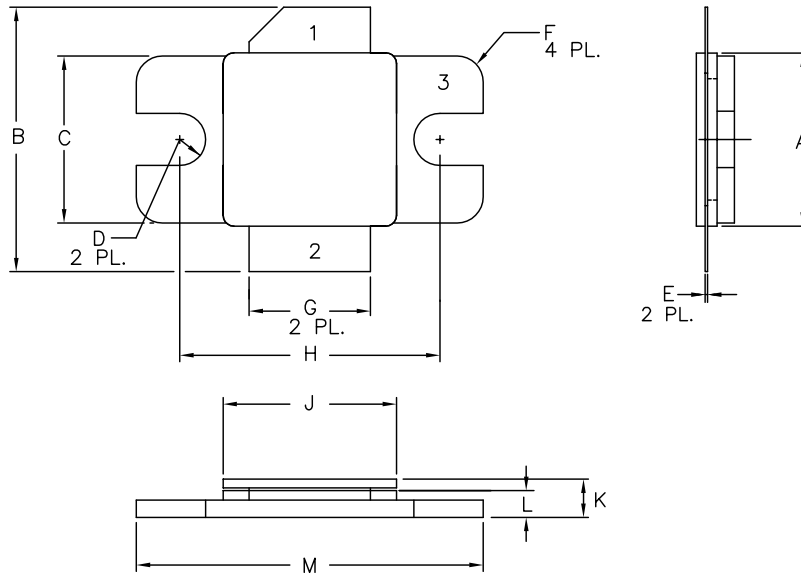

NOTES:

1. DIMENSIONING AND TOLERANCING PER ANSI Y14.5M, 1982.
2. CONTROLLING DIMENSION: INCH.
3. ADHESIVE FROM LID MAY EXTEND A MAXIMUM OF 0.020" BEYOND EDGE OF LID.
4. LID MAY BE MISALIGNED TO THE BODY OF THE PACKAGE BY A MAXIMUM OF 0.008" IN ANY DIRECTION.

DIM	INCHES		MILLIMETERS	
	MIN	MAX	MIN	MAX
A	.395	.405	10.03	10.29
B	.580	.620	14.73	15.75
C	.380	.390	9.65	9.91
D	.055	.065	1.40	1.65
E	.004	.006	0.10	0.15
F	.055	.065	1.40	1.65
G	.275	.285	6.99	7.24
H	.595	.605	15.11	15.37
J	.395	.405	10.03	10.29
K	.129	.149	3.28	3.78
L	.053	.067	1.35	1.70
M	.795	.805	20.19	20.45

- PIN 1. GATE
 PIN 2. DRAIN
 PIN 3. SOURCE

Product Ordering Information

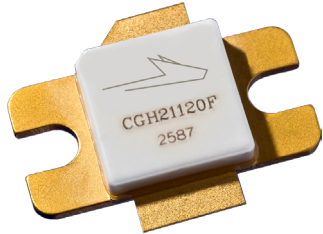
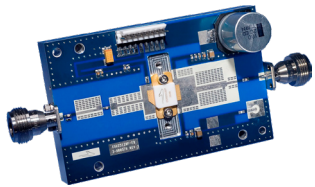
Order Number	Description	Unit of Measure	Image
CGH25120F	GaN HEMT	Each	
CGH25120F-AMP	Test board with GaN HEMT installed	Each	

**For more information, please contact:**

4600 Silicon Drive
Durham, NC 27703 USA
Tel: +1.919.313.5300
www.wolfspeed.com/RF

Sales Contact
RFSales@wolfspeed.com

RF Product Marketing Contact
RFMarketing@wolfspeed.com

Notes & Disclaimer

Specifications are subject to change without notice. “Typical” parameters are the average values expected by Wolfspeed in large quantities and are provided for information purposes only. Wolfspeed products are not warranted or authorized for use as critical components in medical, life-saving, or life-sustaining applications, or other applications where a failure would reasonably be expected to cause severe personal injury or death. No responsibility is assumed by Wolfspeed for any infringement of patents or other rights of third parties which may result from use of the information contained herein. No license is granted by implication or otherwise under any patent or patent rights of Wolfspeed.

© 2015-2022 Wolfspeed, Inc. All rights reserved. Wolfspeed® and the Wolfstreak logo are registered trademarks and the Wolfspeed logo is a trademark of Wolfspeed, Inc.
PATENT: <https://www.wolfspeed.com/legal/patents>

The information in this document is subject to change without notice.