

SF2353E

**1582.4 MHz
SAW Filter**

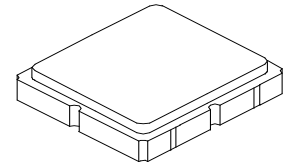

SM3030-6

- **Filter, 1582.4 MHz**
- **3.0 x 3.0 x 1.4 mm Surface-Mount Case**
- **Complies with Directive 2002/95/EC (RoHS)**
- **Moisture Sensitivity Level: 1**
- **AEC-Q200 Qualified**

Absolute Maximum Rating	Value	Units
Input Power Level	15	dBm
DC Voltage	3	V
Operable Temperature Range	-40 to +125	°C
Operating Temperature Range	-40 to +85	°C
Storage Temperature Range in Tape and Reel	-40 to +85	°C

Electrical Characteristics

Characteristic	Sym	Notes	Min	Typ	Max	Units
Center Frequency	f_c			1582.4		MHz
Insertion Loss	IL(min)					dB
1574.42 to 1576.42 MHz				1.2	2.0	
1559.05 to 1563.15 MHz				1.7	2.2	
1573.37 to 1577.47 MHz				1.3	2.0	
1597.78 to 1605.66 MHz				1.5	2.0	
GD Ripple (1597.55 to 1605.89 MHz)				5	12	ns
VSWR						-
1574.42 to 1576.42 MHz				1.6	2.0	
1559.05 to 1563.15 MHz				1.3	2.0	
1573.37 to 1577.47 MHz				1.7	2.0	
1597.78 to 1605.66 MHz				1.4	2.0	
Attenuation (relative to ILmin)						dB
10 to 824 MHz			30	38		
824 to 925 MHz			30	37		
1427 to 1453 MHz			40	47		
1625 MHz			25	42		
1710 to 1785 MHz			37	45		
1850 to 1910 MHz			38	47		
1920 to 1980 MHz			39	49		
2400 to 2500 MHz			35	45		
2500 to 2570 MHz			37	45		
2600 to 3000 MHz			20	41		

Case Style	SM3030-6 3.0 x 3.0 x 1.4 mm Nominal Footprint		
Lid Symbolization, Y=year, WW=week, S=shift	B20, YWWS		
Standard Reel Quantity	Reel Size 7 Inch	500 Pieces/Reel	
	Reel Size 13 Inch	3000 Pieces/Reel	



CAUTION: Electrostatic Sensitive Device. Observe precautions for handling.

NOTES:

1. The design, manufacturing process, and specifications of this device are subject to change.
2. US or International patents may apply.
3. RoHS compliant from the first date of manufacture.

Measurement Circuit - Electrical Connections

Connection	Terminals
Input	2
Output	5
Ground	1, 3, 4, 6
Dot indicates Pin 1	

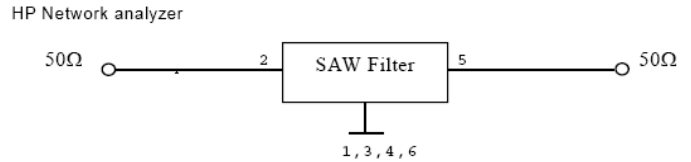

Frequency Characteristics:

S21 Response: (span 100 MHz)

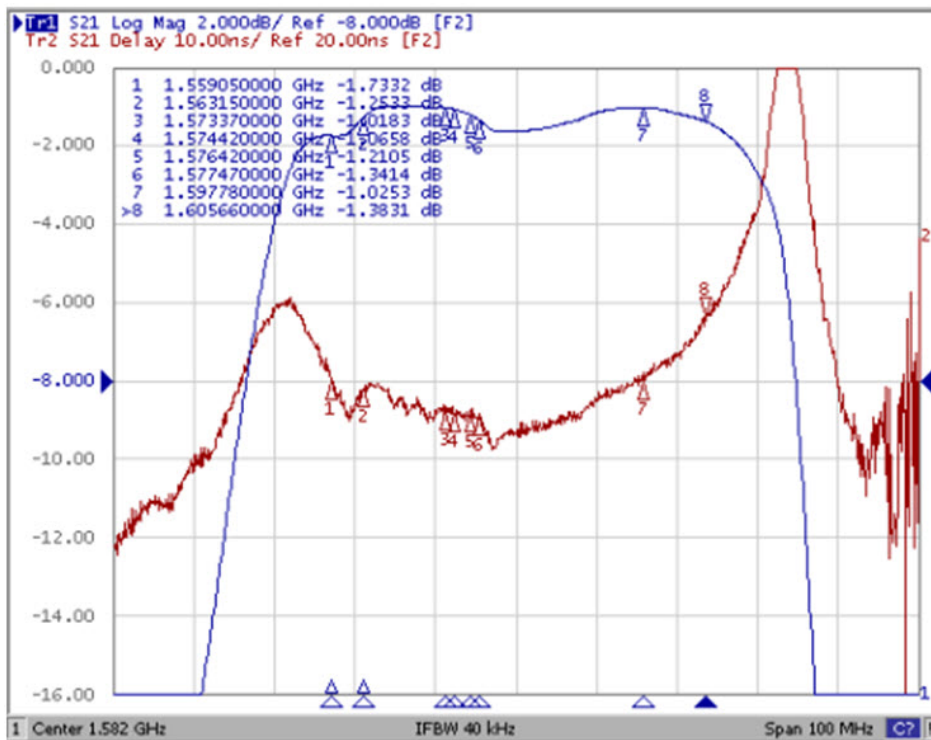

S21 Response: (span 300 MHz)

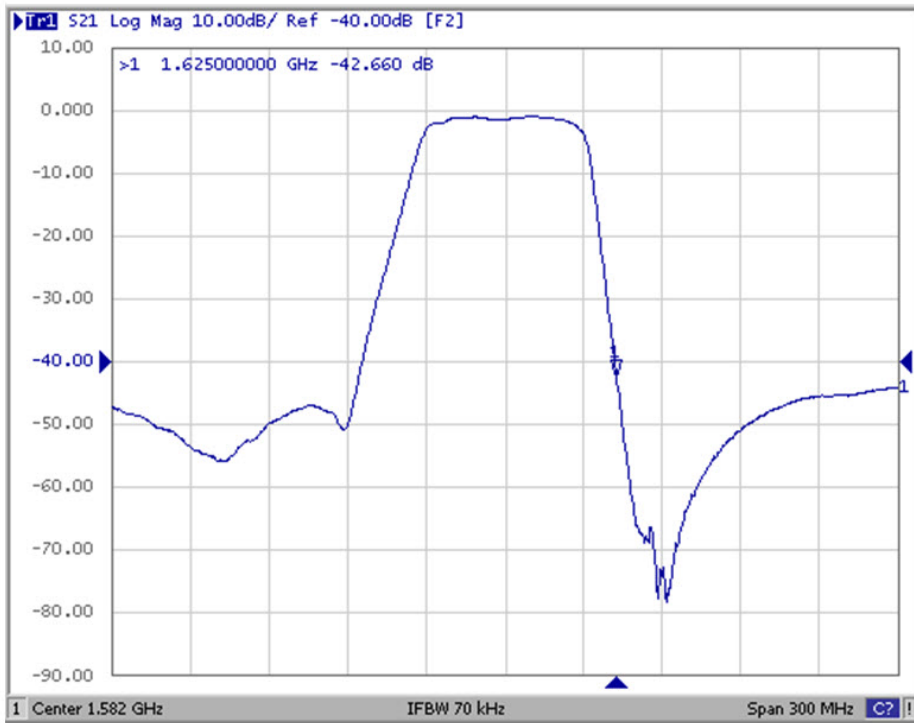

S21 Response: (span 500 MHz)

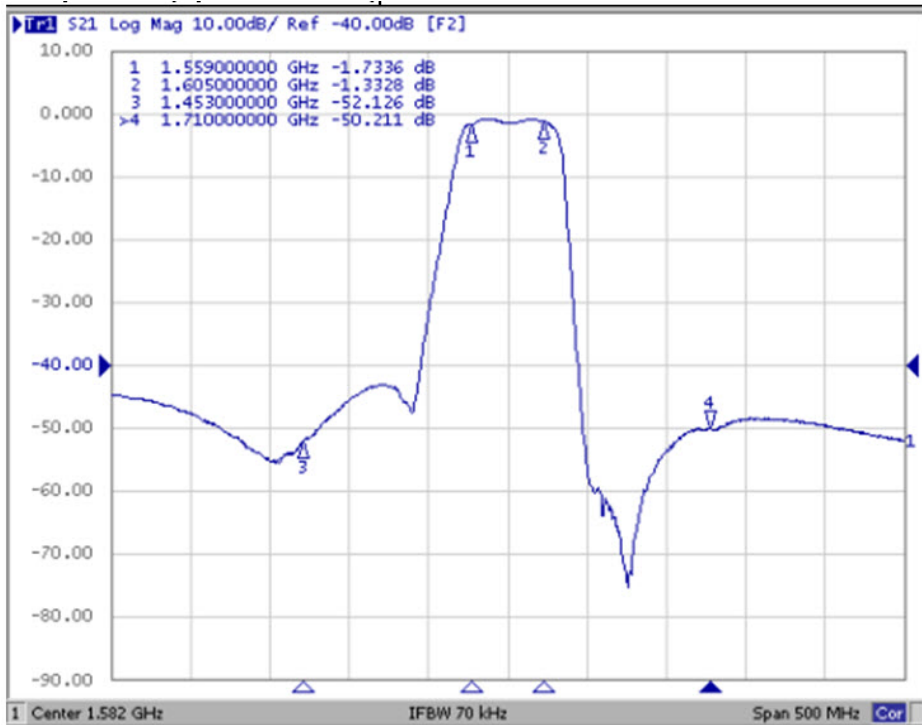

S21 Response: (span 3000 MHz)

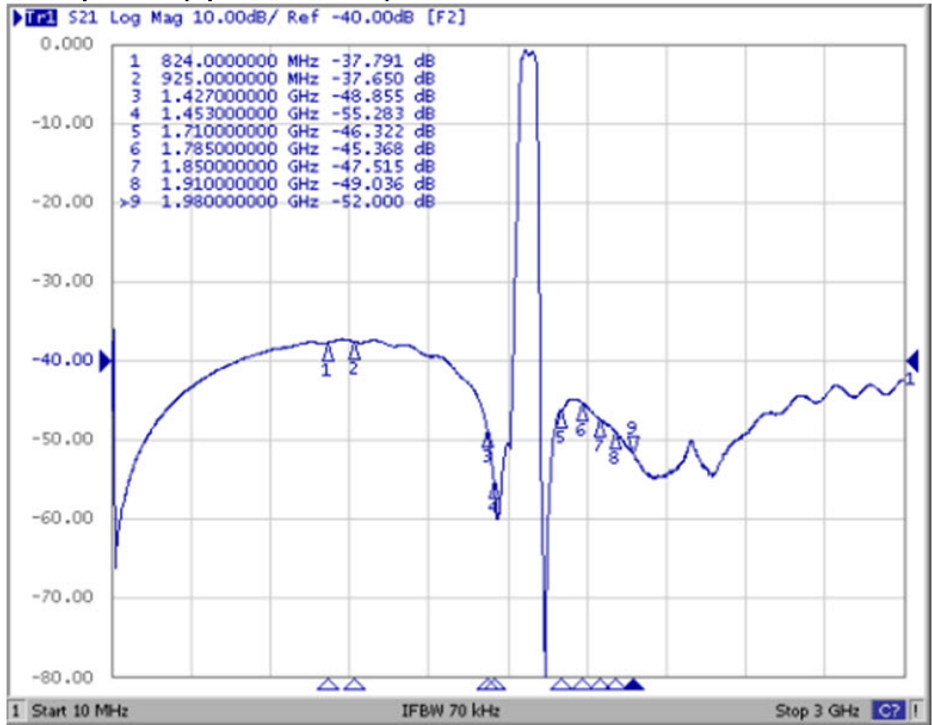

S11 and S22 VSWR: (span 100 MHz)

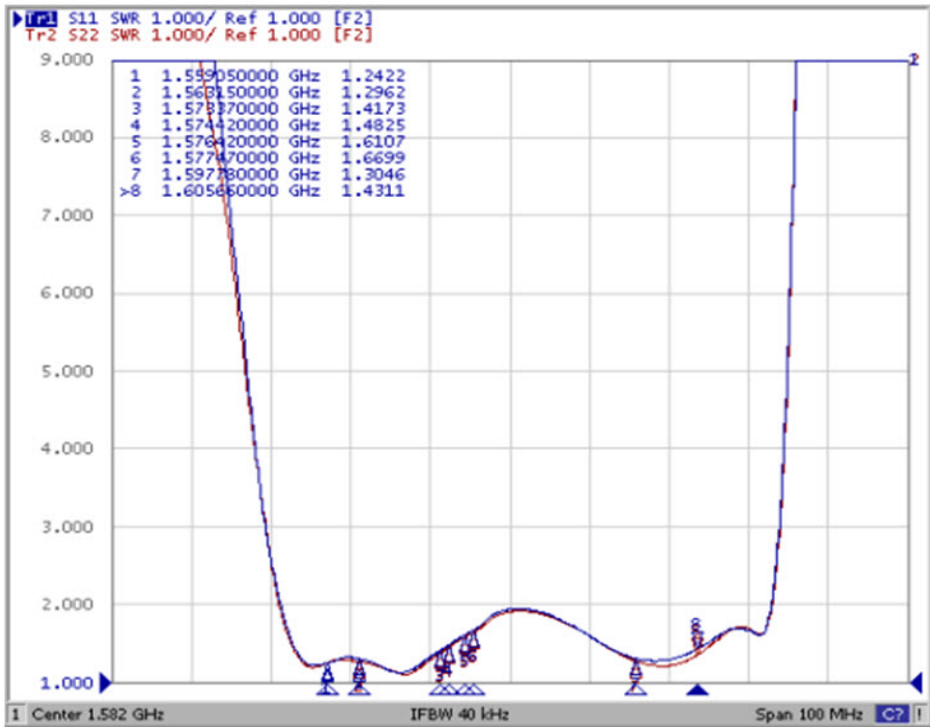

SM3030-6 Case

6-Terminal Ceramic Surface-Mount Case 3.0 X 3.0 mm Nominal Footprint

Case and PCB Footprint Dimensions

Dimension	mm			Inches		
	Min	Nom	Max	Min	Nom	Max
A	2.90	3.00	3.10	0.114	0.118	0.122
B	2.90	3.00	3.10	0.114	0.118	0.122
C	-	-	1.40	-	-	0.054
D	0.77	0.90	1.03	0.030	0.035	0.040
E	2.39	2.54	2.69	0.094	0.110	0.105
F	1.45	1.60	1.75	0.057	0.063	0.068
G	0.70	0.85	1.00	0.027	0.033	0.039
H	1.35	1.50	1.65	0.053	0.059	0.064
I	0.45	0.60	0.75	0.017	0.024	0.029
J	1.15	1.30	1.45	0.045	0.051	0.057
K	-	3.20	-	-	0.126	-
L	-	1.70	-	-	0.067	-
M	-	1.05	-	-	0.041	-
N	-	0.81	-	-	0.032	-
O	-	0.38	-	-	0.015	-

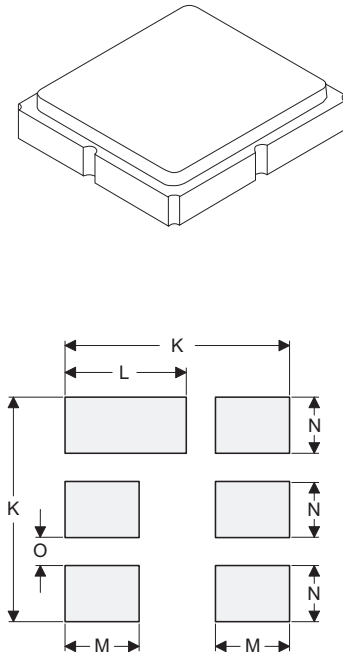

PCB Footprint Top View

Case Materials

Materials	
Solder Pad Plating	0.3 to 1.0 μm Gold over 1.27 to 8.89 μm Nickel
Lid Plating	2.0 to 3.0 μm Nickel
Body	Al_2O_3 Ceramic

Top View

Bottom View

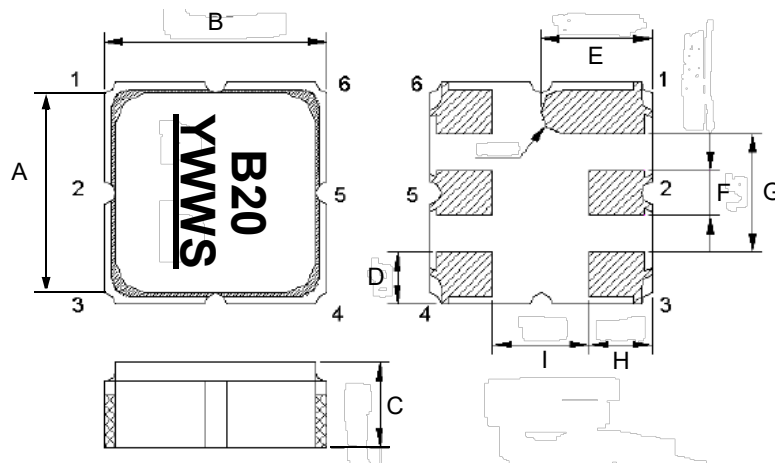

Tape and Reel Specifications

Tape and Reel Standard per ANSI/EIA-481

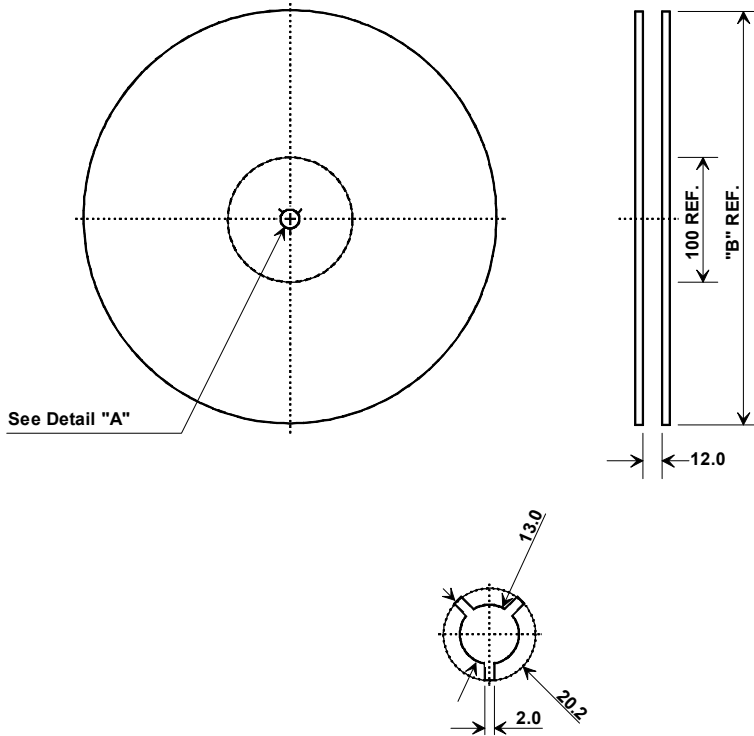

"B"		Quantity Per Reel
Inches	millimeters	
7	178	500
13	330	3000

Component Orientation and Dimensions

Carrier Tape Dimensions	
Ao	3.30 mm
Bo	3.30 mm
Ko	1.60 mm
Pitch	8.0 mm
W	12.0 mm

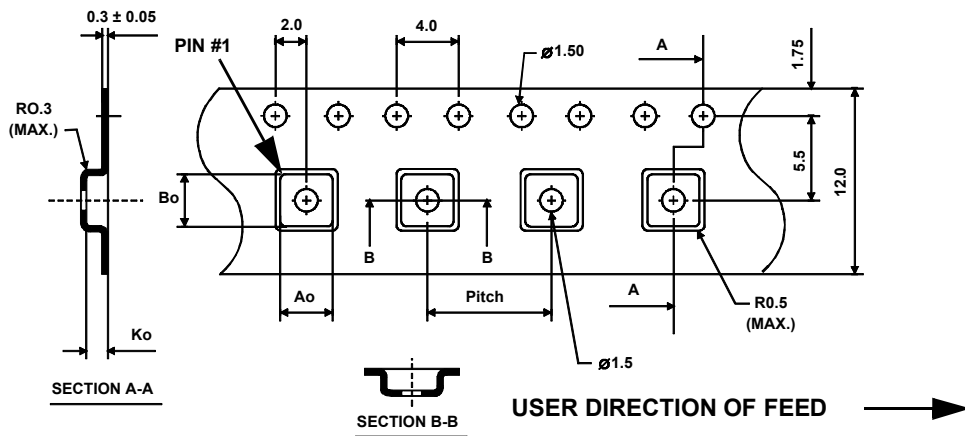

Recommended Reflow Profile

1. Preheating shall be fixed at 150~180°C for 60~90 seconds.
2. Ascending time to preheating temperature 150°C shall be 30 seconds min.
3. Heating shall be fixed at 220°C for 50~80 seconds and at 260°C +0/-5°C peak (10 seconds).
4. Time: 5 times maximum.

