



# American Opto Plus LED Corp.

## L933-SP275-2-30

3.5 x 3.5 x 1.6mm UVC SMD LED

### PACKAGE OUTLINES

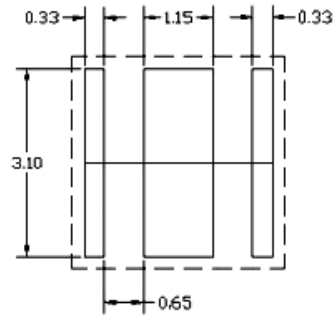
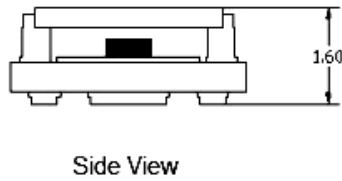
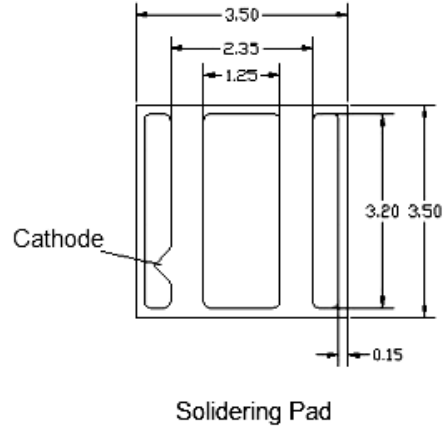
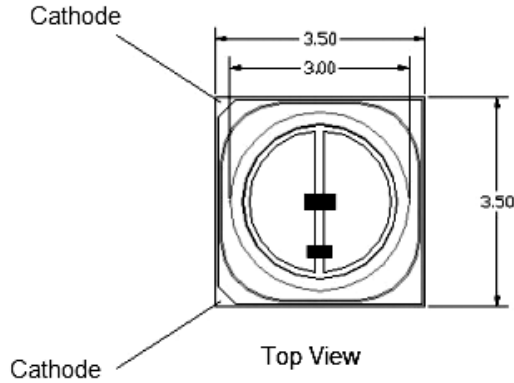

#### WARNING:

- UV LEDs emit light in the ultraviolet region (UV light).
- UV light is invisible and may be harmful to the human eye.
- Do not expose the eyes directly to the UV light. Wearing appropriate protective gear when handling.
- Use appropriate warning signs/ labels on the devices equipped with UV LEDs.

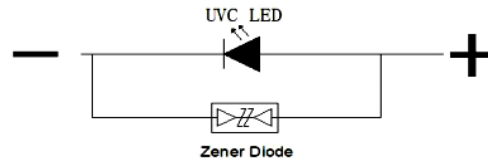

Item	Materials
Viewing Angle	120 Degree
Lens Color	Water Clear
Emitted Color	Ultra Violet

#### Notes:

1. All dimensions are in millimeters.
2. Tolerances are  $\pm 0.1$ mm unless otherwise noted.



# American Opto Plus LED Corp.

## L933-SP275-2-30

3.5 x 3.5 x 1.6mm UVC SMD LED

### ABSOLUTE MAXIMUM RATINGS

(Ta=25°C)

Parameter	Symbol	Value	Unit
Forward Current	If	60	mA
LED Junction Temperature	Tj	90	°C
Thermal resistance	Rth	55	°C/W
Operating Temperature Range	Top	-30 ~ +60	°C
Soldering Temperature	Tp	260°C for 5sec Max	

### ELECTRO-OPTICAL CHARACTERISTICS

(Ta=25°C)

Parameter	Test Condition	Symbol	Value			Unit
			Min	Typ	Max	
Peak Wavelength	If=30mA	$\lambda P$	270	275	280	nm
Forward Voltage		Vf	5	--	7.5	V
Radiant Output		Popt	2	3	--	mW
Spectral Half bandwidth		$\Delta\lambda$	--	9	--	nm
Viewing Angle at 50% Iv		2 $\theta$ 1/2	--	120	--	Deg

#### Note:

1. The tolerance of forward voltage is  $\pm 0.1V$ .
2. The tolerance of radiant output is  $\pm 8\%$ .
3. The tolerance of peak wavelength is  $\pm 3nm$ .



# American Opto Plus LED Corp.

## L933-SP275-2-30

3.5 x 3.5 x 1.6mm UVC SMD LED

### OPTICAL CHARACTERISTIC CURVES

Fig.1 Relative Radiant Power VS Forward Current( $T_a=25^{\circ}\text{C}$ ) Fig.2 Forward Current VS Forward Voltage ( $T_a=25^{\circ}\text{C}$ )

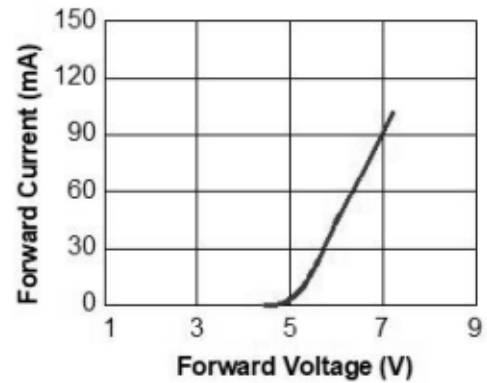
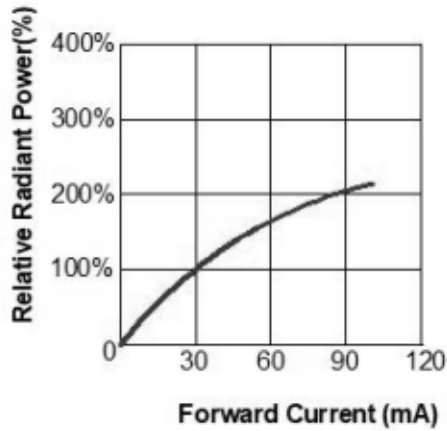

Fig.3 Forward Voltage VS Ambient Temperature

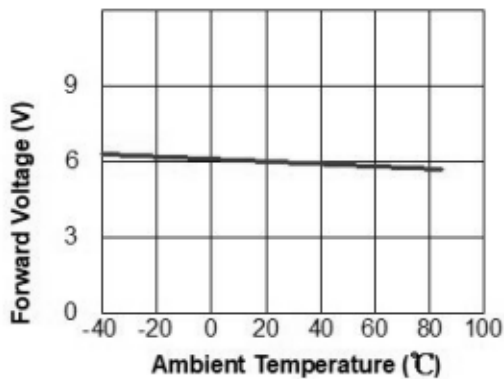
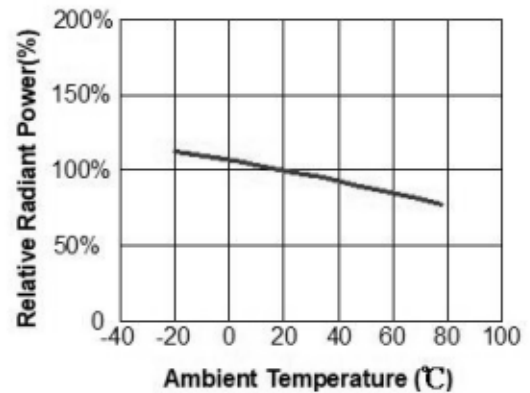

Fig.4 Relative Radiant Power VS Ambient Temperature





# American Opto Plus LED Corp.

## L933-SP275-2-30

3.5 x 3.5 x 1.6mm UVC SMD LED

Fig.5 Peak Wavelength VS Forward Current

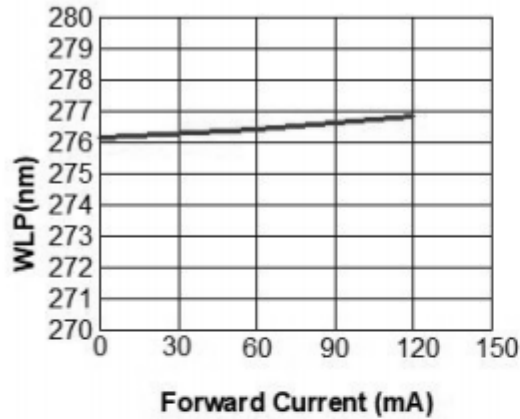

Fig.6 Forward Current VS Ambient Temperature

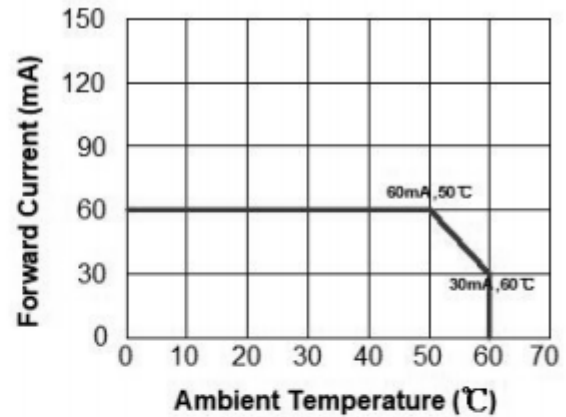

Fig.7 Relative Intensity VS WLP

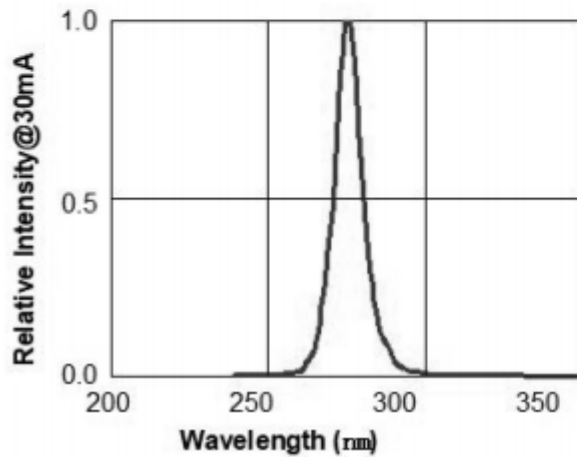
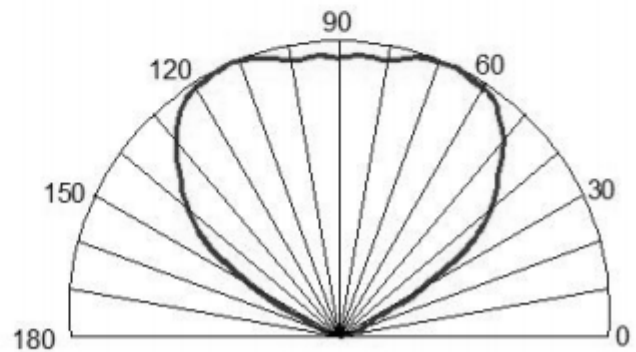

Fig.8 Radiation pattern @ 30mA





# American Opto Plus LED Corp.

## L933-SP275-2-30

3.5 x 3.5 x 1.6mm UVC SMD LED

### RELIABILITY TEST

Test Item	Test Conditions	Note	Failure Criteria
Life Test	$T_a=25^{\circ}\text{C}$ $I_F=60\text{mA}$	1000 hrs	Forward Voltage $V_F>120\%$
High Temperature Storage	$T_a=100^{\circ}\text{C}$	1000 hrs	
Low Temperature Storage	$T_a=-40^{\circ}\text{C}$	1000 hrs	Radiant Output $P_{opt}<70\%$
Temperature Cycle	$-40^{\circ}\text{C}$ 30min $\uparrow\downarrow$ $25^{\circ}\text{C}$ 5min $\uparrow\downarrow$ $100^{\circ}\text{C}$ 30min	100 cycle	



# American Opto Plus LED Corp.

## L933-SP275-2-30

3.5 x 3.5 x 1.6mm UVC SMD LED

### TAPE DIMENSION

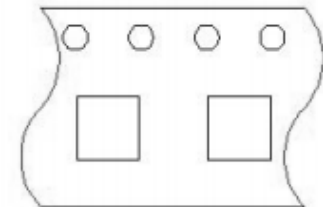
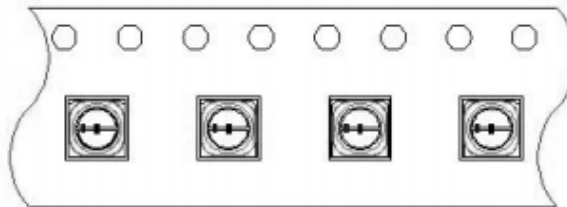
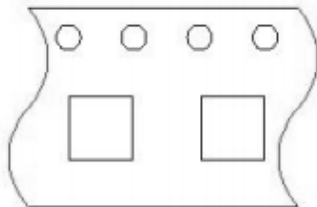
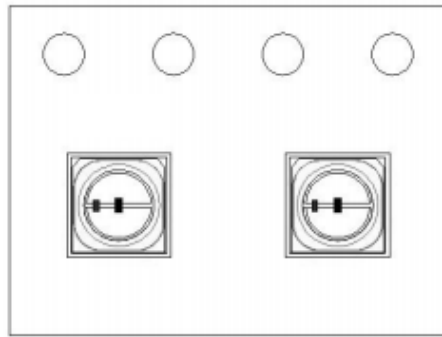
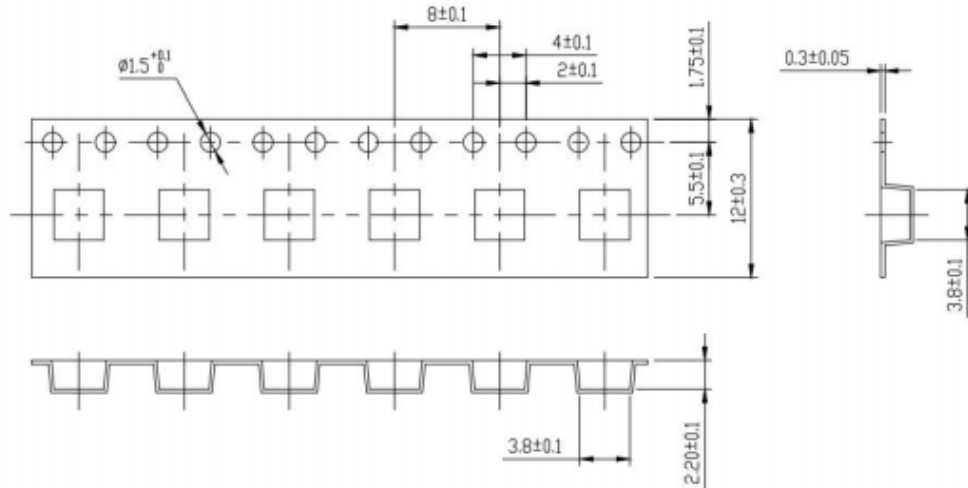

Empty Ports  
(200mm)

Empty Ports  
(400mm)

Note:

QTY/Reel: 1000 pcs Max.



# American Opto Plus LED Corp.

## L933-SP275-2-30

3.5 x 3.5 x 1.6mm UVC SMD LED

### REEL DIMENSION

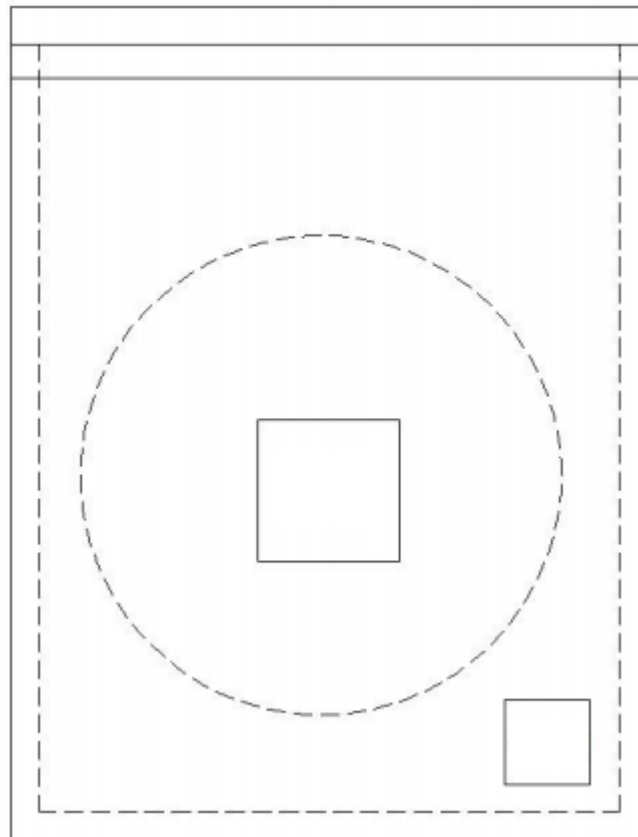
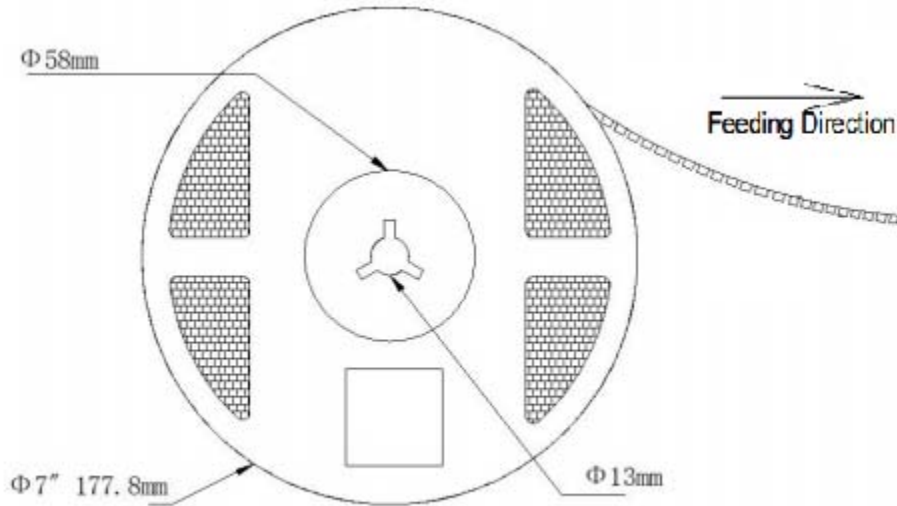



# American Opto Plus LED Corp.

## L933-SP275-2-30

### 3.5 x 3.5 x 1.6mm UVC SMD LED

#### REFLOW SOLIDERING PROFILE

Reflow Temp/time

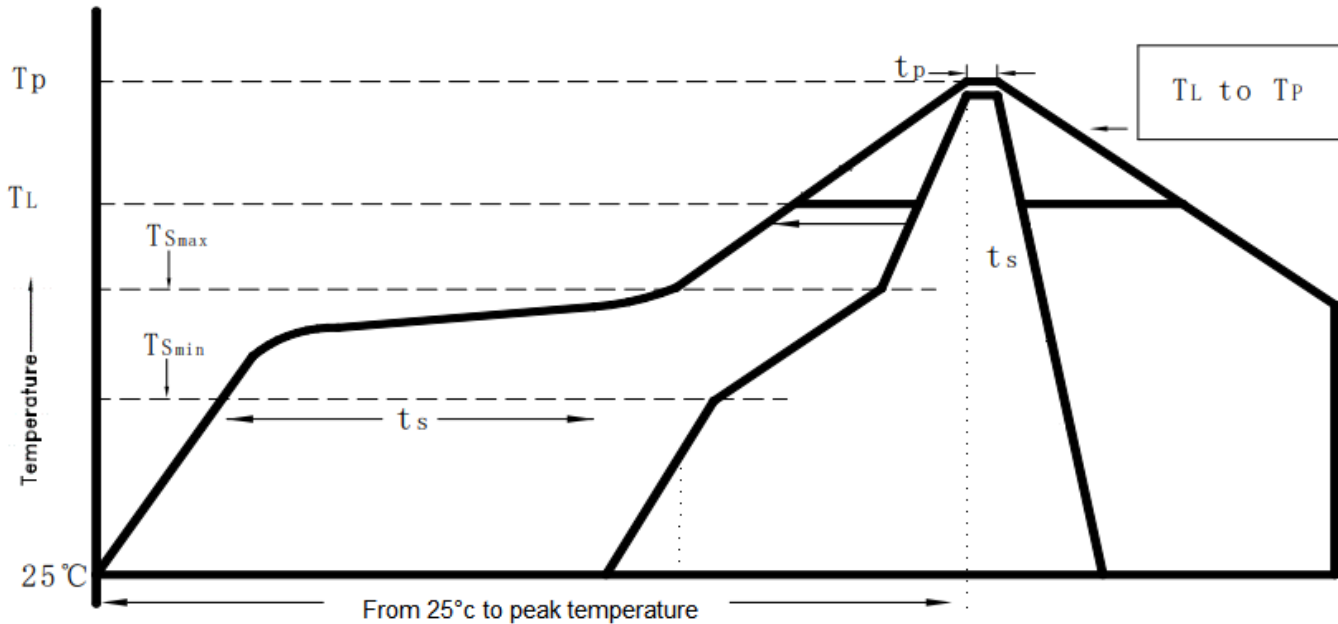

Stage	Parameter	Symbol	Value	Unit
Preheat	Ramp-up Rate	$T_{Smax}$ to $T_p$	1	°C/sec
	Min. Temperature	$T_{Smin}$	100-150	°C
	Max. Temperature	$T_{Smax}$	180-200	°C
	Time	$T_{Smin}$ to $T_{Smax}$	60-120	Sec
Equilibrium	Temperature	$T_L$	217	°C
	Temperature Time	$t_L$	50-80	Sec
Reflow	Peak Temperature	$T_p$	260	°C
	Time	$t_r$	20-40	Sec
Cooling	Ramp-down Rate	$V_c$	3	°C/sec
Preheat to Reflow	From 25°C to peak temperature	25°C to $T_p$	4 mins MAX.	





# American Opto Plus LED Corp.

## L933-SP275-2-30

3.5 x 3.5 x 1.6mm UVC SMD LED

### PRECAUTIONS FOR USE:

#### Storage time:

1. Calculated shelf life before opening is 6 months at 10-30°C and < 60% relative humidity (RH).
2. After bag is opened, devices which will be subjected to reflow soldering or other high temperature processes must be:
  - a) Assembled within 24 hour, or
  - b) Stored at Moisture Proof bag with desiccant.
3. Devices are required baking before assembly if:
  - a) Package is opened before.
  - b) 2.a) or 2.b) doesn't meet.
4. If baking is required, devices should be baked for 6 hours at 60°C.

#### ESD (Electrostatic Discharge):

Static Electricity or power surge will damage the LED. Use of a conductive wrist band or anti-electrostatic glove is recommended when handling these LED. All devices, equipment and machinery must be properly grounded.

#### Cleaning

In case where a minimal level of dirt and dust particles cannot be guaranteed, a suitable cleaning solution can be applied to the lens surface.

- Use alcohol-based cleaning solvents such as isopropyl alcohol to clean the LED.
- Try a gentle swabbing with lint-free swab.
- If need, the use of tint-free swab and isopropyl alcohol used gently removes dirt from the lens.
- Don't use other solvents as they may directly react with the LED assembly.
- Don't use ultrasonic cleaning that the LED will be damaged.

#### Over-Current-Proof

Customer must apply resistors for protection; otherwise slight voltage shift will cause big current change (Burn out will happen).