

LQH32NZ1R5K23#

“#” indicates a package specification code.

It can be used in 105 °C environment.



< List of part numbers with package codes >
LQH32NZ1R5K23K LQH32NZ1R5K23L

Applications

Unsuitable Applications	Please be sure to read and comply with these "Precautions for use."
Specific Applications	Consumer equipment, Automotive infotainment/comfort equipment, Medical equipment [GHTE A/B/C] except for implant & operation & auto-dispenser equipment, Industrial equipment except for transportation & facility & energy equipment Please refer to Our Website and specifications, etc. for information about the performance, functions, quality, management, and safety required for the above applications, and use Products after confirming the performance and reliability of the actual Product.

Notices

When rated current is applied to the products, self-temperature rise shall be limited to 20°C max and inductance will be within ±10% of initial inductance value.

References

Packaging	Specifications	Standard Packing Quantity
K	330 Embossed Tape	7500
L	180 Embossed Tape	2000

Appearance & Shape

Mass (typ.)	
1 piece	0.06g

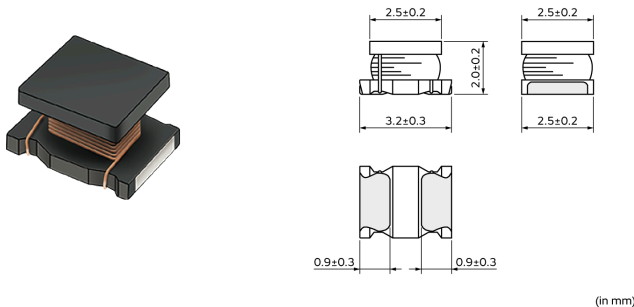

Attention
1. This datasheet is downloaded from the website of Murata Manufacturing Co., Ltd. Therefore, its specifications are subject to change or our products in it may be discontinued without advance notice. Please check with our sales representatives or product engineers before ordering.
2. This datasheet has only typical specifications because there is no space for detailed specifications. Therefore, please review our product specifications or consult the approval sheet for product specifications before ordering.

LQH32NZ1R5K23#

“#” indicates a package specification code.



Specifications

L size	3.2±0.3mm
W size	2.5±0.2mm
T size	2.0±0.2mm
Size code inch (mm)	1210 (3225)
Inductance	1.5μH±10%
Inductance Test Frequency	1MHz
Rated current (Itemp) (Based on Temperature rise)	400mA
Max. of DC resistance	0.6Ω
Class of magnetic shield	No Shield
Q(min.)	20
Q Test Frequency	1MHz
Self resonance frequency (min.)	75MHz
Brand	Murata
Operating Temperature Range	-40°C to 105°C
Series	LQH32NZ_23

Attention

1.This datasheet is downloaded from the website of Murata Manufacturing Co., Ltd. Therefore, it's specifications are subject to change or our products in it may be discontinued without advance notice. Please check with our sales representatives or product engineers before ordering.

2.This datasheet has only typical specifications because there is no space for detailed specifications.

Therefore, please review our product specifications or consult the approval sheet for product specifications before ordering.

LQH32NZ1R5K23#

"#" indicates a package specification code.



Characteristic Data

The charts below may show another part number which shares its characteristics.

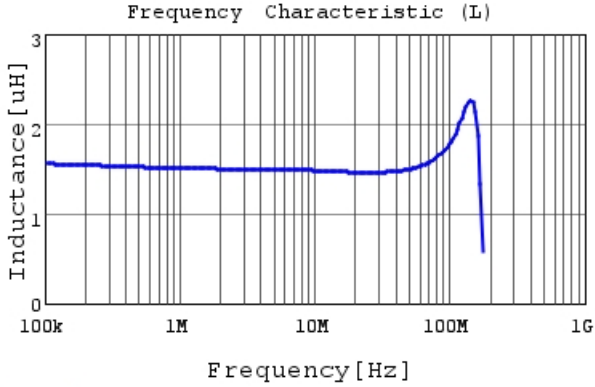

LQH32NZ1R5K23 L

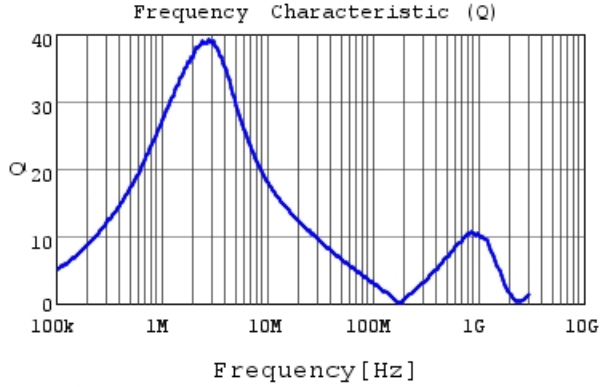

LQH32NZ1R5K23 Q

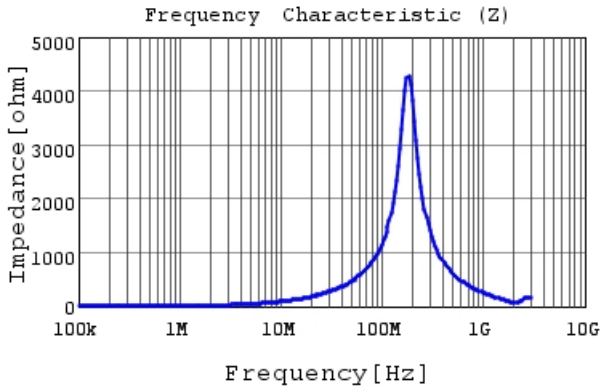

LQH32NZ1R5K23 |Z|

Attention

- 1.This datasheet is downloaded from the website of Murata Manufacturing Co., Ltd. Therefore, it's specifications are subject to change or our products in it may be discontinued without advance notice. Please check with our sales representatives or product engineers before ordering.
- 2.This datasheet has only typical specifications because there is no space for detailed specifications. Therefore, please review our product specifications or consult the approval sheet for product specifications before ordering.