

TINA-Y-RS-WHT

~14° spot beam. Assembly with holder, installation tape and pins. White version

SPECIFICATION:

Dimensions	Ø 16.1 mm
Height	10 mm
Fastening	tape, pin
ROHS compliant	yes ⓘ

MATERIALS:

Component	Type	Material	Colour	Finish
TINA-Y-RS	Single lens	PMMA	clear	gloss
TINA-Y-HLD-WHT	Holder	PC	white	
TINA-Y-TAPE	Tape	Acrylic foam		

ORDERING INFORMATION:

Component	Qty in box	MOQ	MPQ	Box weight (kg)
CA18476_TINA-Y-RS-WHT » Box size: 476 x 273 x 197 mm	3900	300	300	5.7

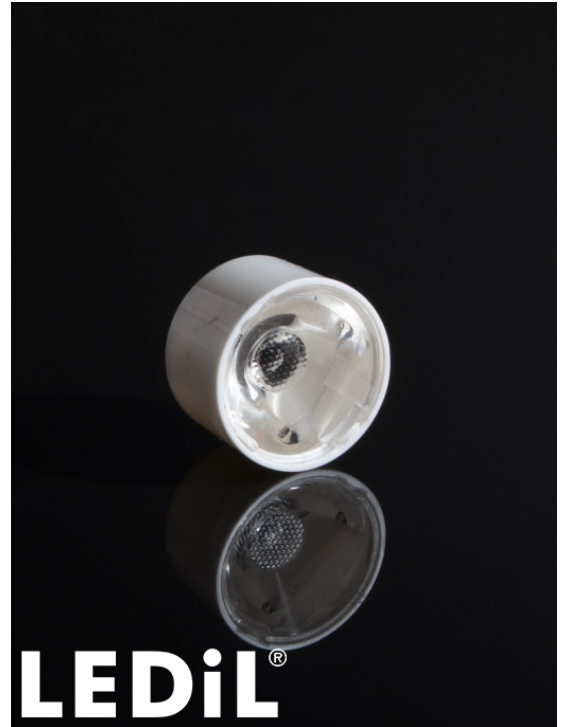

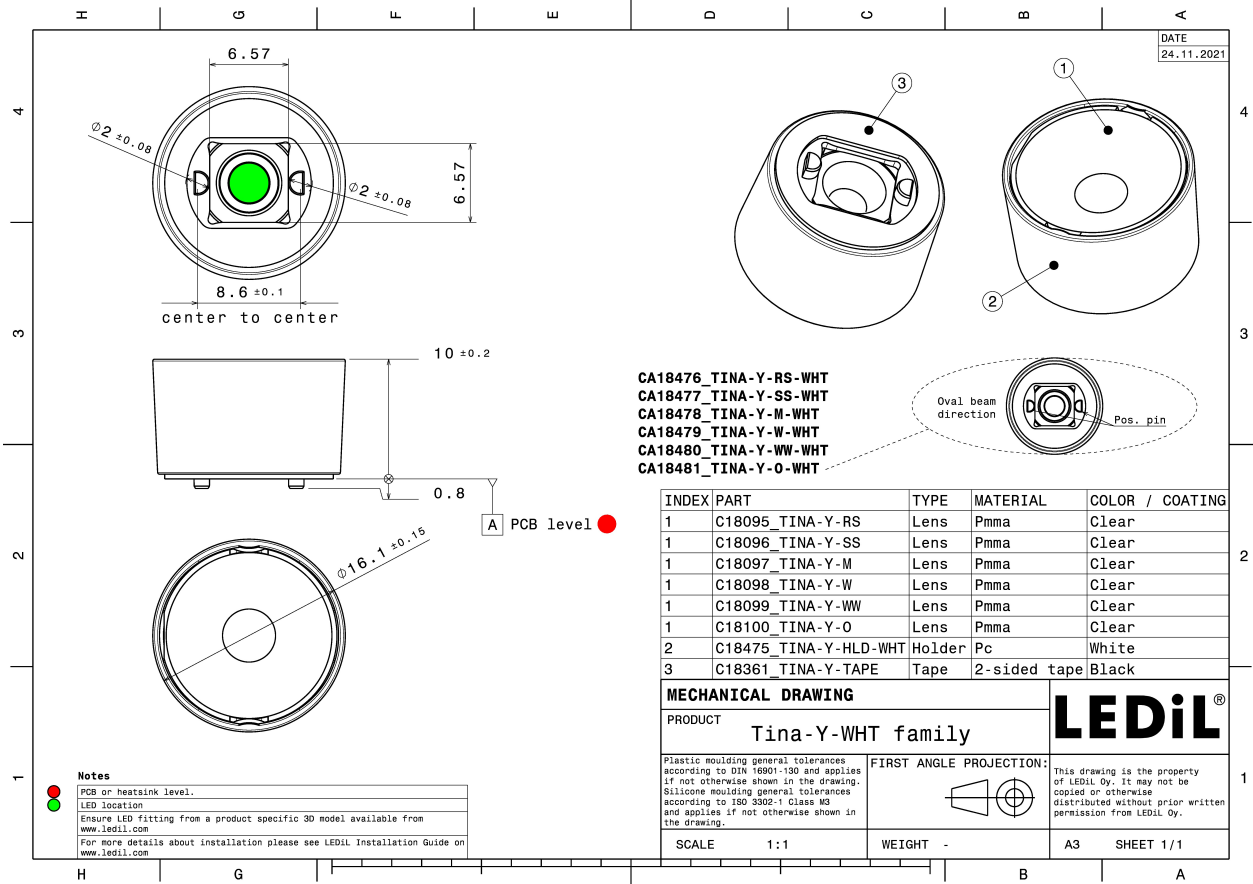

See also our general installation guide: www.ledil.com/installation_guide

OPTICAL RESULTS (MEASURED):



LED XP-G3
 FWHM / FWTM 18.0° / 36.0°
 Efficiency 88 %
 Peak intensity 5.8 cd/m
 LEDs/each optic 1
 Light colour White
 Required components:

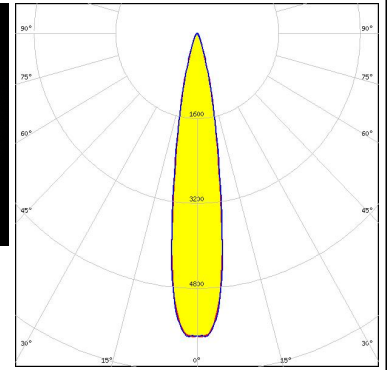
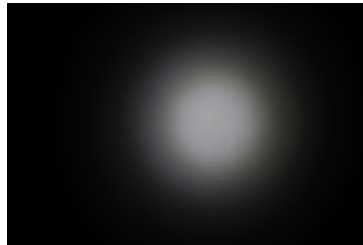

LED NVSW719AC
 FWHM / FWTM 16.0° / 27.0°
 Efficiency 94 %
 Peak intensity 8.9 cd/m
 LEDs/each optic 1
 Light colour White
 Required components:

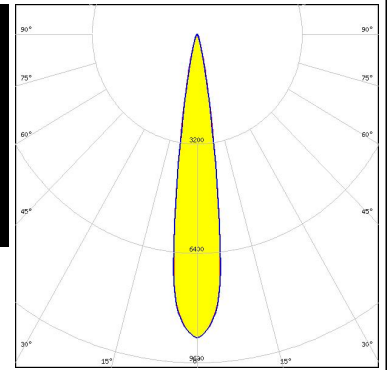

OPTICAL RESULTS (SIMULATED):

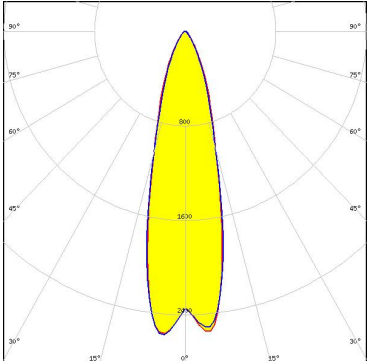
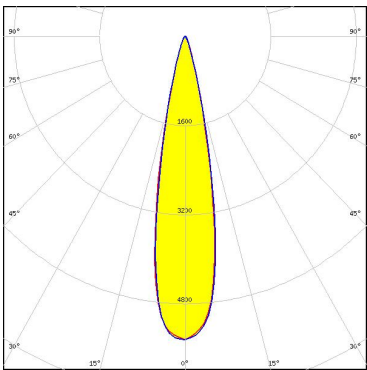
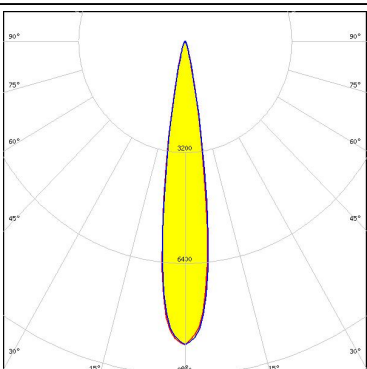
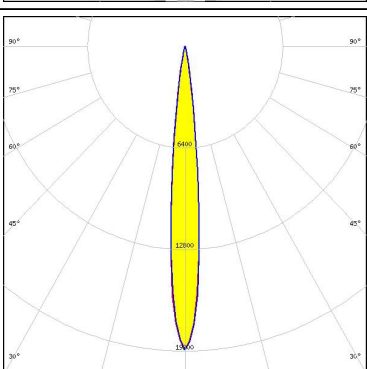
<p>LUMILEDS</p> <p>LED LUXEON 5050 Square LES</p> <p>FWHM / FWTM 27.0° / 58.0°</p> <p>Efficiency 90 %</p> <p>Peak intensity 2.6 cd/lm</p> <p>LEDs/each optic 1</p> <p>Light colour White</p> <p>Required components:</p>	
<p>LUMILEDS</p> <p>LED LUXEON HL2X</p> <p>FWHM / FWTM 22.0° / 36.0°</p> <p>Efficiency 94 %</p> <p>Peak intensity 5.4 cd/lm</p> <p>LEDs/each optic 1</p> <p>Light colour White</p> <p>Required components:</p>	
<p>OSRAM Opto Semiconductors</p> <p>LED OSOLON Square CSSRM2/CSSRM3</p> <p>FWHM / FWTM 16.0° / 28.0°</p> <p>Efficiency 95 %</p> <p>Peak intensity 8.7 cd/lm</p> <p>LEDs/each optic 1</p> <p>Light colour White</p> <p>Required components:</p>	
<p>OSRAM Opto Semiconductors</p> <p>LED OSOLON SSL 150</p> <p>FWHM / FWTM 10.0° / 20.0°</p> <p>Efficiency 96 %</p> <p>Peak intensity 19.1 cd/lm</p> <p>LEDs/each optic 1</p> <p>Light colour White</p> <p>Required components:</p>	

OPTICAL RESULTS (SIMULATED):

SAMSUNG

LED	LH351B
FWHM / FWTM	18.0° / 32.0°
Efficiency	95 %
Peak intensity	7.2 cd/lm
LEDs/each optic	1
Light colour	White
Required components:	

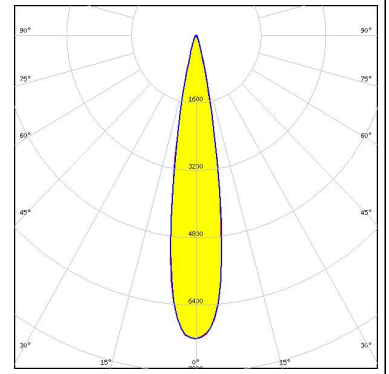

GENERAL INFORMATION:

NOTE: The typical beam angle will be changed by different color, chip size and chip position tolerance. The typical total beam angle is the full angle measured where the luminous intensity is half of the peak value.

MATERIALS:

As part of our continuous research and improvement processes, and to ensure the best possible quality and availability of our products, LEDiL reserves the right to change material grades without notice.

PRODUCT DATA USER AGREEMENT AND DISCLAIMER:

The measured data in the provided downloadable LEDiL Product Datasheets and Mechanical 2D-Drawings is rounded and provided as reference for planning. LEDiL Oy's optical specifications have been verified by conducting performance testing of the products in accordance with the company's quality system. The reported data are averaged results of multiple measurements with typical variation. LEDiL Oy reserves the right to without prior notification make changes and improvements to its products.

LEDiL Oy assumes neither warranty, nor guarantee nor any other liability of any kind for the contents and correctness of the provided data. The provided data has been generated with highest diligence but the provided data may in reality not represent the complete possible variation range of all intrinsic parameters. Therefore, in certain cases a deviation from the provided data could occur.

LEDiL Oy reserves the right to undertake technical changes of its products without further notification which could lead to changes in the provided data. LEDiL Oy assumes no liability of any kind for the possible deviation from any provided data or any other damage resulting from the usage of the provided data.

The user agrees to this disclaimer and user agreement with the download or usage of the provided files.

LEDiL Oy

Joensuunkatu 13
FI-24240 SALO
Finland

LEDiL Inc.

228 West Page Street
Suite D
Sycamore IL 60178
USA

Ledil Optics Technology (Shenzhen) Co., Ltd.

405 , Block B
Casic Motor Building
Shenzhen 518057
P.R.CHINA

Local sales and technical support

[www.ledil.com/
where_to_buy](http://www.ledil.com/where_to_buy)

Shipping locations

Salo, Finland
Hong Kong, China

Distribution Partners

[www.ledil.com/
where_to_buy](http://www.ledil.com/where_to_buy)