

## Automotive-grade N-channel 80 V, 3.15 mΩ typ., 120 A STripFET™ F7 Power MOSFET in a PowerFLAT™ 5x6 package

Datasheet - production data

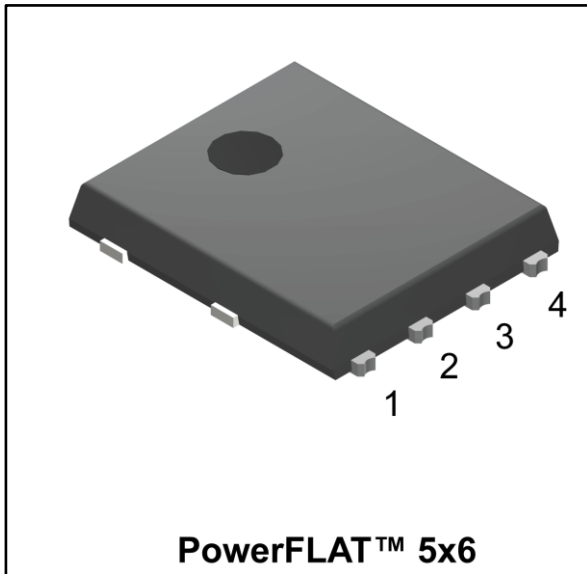

Figure 1: Internal schematic diagram

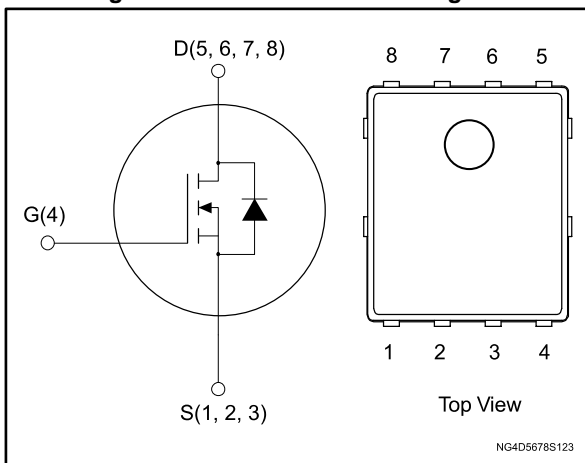

Table 1: Device summary

Order code	Marking	Package	Packing
STL135N8F7AG	135N8F7	PowerFLAT™ 5x6	Tape and reel

### Features

Order code	V <sub>DS</sub>	R <sub>DS(on)</sub> max.	I <sub>D</sub>	P <sub>TOT</sub>
STL135N8F7AG	80 V	3.6 mΩ	120 A	135 W

- Designed for automotive applications and AEC-Q101 qualified
- Among the lowest R<sub>DS(on)</sub> on the market
- Excellent FoM (figure of merit)
- Low C<sub>rss</sub>/C<sub>iss</sub> ratio for EMI immunity
- High avalanche ruggedness
- Wettable flank package

### Applications

- Switching applications

### Description

This N-channel Power MOSFET utilizes STripFET™ F7 technology with an enhanced trench gate structure that results in very low on-state resistance, while also reducing internal capacitance and gate charge for faster and more efficient switching.

---

# Contents

- 1 Electrical ratings ..... 3**
- 2 Electrical characteristics ..... 4**
  - 2.1 Electrical characteristics (curves) ..... 6
- 3 Test circuits ..... 8**
- 4 Package information ..... 9**
  - 4.1 PowerFLAT™ 5x6 WF type C package information ..... 9
  - 4.2 PowerFLAT™ 5x6 WF packing information ..... 12
- 5 Revision history ..... 14**



# 1 Electrical ratings

**Table 2: Absolute maximum ratings**

Symbol	Parameter	Value	Unit
$V_{DS}$	Drain-source voltage	80	V
$V_{GS}$	Gate-source voltage	$\pm 20$	V
$I_D^{(1)}$	Drain current (continuous) at $T_{case} = 25\text{ }^\circ\text{C}$	120	A
	Drain current (continuous) at $T_{case} = 100\text{ }^\circ\text{C}$	98	
$I_{DM}^{(1)(2)}$	Drain current (pulsed)	480	A
$I_D^{(3)}$	Drain current (continuous) at $T_{pcb} = 25\text{ }^\circ\text{C}$	26	A
	Drain current (continuous) at $T_{pcb} = 100\text{ }^\circ\text{C}$	19	
$I_{DM}^{(2)(3)}$	Drain current (pulsed)	104	A
$P_{TOT}^{(1)}$	Total dissipation at $T_{case} = 25\text{ }^\circ\text{C}$	135	W
$P_{TOT}^{(3)}$	Total dissipation at $T_{pcb} = 25\text{ }^\circ\text{C}$	4.8	W
$E_{AS}^{(4)}$	Single pulse avalanche energy	1.2	J
$T_{stg}$	Storage temperature range	-55 to 175	$^\circ\text{C}$
$T_j$	Operating junction temperature range		

**Notes:**

- (1) This value is rated according to  $R_{thj-c}$
- (2) Pulse width is limited by safe operating area
- (3) This value is rated according to  $R_{thj-pcb}$
- (4) Starting  $T_j = 25\text{ }^\circ\text{C}$ ,  $I_D = 13\text{ A}$ ,  $V_{DD} = 50\text{ V}$

**Table 3: Thermal data**

Symbol	Parameter	Value	Unit
$R_{thj-pcb}^{(1)}$	Thermal resistance junction-pcb	31.3	$^\circ\text{C/W}$
$R_{thj-case}$	Thermal resistance junction-case	1.1	

**Notes:**

- (1) When mounted on a 1-inch<sup>2</sup> FR-4 board, 2oz Cu,  $t < 10\text{ s}$

## 2 Electrical characteristics

( $T_{\text{case}} = 25\text{ °C}$  unless otherwise specified)

**Table 4: Static**

Symbol	Parameter	Test conditions	Min.	Typ.	Max.	Unit
$V_{(BR)DSS}$	Drain-source breakdown voltage	$V_{GS} = 0\text{ V}$ , $I_D = 250\text{ }\mu\text{A}$	80			V
$I_{DSS}$	Zero gate voltage drain current	$V_{GS} = 0\text{ V}$ , $V_{DS} = 80\text{ V}$			1	$\mu\text{A}$
		$V_{GS} = 0\text{ V}$ , $V_{DS} = 80\text{ V}$ , $T_j = 125\text{ °C}^{(1)}$			10	
$I_{GSS}$	Gate-body leakage current	$V_{DS} = 0\text{ V}$ , $V_{GS} = 20\text{ V}$			100	nA
$V_{GS(th)}$	Gate threshold voltage	$V_{DS} = V_{GS}$ , $I_D = 250\text{ }\mu\text{A}$	2.5		4.5	V
$R_{DS(on)}$	Static drain-source on-resistance	$V_{GS} = 10\text{ V}$ , $I_D = 13\text{ A}$		3.15	3.6	m $\Omega$

**Notes:**

<sup>(1)</sup>Defined by design, not subject to production test

**Table 5: Dynamic**

Symbol	Parameter	Test conditions	Min.	Typ.	Max.	Unit
$C_{iss}$	Input capacitance	$V_{DS} = 40\text{ V}$ , $f = 1\text{ MHz}$ , $V_{GS} = 0\text{ V}$	-	6800	-	$\mu\text{F}$
$C_{oss}$	Output capacitance		-	1350	-	
$C_{rss}$	Reverse transfer capacitance		-	95	-	
$Q_g$	Total gate charge	$V_{DD} = 40\text{ V}$ , $I_D = 26\text{ A}$ , $V_{GS} = 10\text{ V}$ (see <a href="#">Figure 14: "Test circuit for gate charge behavior"</a> )	-	103	-	nC
$Q_{gs}$	Gate-source charge		-	35	-	
$Q_{gd}$	Gate-drain charge		-	28	-	

**Table 6: Switching times**

Symbol	Parameter	Test conditions	Min.	Typ.	Max.	Unit
$t_{d(on)}$	Turn-on delay time	$V_{DD} = 40\text{ V}$ , $I_D = 13\text{ A}$ $R_G = 4.7\text{ }\Omega$ , $V_{GS} = 10\text{ V}$ (see <a href="#">Figure 13: "Test circuit for resistive load switching times"</a> and <a href="#">Figure 18: "Switching time waveform"</a> )	-	30	-	ns
$t_r$	Rise time		-	28	-	
$t_{d(off)}$	Turn-off delay time		-	73	-	
$t_f$	Fall time		-	30	-	

Table 7: Source-drain diode

Symbol	Parameter	Test conditions	Min.	Typ.	Max.	Unit
$I_{SD}$	Source-drain current		-		26	A
$I_{SDM}^{(1)}$	Source-drain current (pulsed)		-		104	A
$V_{SD}^{(2)}$	Forward on voltage	$V_{GS} = 0\text{ V}$ , $I_{SD} = 26\text{ A}$	-		1.2	V
$t_{rr}$	Reverse recovery time	$I_{SD} = 26\text{ A}$ , $di/dt = 100\text{ A}/\mu\text{s}$ , $V_{DD} = 64\text{ V}$ (see <a href="#">Figure 15: "Test circuit for inductive load switching and diode recovery times"</a> )	-	47		ns
$Q_{rr}$	Reverse recovery charge		-	66		nC
$I_{RRM}$	Reverse recovery current		-	2.8		A

**Notes:**

- (1) Pulse width is limited by safe operating area  
(2) Pulse test: pulse duration = 300  $\mu\text{s}$ , duty cycle 1.5%

## 2.1 Electrical characteristics (curves)

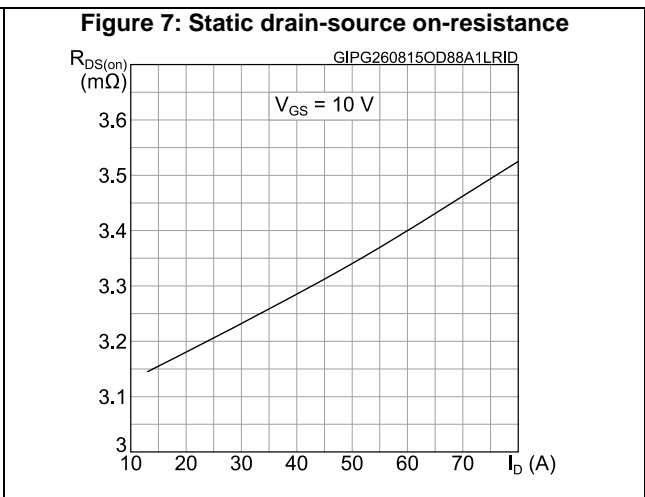
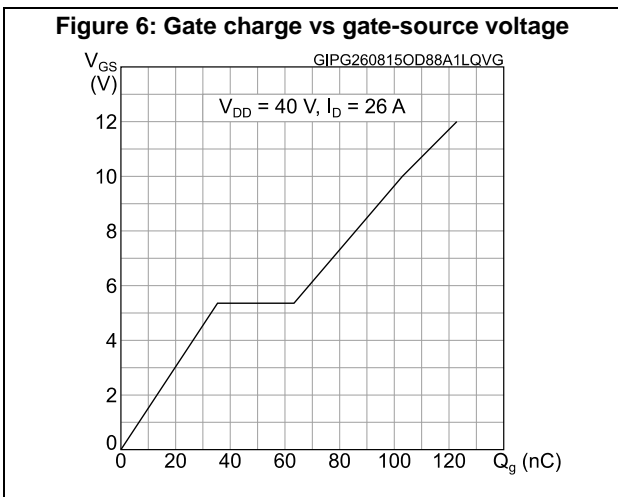
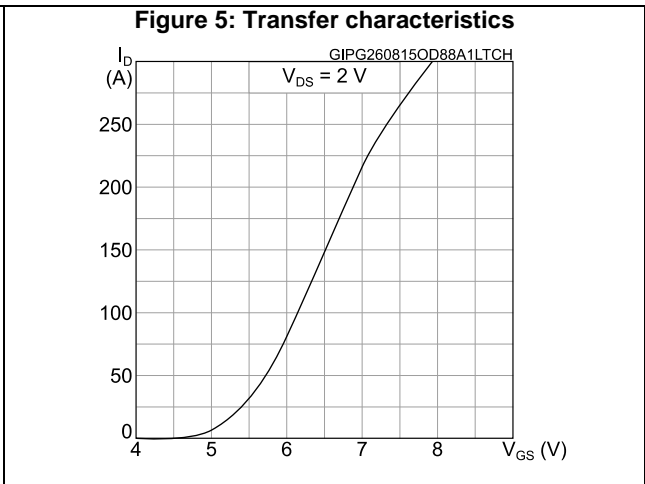
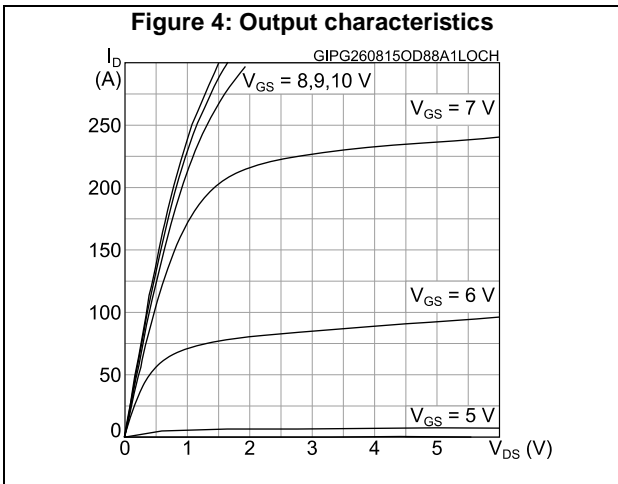
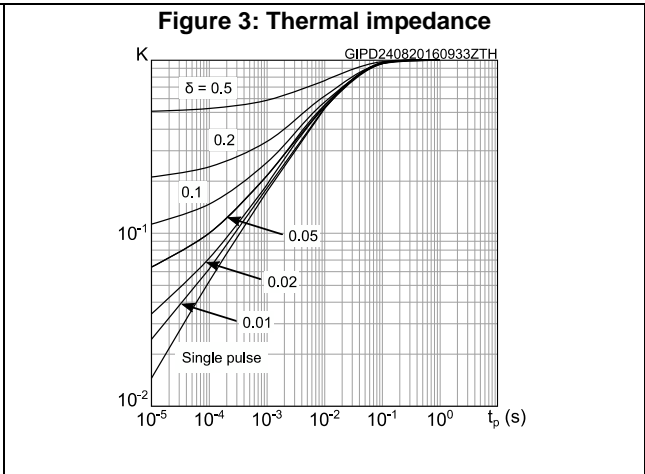
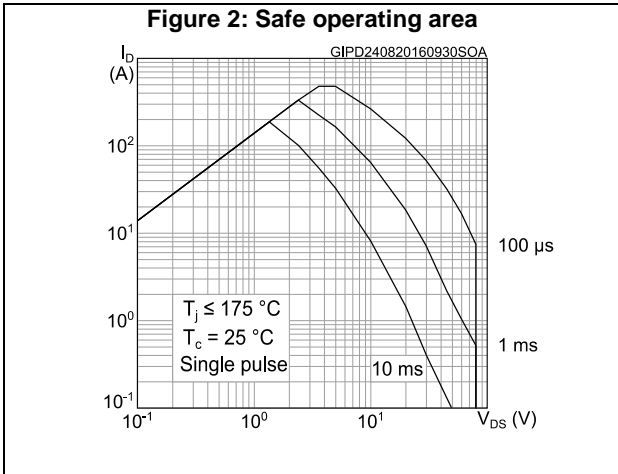

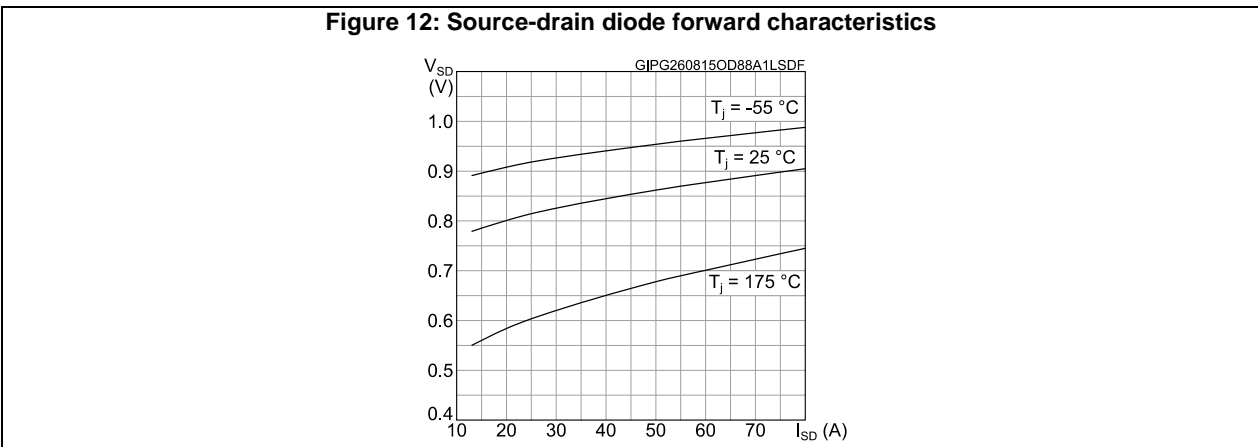
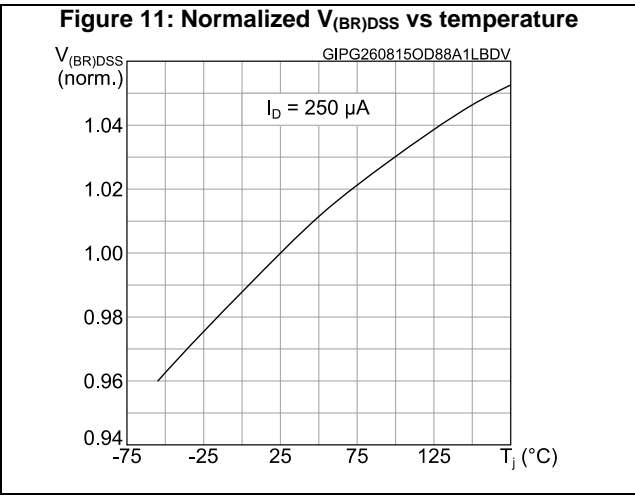
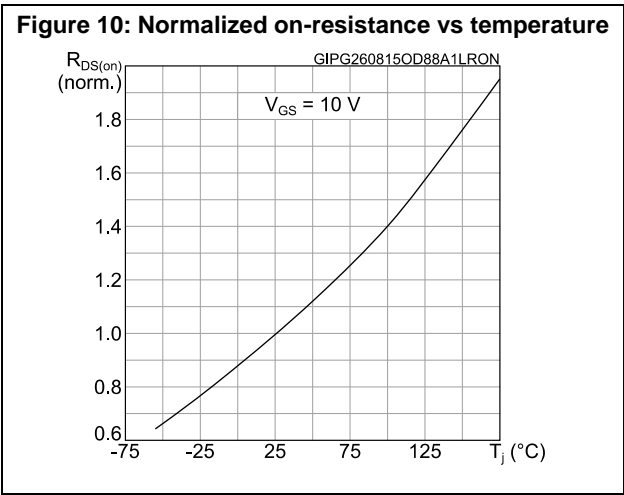
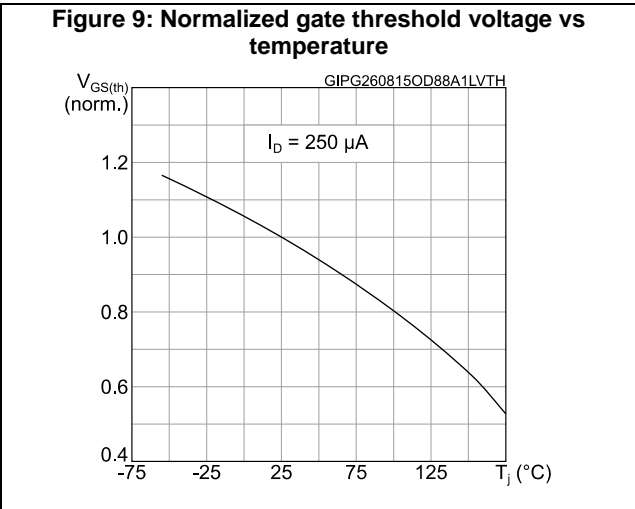
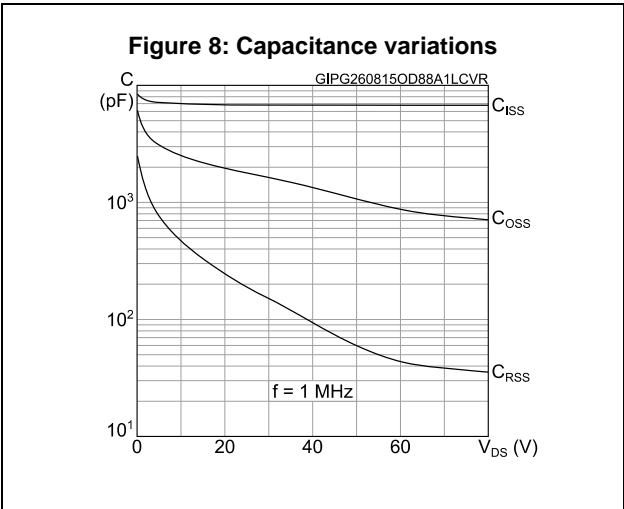

### 3 Test circuits

**Figure 13: Test circuit for resistive load switching times**



AM01468v1

**Figure 14: Test circuit for gate charge behavior**



AM01469v1

**Figure 15: Test circuit for inductive load switching and diode recovery times**

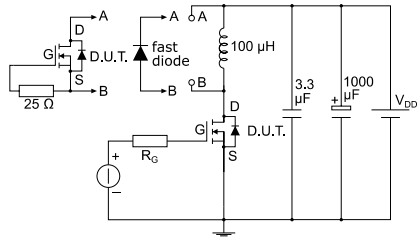

AM01470v1

**Figure 16: Unclamped inductive load test circuit**

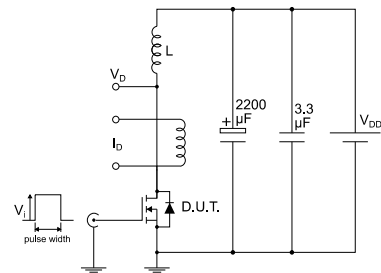

AM01471v1

**Figure 17: Unclamped inductive waveform**

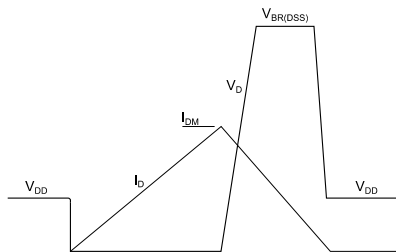

AM01472v1

**Figure 18: Switching time waveform**

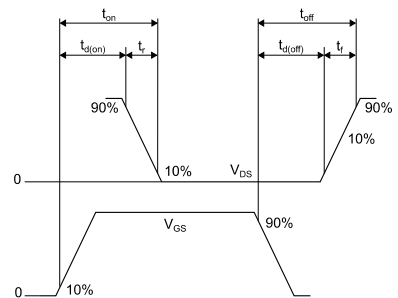

AM01473v1



## 4 Package information

In order to meet environmental requirements, ST offers these devices in different grades of ECOPACK® packages, depending on their level of environmental compliance. ECOPACK® specifications, grade definitions and product status are available at: [www.st.com](http://www.st.com). ECOPACK® is an ST trademark.

### 4.1 PowerFLAT™ 5x6 WF type C package information

Figure 19: PowerFLAT™ 5x6 WF type C package outline

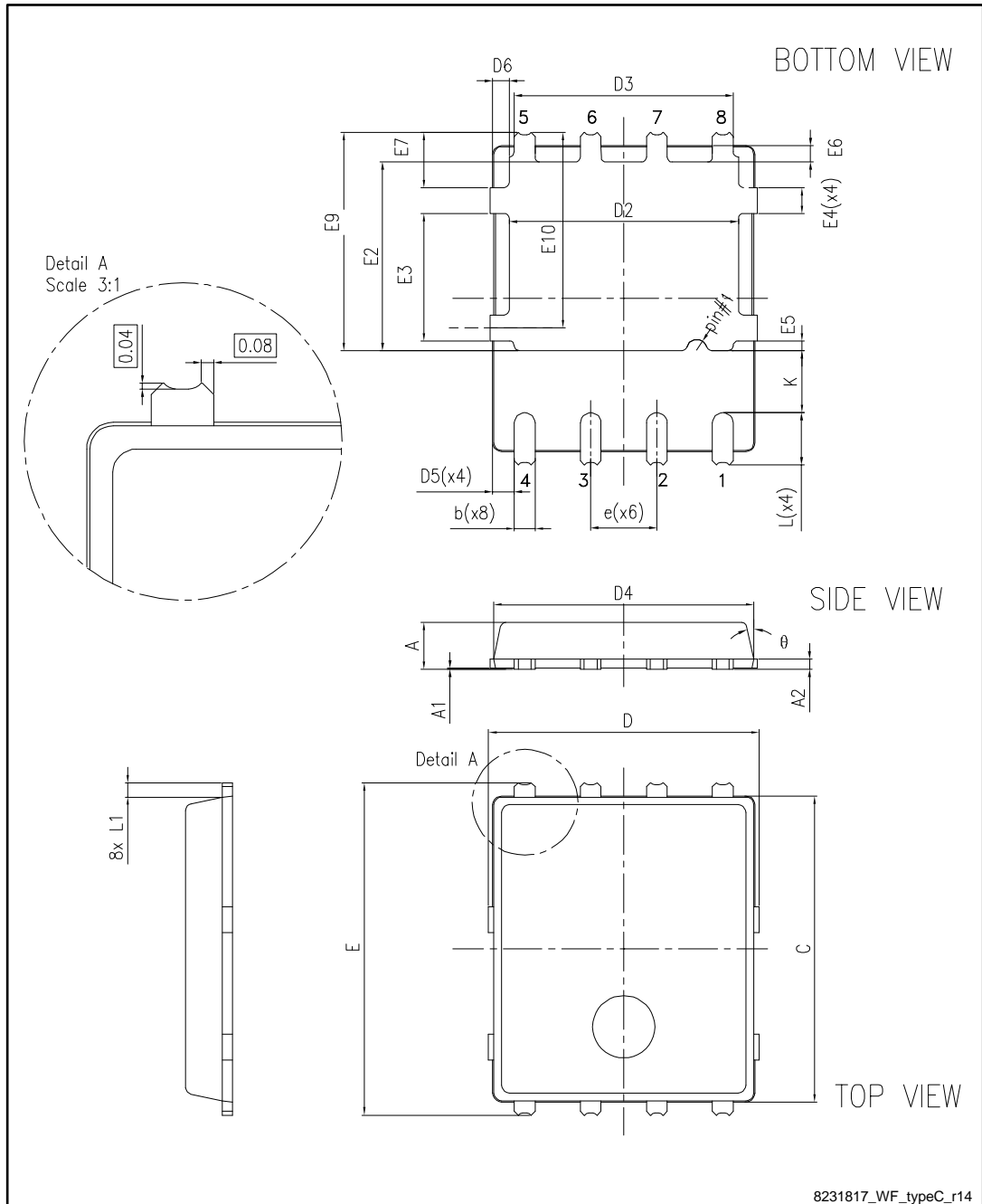
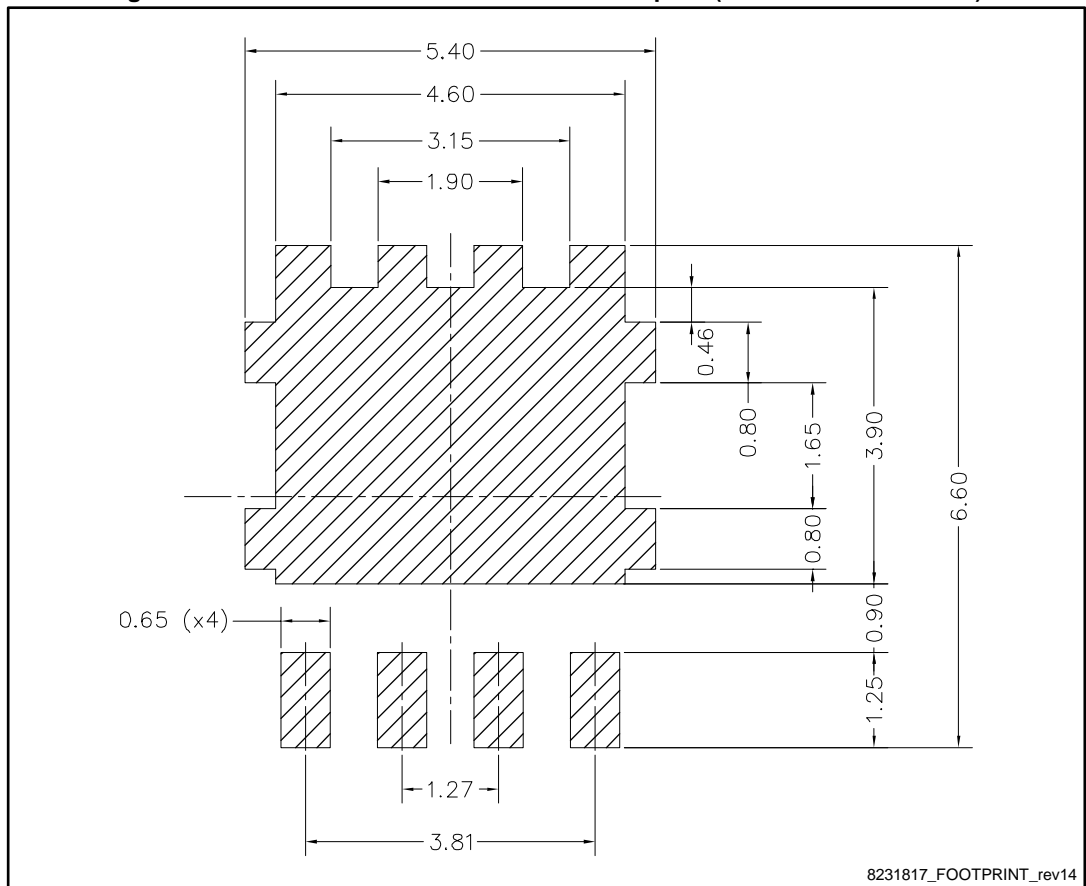

Table 8: PowerFLAT™ 5x6 WF type C mechanical data

Dim.	mm		
	Min.	Typ.	Max.
A	0.80		1.00
A1	0.02		0.05
A2		0.25	
b	0.30		0.50
C	5.80	6.00	6.10
D	5.00	5.20	5.40
D2	4.15		4.45
D3	4.05	4.20	4.35
D4	4.80	5.00	5.10
D5	0.25	0.40	0.55
D6	0.15	0.30	0.45
e		1.27	
E	6.20	6.40	6.60
E2	3.50		3.70
E3	2.35		2.55
E4	0.40		0.60
E5	0.08		0.28
E6	0.20	0.325	0.45
E7	0.85	1.00	1.15
E9	4.00	4.20	4.40
E10	3.55	3.70	3.85
K	1.05		1.35
L	0.90	1.00	1.10
L1	0.175	0.275	0.375
θ	0°		12°

Figure 20: PowerFLAT™ 5x6 recommended footprint (dimensions are in mm)



### 4.2 PowerFLAT™ 5x6 WF packing information

Figure 21: PowerFLAT™ 5x6 WF tape (dimensions are in mm)

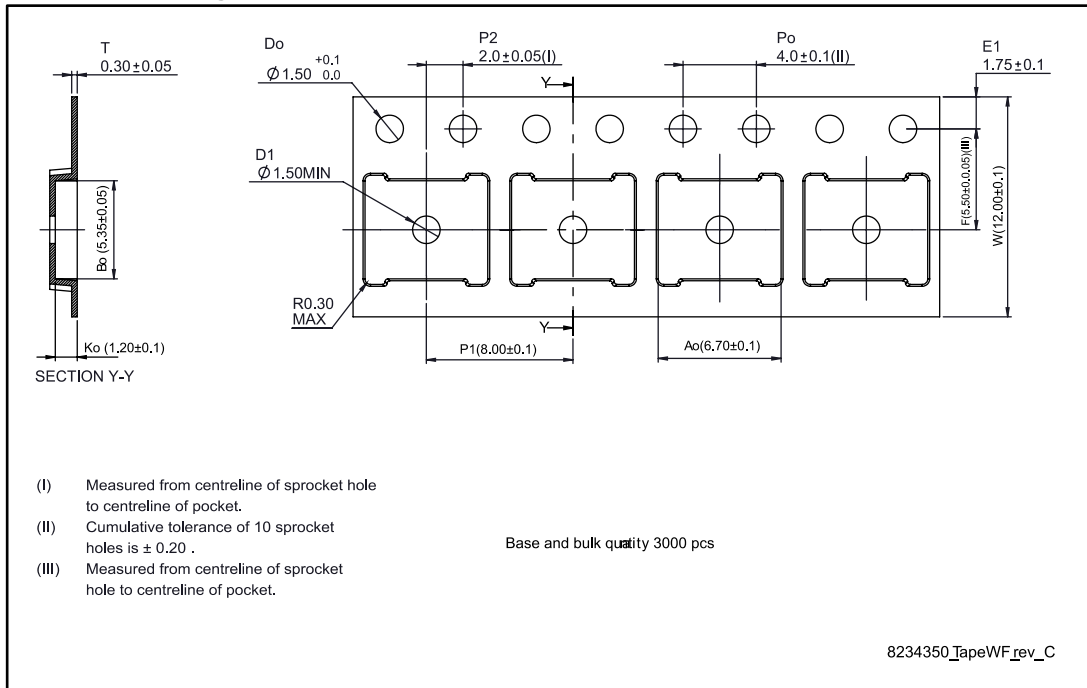

Figure 22: PowerFLAT™ 5x6 package orientation in carrier tape

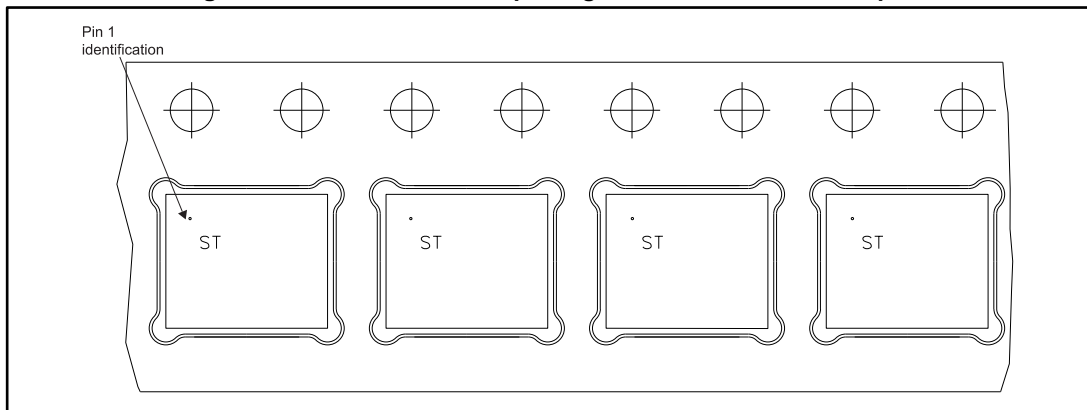
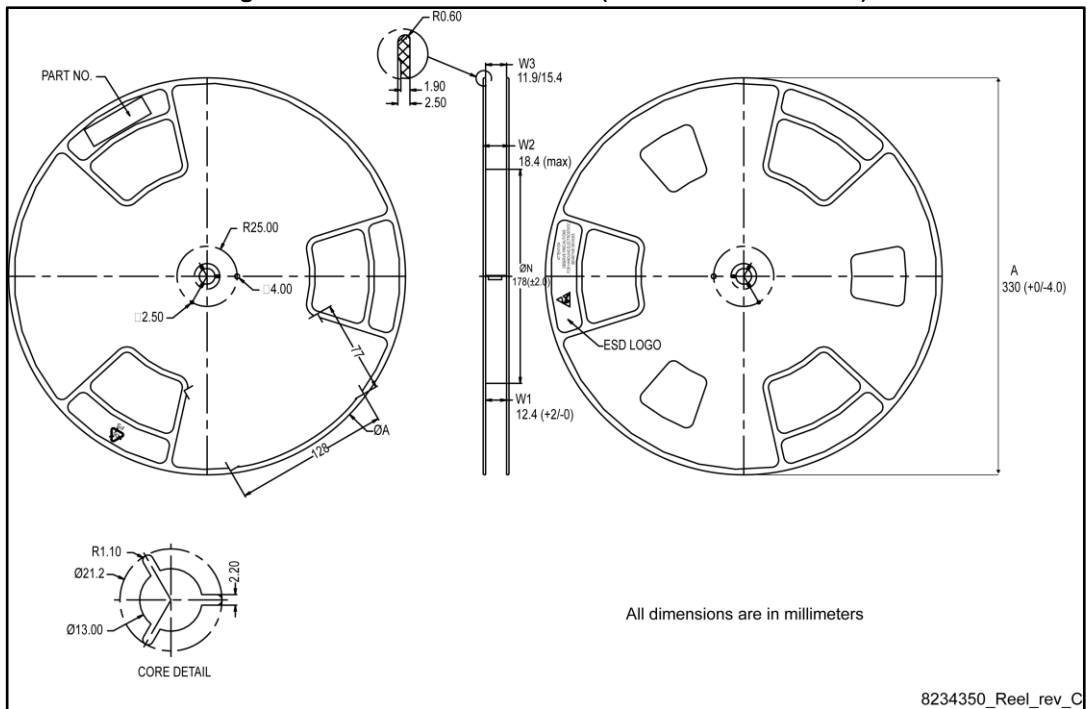

Figure 23: PowerFLAT™ 5x6 reel (dimensions are in mm)



## 5 Revision history

**Table 9: Document revision history**

Date	Revision	Changes
07-Sep-2015	1	First release.
15-Sep-2015	2	Minor text edits. On cover page: - updated Title and Features.
26-Jan-2016	3	Updated <i>Table 2: "Absolute maximum ratings"</i> and <i>Section 4.1: "PowerFLAT™ 5x6 WF type C package information"</i> .
16-Sep-2016	4	Updated the silhouette, the title and the features in cover page. Updated <i>Table 2: "Absolute maximum ratings"</i> , <i>Figure 2: "Safe operating area"</i> and <i>Figure 3: "Thermal impedance"</i> . Minor text changes.

**IMPORTANT NOTICE – PLEASE READ CAREFULLY**

STMicroelectronics NV and its subsidiaries ("ST") reserve the right to make changes, corrections, enhancements, modifications, and improvements to ST products and/or to this document at any time without notice. Purchasers should obtain the latest relevant information on ST products before placing orders. ST products are sold pursuant to ST's terms and conditions of sale in place at the time of order acknowledgement.

Purchasers are solely responsible for the choice, selection, and use of ST products and ST assumes no liability for application assistance or the design of Purchasers' products.

No license, express or implied, to any intellectual property right is granted by ST herein.

Resale of ST products with provisions different from the information set forth herein shall void any warranty granted by ST for such product.

ST and the ST logo are trademarks of ST. All other product or service names are the property of their respective owners.

Information in this document supersedes and replaces information previously supplied in any prior versions of this document.

© 2016 STMicroelectronics – All rights reserved