

SF2120C

149.00 MHz SAW Filter

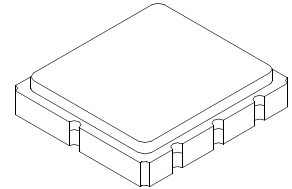

SM5050-8

- **Designed for Broadband Receiver IF Applications**
- **Low Insertion Loss**
- **5.0 X 5.0 mm Surface-mount Case**
- **Differential Input and Single-ended Output**
- **Complies with Directive 2002/95/EC (RoHS)**



Absolute Maximum Ratings

Rating	Value	Units
Maximum Incident Power in Passband	+10	dBm
Maximum DC Voltage on any Non-ground Terminal	3	VDC
Storage Temperature Range in Tape and Reel	-40 to +85	°C
Suitable for Lead-free Soldering - Maximum Soldering Profile	260 °C for 30 s	

Electrical Characteristics

Characteristic	Sym	Min	Typ	Max	Units
Nominal Center Frequency	f_C		149.00		MHz
Insertion Loss			2.0	2.5	dB
2 dB Passband		148 to 150	147.65 to 150.35		MHz
Amplitude Ripple, 148 to 150 MHz, -27.5 to 72.5 °C			1.5	1.8	dB _{P-P}
Amplitude Ripple, 148 to 150 MHz, -40 to -27.5 °C, 72.5 to 85 °C			2.0	2.2	dB _{P-P}
Rejection, f_C -2.5 MHz		15	54		dB
Rejection, f_C +2.5 MHz		15	30		dB
Center Frequency Temperature Coefficient			-30		ppm/K
Operating Temperature		-40		85	°C
Case Style		SM5050-8 5 x 5 mm Nominal Footprint			
Lid Symbolization (Y=year, WW=week, S=shift)		RFM 635 YWWS			

Electrical Connections - Differential Operation

Connection	Terminals
Port 1 Differential Input	1, 2
Port 2 Output	5
Ground	All others

Dot indicates Pin 1

Electrical Connections - Single End Operation

Connection	Terminals
Port 1 Input	1
Port 2 Output	5
Ground	All others

Dot indicates Pin 1

 **CAUTION: Electrostatic Sensitive Device. Observe precautions for handling.**

NOTES:

1. Unless noted otherwise, all specifications apply over the operating temperature range with filter soldered to the specified demonstration board with impedance matching to 50 Ω and measured with 50 Ω network analyzer.
2. Rejection is measured as attenuation below the minimum IL point in the passband. Rejection in final user application is dependent on PCB layout and external impedance matching design. See Application Note No. 42 for details.
3. The design, manufacturing process, and specifications of this filter are subject to change.
4. Tape and Reel Standard ANSI / EIA 481.
5. US and international patents may apply.
6. Murata, stylized Murata logo, and Murata N.A., Inc. are registered trademarks of Murata Manufacturing Co., Ltd.
7. The center frequency will move with ambient temperature changes.

2 dB BW

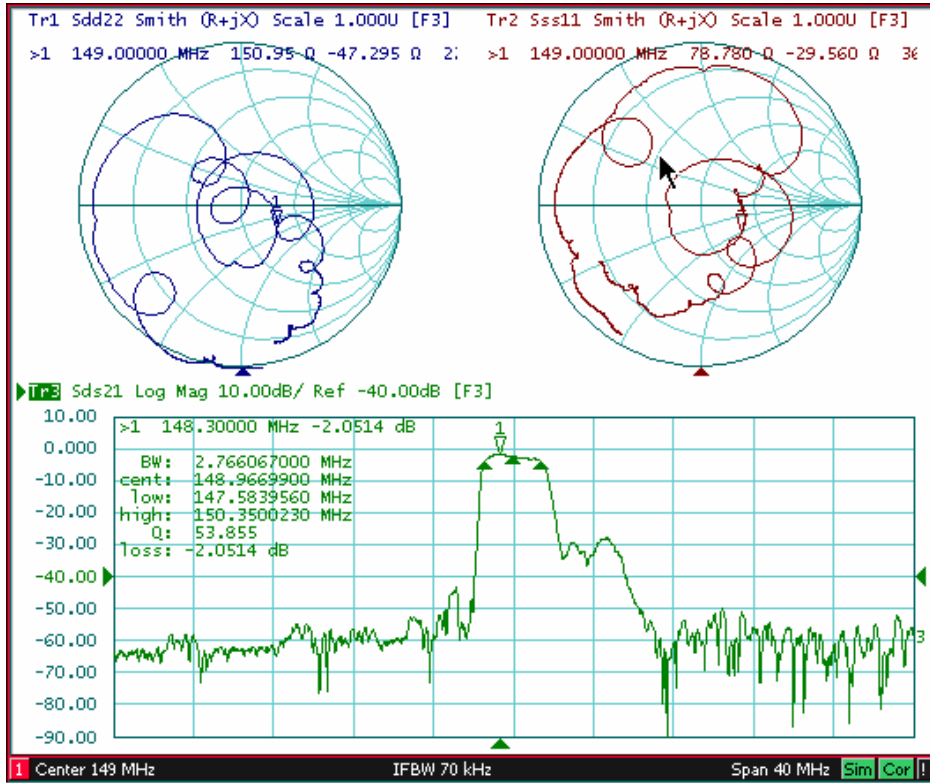

3 dB BW

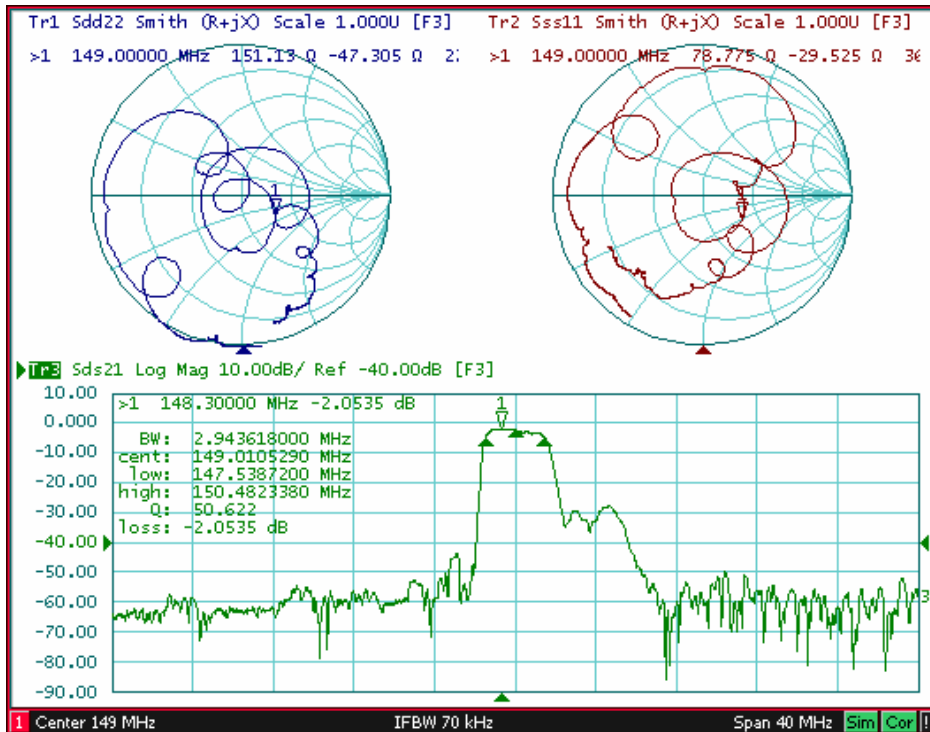

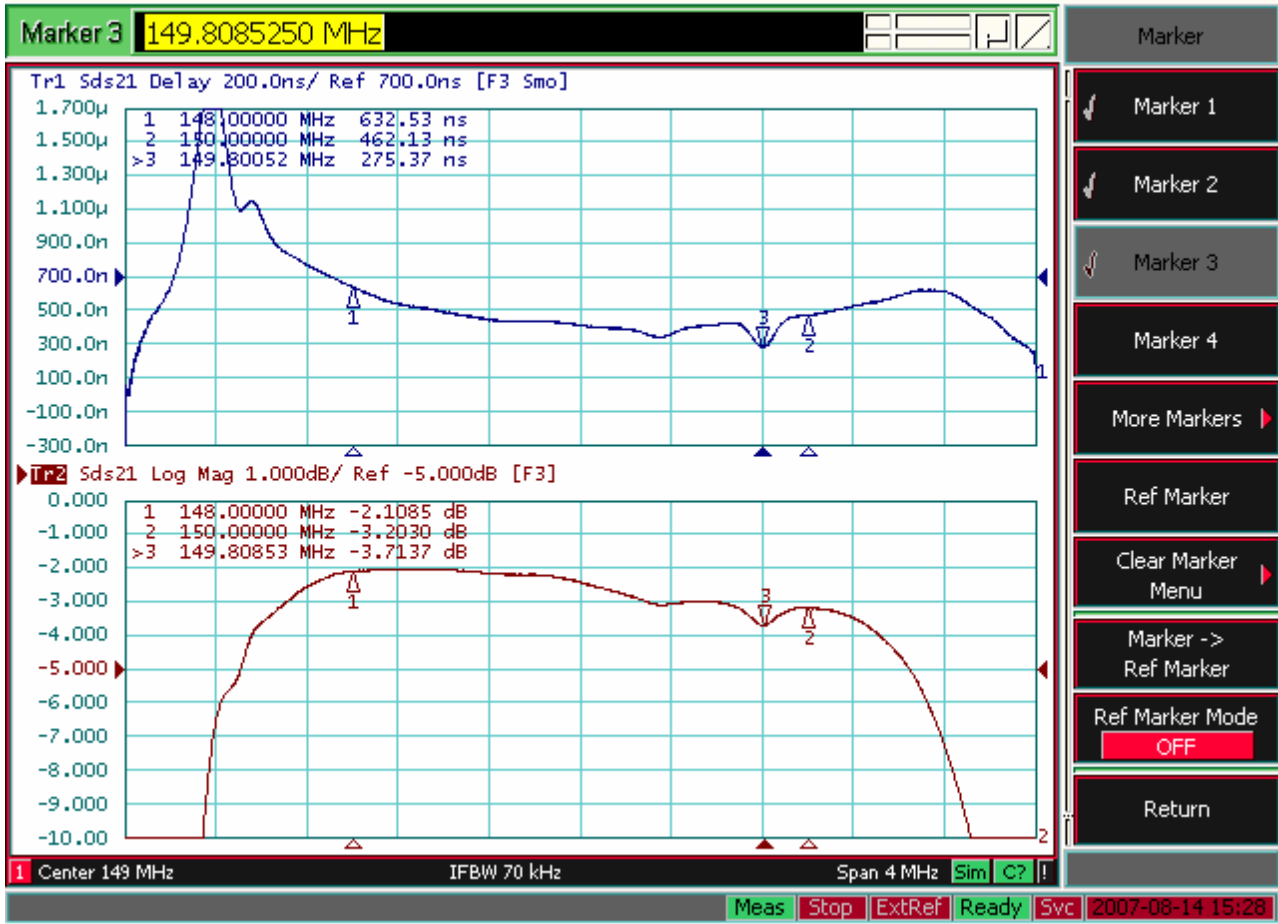

Electrical Connections

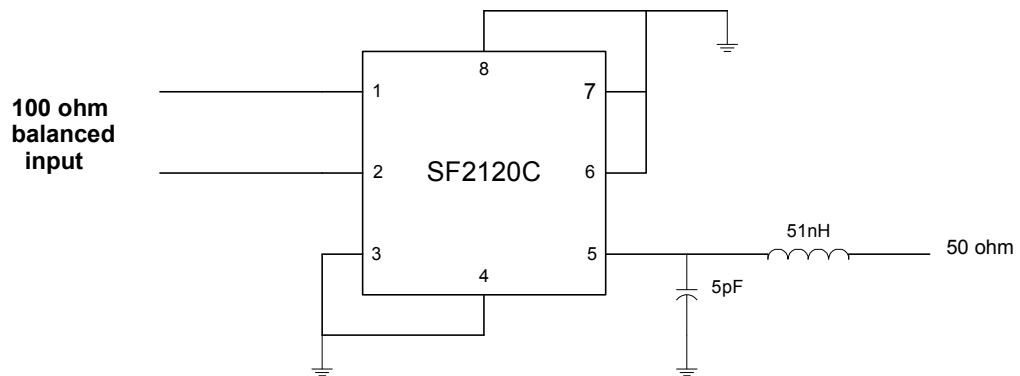

12 Jul 2007 09:02:21

CH1 S11 1 UFS
1: 67.484 Ω -46.605 Ω 22.919 pF
149.000 000 MHz

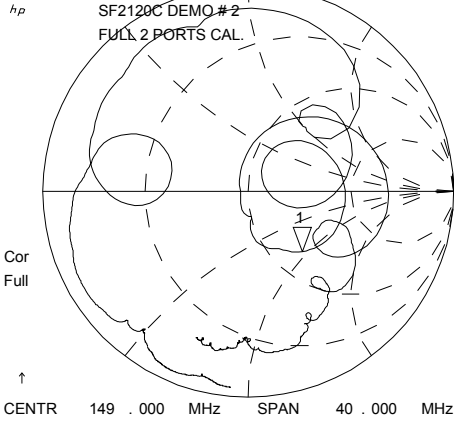

CH3 S22 1 UFS
1: 79.445 Ω -47.031 Ω 22.712 pF
149.000 000 MHz

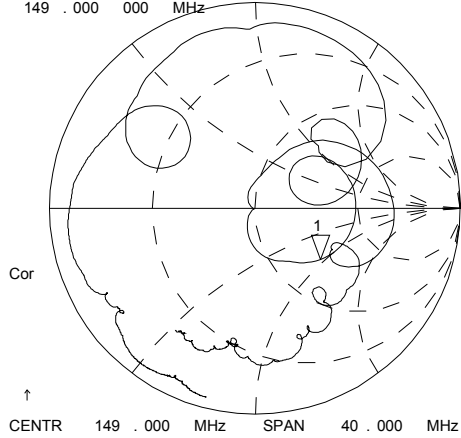

CH2 S21 LOG 10 dB/ REF -2.43 dB 1: -2.8632 dB 149.000 000 MHz

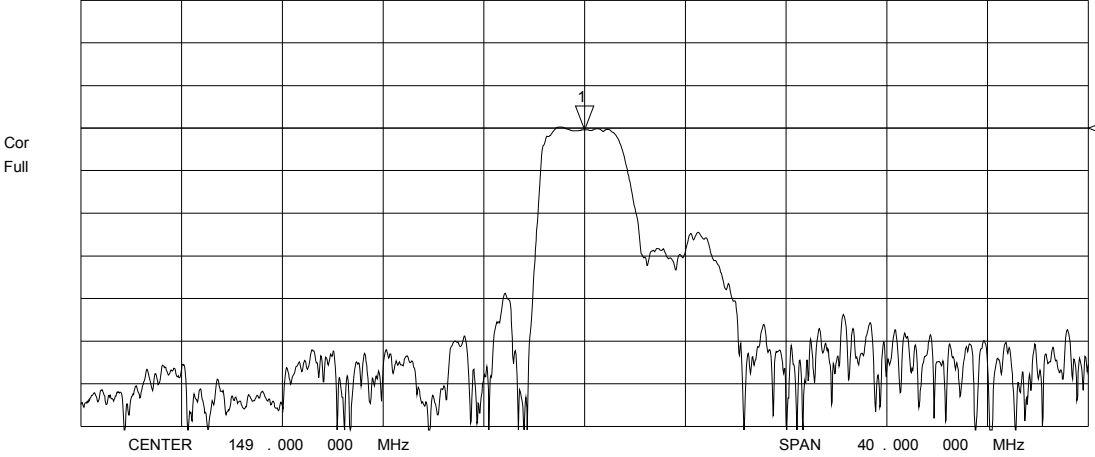

12 Jul 2007 08:52:09

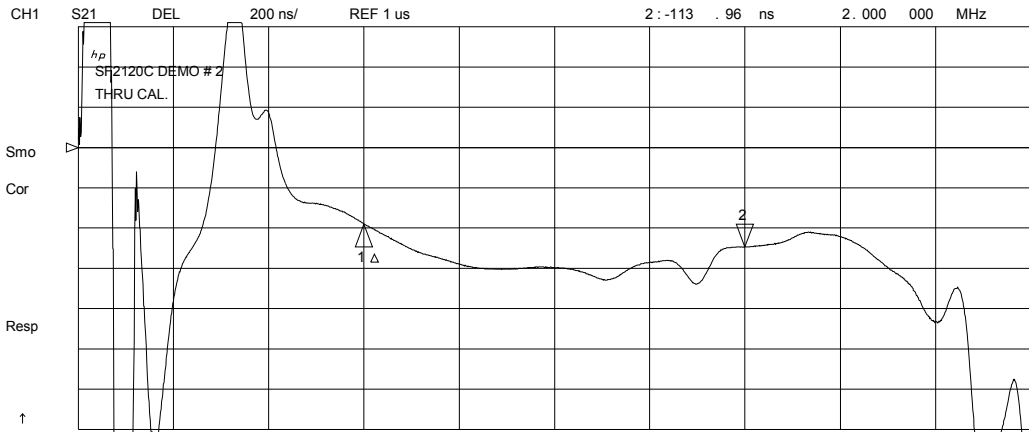

CH1 Markers
 Δ REF=1
 mean : 431 . 85 ns
 s. dev : 63 . 986 ns
 p-p : 298 . 60 ns

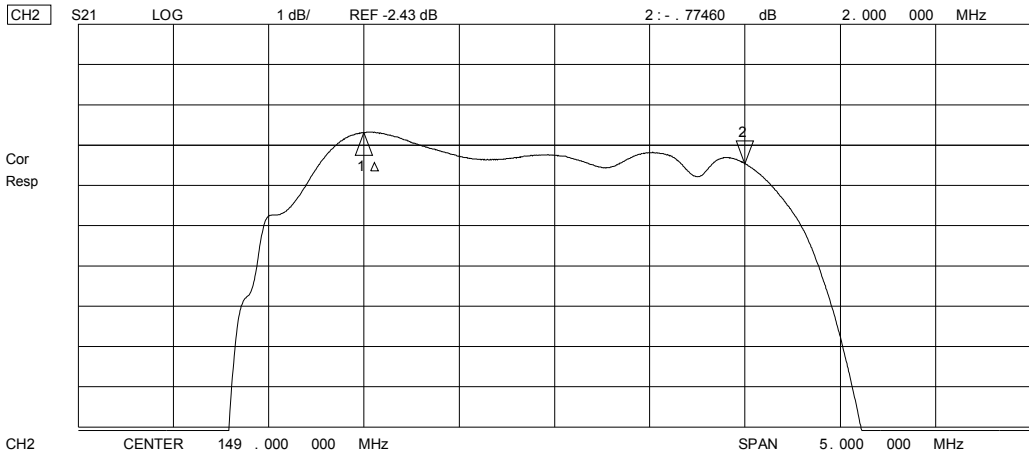

CH2 Markers
 Δ REF=1
 mean : -2 . 6956 dB
 s. dev : . 24420 dB
 p-p : 1 . 1153 dB

CH2 CENTER 149 . 000 000 MHz SPAN 5. 000 000 MHz

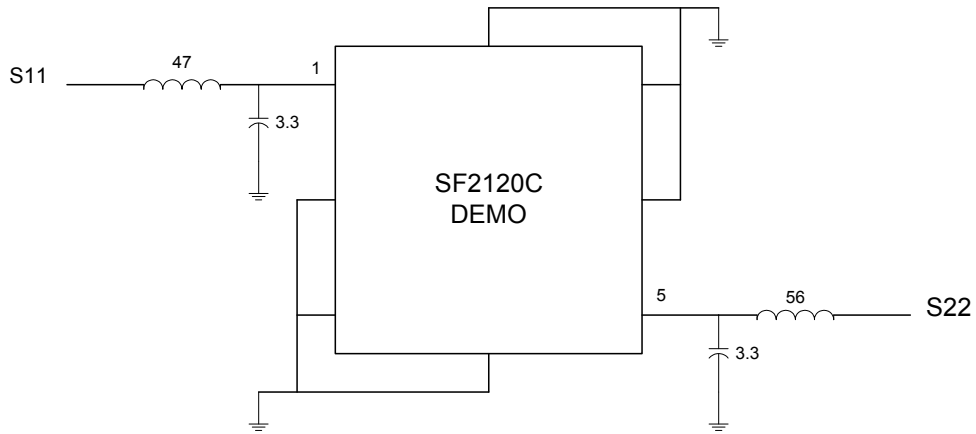

- | | | |
|--------------|-------------|--------|
| 401-1624-001 | | |
| 501-0782-470 | 0805, 47NH | L1 |
| 501-0782-560 | 0805, 56NH | L2 |
| 501-0621-033 | 0603, 3.3PF | C1, C2 |

SM5050-8 Surface-Mount 8-Terminal Ceramic Case

5.0 X 5.0 mm Nominal Footprint

Case Dimensions

Dimension	mm			Inches		
	Min	Nom	Max	Min	Nom	Max
A	4.80	5.00	5.20	0.189	0.197	0.205
B	4.80	5.00	5.20	0.189	0.197	0.205
C	1.30	1.50	1.70	0.050	0.060	0.067
D	1.98	2.08	2.18	0.078	0.082	0.086
E	1.07	1.17	1.27	0.042	0.046	0.050
F	0.50	0.64	0.70	0.020	0.025	0.028
G	2.39	2.54	2.69	0.094	0.100	0.106
H		1.27			0.050	
I		0.76			0.030	
J		1.55			0.061	
K		2.79			0.110	
L		0.76			0.030	
M		2.36			0.093	
N		1.55			0.061	
O		2.79			0.110	
P		2.79			0.110	
Q		2.79			0.110	

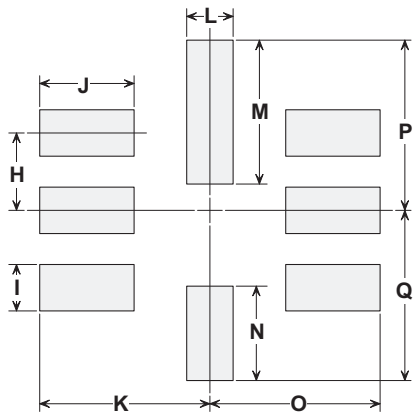
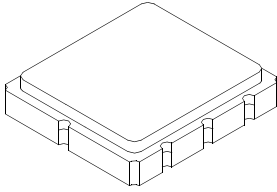

PCB Footprint

Case Materials

Materials	
Solder Pad Plating	0.3 to 1.0 μm Gold over 1.27 to 8.89 μm Nickel
Lid Plating	2.0 to 3.0 μm Nickel
Body	Al_2O_3 Ceramic
	Pb Free

TOP VIEW

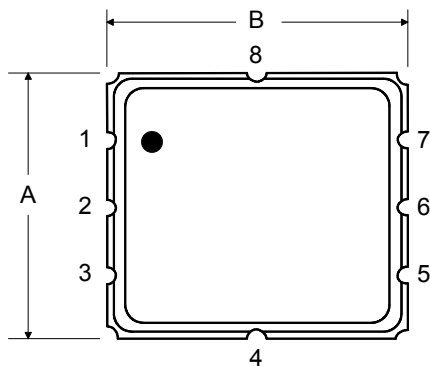

BOTTOM VIEW

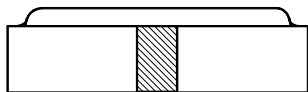
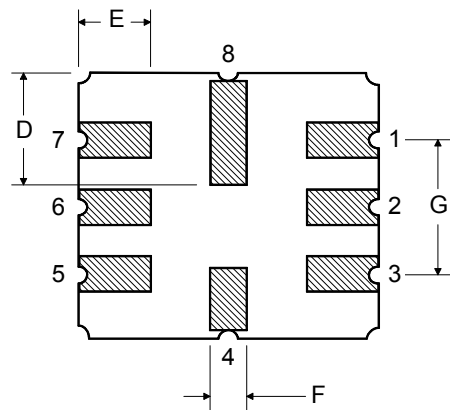

Tape and Reel Specifications

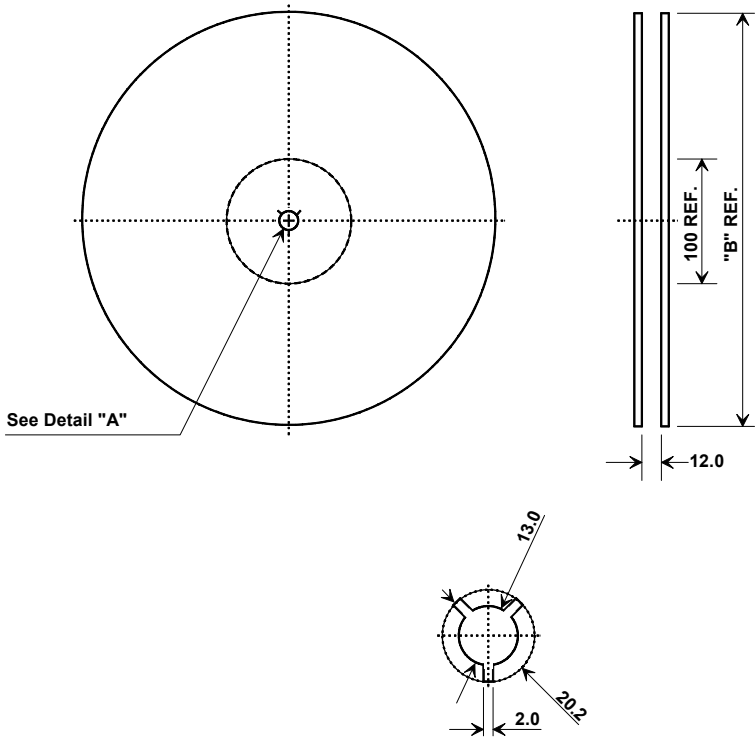

"B" Nominal Size		Quantity Per Reel
Inches	millimeters	
7	178	500
13	330	3000

COMPONENT ORIENTATION and DIMENSIONS

Carrier Tape Dimensions	
Ao	5.3 mm
Bo	5.3 mm
Ko	2.0 mm
Pitch	8.0 mm
W	12.0 mm

