

LUXEON Q

Assembly and handling information

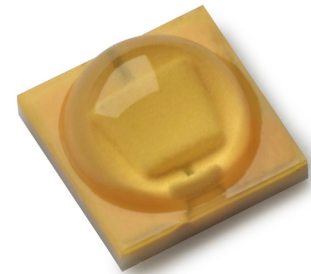

Introduction

This application brief addresses the recommended assembly and handling procedures for LUXEON Q emitters. Proper assembly, handling, and thermal management, as outlined in this application brief, ensure high optical output and long lumen maintenance for both LUXEON emitters.

Scope

The assembly and handling guidelines in this application brief apply to the following LUXEON products:

L1Q0-XXYY0000ZZZ0	
Where:	
xx -	designates nominal ANSI CCT (27 for 2700K, 30 for 3000K)
yy -	designates minimum CRI performance (70 for 70CRI, 80 for 80CRI)
zzz -	designates minimum flux performance at standard binning current and temperature (e.g., 090 for 90 lumens, 110 for 110 lumens, etc). 000 designates full distribution flux performance.

In the remainder of this document the term LUXEON emitter refers to the LUXEON product series listed above. Any handling requirements that are specific to a subset of LUXEON emitters will be clearly marked.

Table of Contents

Introduction	1
Scope	1
1. Component	3
1.1 Description	3
1.2 Optical Center	3
1.3 Handling Precautions	4
1.4 Cleaning	4
1.5 Electrical Isolation	4
1.6 Mechanical Files	4
1.7 Packing and Storage	4
1.8 Soldering	5
2. LUXEON Printed Circuit Board Design Rules	5
2.1 LUXEON Footprint and Land Pattern	5
2.2 Surface Finishing	5
2.3 Minimum Spacing	5
3. Thermal Management	6
3.1 FR4-Based Star Board Study	6
3.2 FR4-Based Star Board Result and Discussion	7
3.3 MCPCB Based Star Board	9
4. Thermal Measurement Guidelines	10
5. Solder Reflow Guidelines	11
5.1 Stencil and Solder Paste	11
5.2 Solder Paste Screen Printing	11
5.3 Solder Reflow Profile	11
5.4 Placement Accuracy	11
6. Pick-and-Place Process Guidelines	12
6.1 Pick-and-Place Nozzles and Machines Settings	12
6.2 Pick-and-Place Machine Optimization	14
7. Packaging Considerations — Chemical Compatibility	18
About Lumileds	20

1. Component

1.1 Description

The LUXEON Q emitter consists of an LED chip mounted onto a ceramic substrate. The ceramic substrate provides mechanical support and thermally connects the LED chip to a thermal pad on the bottom of the substrate. An electrical interconnect layer connects the LED chip to a cathode and anode on the bottom of the ceramic substrate. A transient voltage suppressor (TVS) chip is connected in parallel to the LED chip to provide ESD protection. A silicone dome is formed over the LED chip to enhance light extraction and to shield the chip from the environment.

The bottom of the LUXEON emitter (Figure 1) contains three silver plated metallization pads: a large thermal pad in the center, an anode with marking, and a cathode.

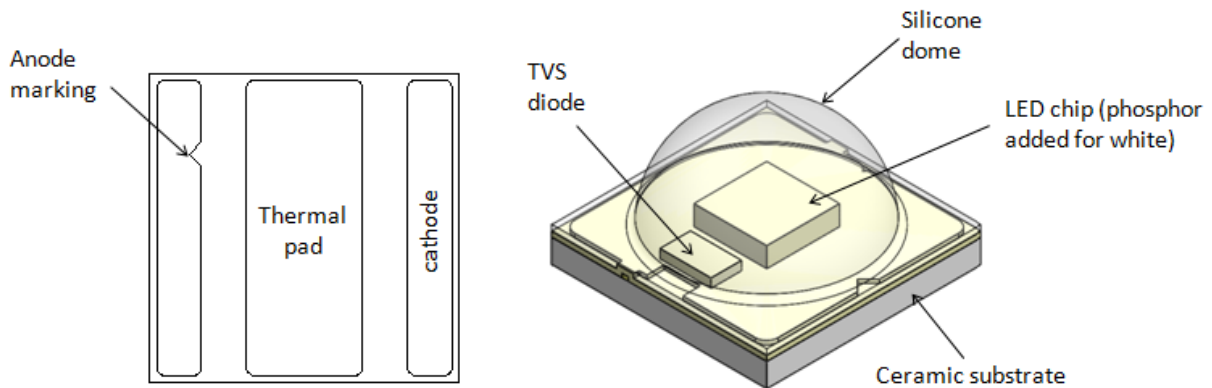

Figure 1. Bottom view (left) and isometric view (right) of the LUXEON emitter.

1.2 Optical Center

The optical center, which happens to be also the package center of LUXEON Q emitter, is located 1.725mm from the edge of the package outline as shown in Figure 2. The LED package outline can be used to locate this optical center.

Optical rayset data for the LUXEON emitter is available on the Lumileds website at lumileds.com.

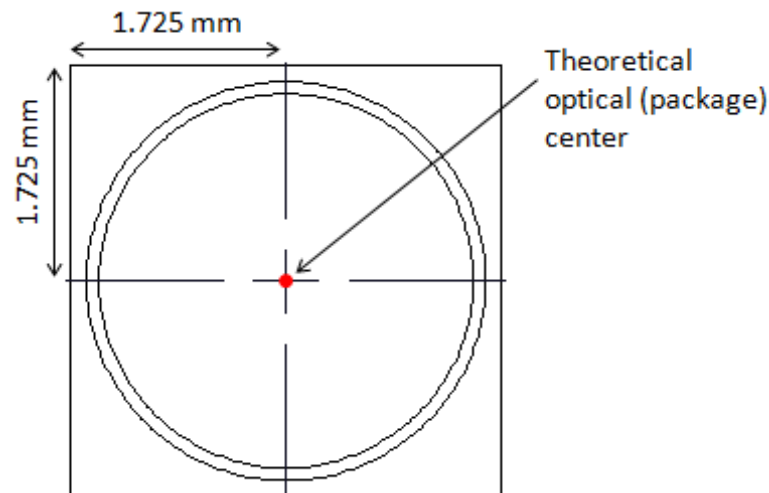

Figure 2. Bottom view (left) and isometric view (right) of the LUXEON emitter.

1.3 Handling Precautions

The LUXEON emitter is designed to maximize light output and reliability. However, improper handling of the emitter may damage the silicone dome and affect the overall performance and reliability. In order to minimize the risk of damage to the silicone dome during handling, LUXEON emitters should only be picked up from the side of the ceramic frame as shown in Figure 3.



Figure 3. Correct handling (left) and incorrect handling (middle and right) of LUXEON Q emitters.

1.4 Cleaning

A LUXEON emitter should not be exposed to dust or debris. Excessive dust or debris may cause a drastic decrease in optical output. In the event that a LUXEON emitter requires cleaning, first try a gentle swabbing using a lint-free swab. If needed, a lint-free swab and isopropyl alcohol (IPA) can be used to gently remove dirt from the silicone. Do not use other solvents as they may adversely react with the LED assembly.

1.5 Electrical Isolation

The thermal pad of the LUXEON emitter is electrically isolated from its cathode and anode. Consequently, a high voltage difference between electrical and thermal metallization may occur in applications where multiple emitters are connected in series. As a reference, the nominal distance between the electrical metallization and the thermal metallization of the LUXEON emitter is 0.25mm.

In order to avoid any electrical shocks and/or damage to the LUXEON emitter, each design needs to comply with the appropriate standards of safety and isolation distances, known as clearance and creepage distances, respectively (e.g. IEC60950, clause 2.10.4).

1.6 Mechanical Files

Mechanical drawings for LUXEON are available on the Lumileds website at lumileds.com.

1.7 Packing and Storage

Since LUXEON Q metallization pads are silver plated, they are susceptible to corrosion. During assembly, the parts should be handled in a non-corrosive environment. Any unused parts must be secured in the original LUXEON Q packing bag immediately after use without adding any items such as rubber bands, adhesive labels/tapes and other desiccants not originally shipped with the packing bag. These items may contain sulfur which can cause the silver to tarnish and prevent good wetting during soldering process.

The surrounding air where the packing bag (if not air-tight sealed) is stored must be free of chlorides and sulfides. Exposing the packing bags to outside air, for example may introduce sulfur from fossil burning. Packing bags that are already opened should preferably be kept in a nitrogen filled desiccator. The recommended storage condition is temperature of less than 30°C and 75% relative humidity.

1.8 Soldering

LUXEON emitters are designed to be soldered onto a Printed Circuit Board (PCB). For detailed assembly instructions, see Section 2.

2. LUXEON Printed Circuit Board Design Rules

The LUXEON emitter is designed to be soldered onto a PCB. To ensure optimal operation of the LUXEON emitter, the PCB should be designed to minimize the overall thermal resistance between the LED package and the heat sink.

2.1 LUXEON Footprint and Land Pattern

The LUXEON emitter has three pads that need to be soldered onto corresponding pads on the PCB to ensure proper thermal and electrical operation. Figure 4 shows the recommended PCB footprint design for the LUXEON emitter. Heat spreading into the PCB is improved by extending the thermal pad and electrodes on the PCB beyond the package outline of the LUXEON emitter. Thermal simulations indicate that heat spreading is maximized if the thermal pad and electrodes are extended 3mm from the center of the LUXEON emitter.

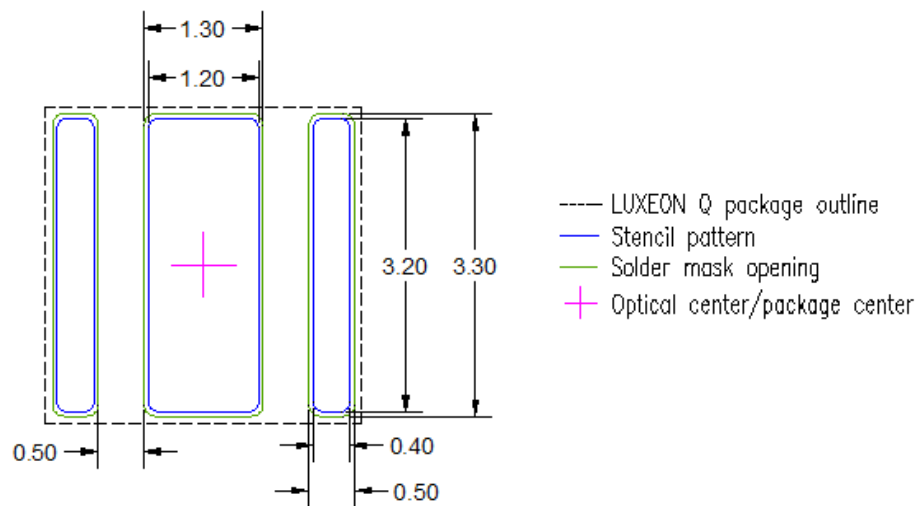

Figure 4. Recommended LUXEON Q PCB footprint layout showing the solder mask and stencil pattern.

2.2 Surface Finishing

Lumileds recommends using a high temperature organic solderability preservative (OSP) on the copper layer.

2.3 Minimum Spacing

Lumileds recommends a minimum edge to edge spacing between LUXEON emitters of 0.3mm to minimize the chance of mechanical interference between neighboring units during pick and place. Note that placing multiple LUXEON emitters in close proximity to each other on a PCB may adversely impact the ability of the PCB to dissipate the heat from the emitters. Also, the light output for each LED may drop due to optical absorption by adjacent LED packages.

3. Thermal Management

The overall thermal resistance between a LUXEON emitter and the heat sink is strongly affected by the design and material of the PCB on which the LUXEON emitter is soldered. Metal Core PCBs have been historically used in the LED industry for their low thermal resistance and rigidity. However, MCPCBs may not always offer the most economical solution.

Multi-layer epoxy FR4 PCBs are commonly used in the electronics industry and can, in certain LED applications, yield a lower cost solution. However, given the poor thermal conductivity of the epoxy in FR4 PCBs, it is important to include special thermal vias in the PCB design to aid the transport of heat from the LED to the heat sink on which the PCB is mounted. A thermal via is a plated through hole that can be open, plugged, filled or filled and capped. Open vias are typically placed outside the pads on which the LEDs are soldered to prevent any solder from reaching the other side of the PCB during reflow. A filled-and-capped via, in contrast, can be placed directly underneath the thermal pad of the LED, improving the thermal performance of the PCB.

The thermal resistance of an FR4 PCB depends on several variables including the board thickness, the thickness of the copper plating, the copper trace pattern, and the number and density of thermal vias. For general guidelines on FR4 PCB based designs, please refer to section 3 of Philips Lumileds document AB32 “LUXEON LED Assembly and Handling Information.”

3.1 FR4-Based Star Board Study

Lumileds has investigated the thermal performance of LUXEON emitters on 1.0mm thick FR4 PCB in standard star board with open Plated Through Hole (PTH) vias, as shown in Figure 5. The thickness of the copper plating on the top and bottom of the PCB is 70µm or 2oz thick and the plating inside the thermal vias is 35µm or 1oz thick. Note: copper final thickness may vary depending on PCB manufacturing process.

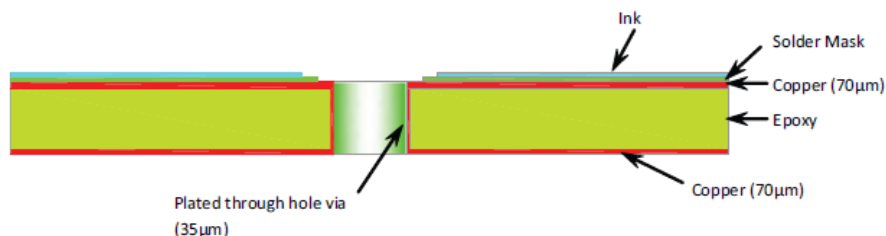
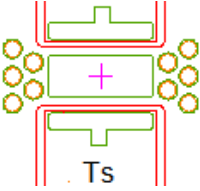
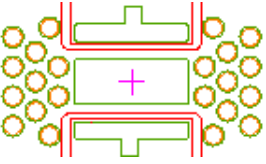
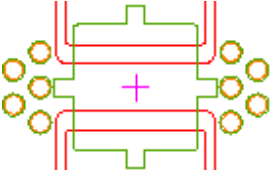
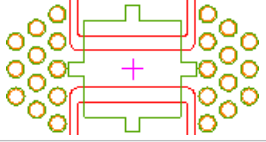
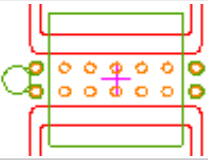
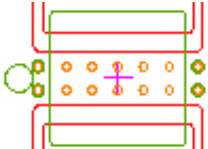

Figure 5. Typical cross section of an FR4 PCB based on an open via PTH design.

There are six different FR4 board configurations that were investigated to illustrate the impact to the FR4 board thermal resistance (as measured from LUXEON Q thermal pad to bottom of FR4 board/heat sink) by varying the positions of the open PTH thermal vias and the number of vias used as shown in Table 1.

Table 1. Typical Thermal Resistance Values (pad to heat sink) for Different FR4 Board Configurations.

CONFIGURATION	BOARD DESIGN	DESCRIPTION	TYPICAL BOARD THERMAL RESISTANCE RESULT 350MA, 25°C
A		10 open PTH vias (0.5mm diameter) with T_s point on the electrode pads.	9.2
B		22 open PTH vias (0.5mm diameter) with T_s point on the electrode pads.	9.2
C		10 open PTH vias (0.5mm diameter) with T_s point on all the thermal and electrode pads. Note: by locating the T_s point near the thermal pad, the vias has to be placed further from this pad.	11.7
D		22 open PTH vias (0.5mm diameter) with T_s point on all the thermal and electrode pads.	11.3
E		14 open PTH vias (0.25mm diameter) with 10 vias within the LUXEON Q thermal pad.	6.2
F		14 open PTH vias (0.20mm diameter) with 10 vias within the LUXEON Q thermal pad.	7.0

3.2 FR4-Based Star Board Result and Discussion

Below are the FR4 board thermal resistance conclusions that can be derived from this study:

- Adding more open PTH vias does not significantly reduce the FR4 board thermal resistance (see configuration A–B and C–D) but may increase PCB manufacturing cost
- By placing the open PTH vias further away from the thermal pad and increasing the via to via distance, the FR4 board thermal resistance will increase (see configuration A–C and B–D)
- By putting open PTH vias within the thermal pad will significantly reduce the FR4 board thermal resistance (see configuration E–F versus A, B, C or D)
- By increasing the via diameter (0.25mm versus 0.20mm) for configuration E and F will reduce the FR4 board thermal resistance.

Even though configuration E and F have the best thermal resistances, there is some difficulty in controlling and preventing solder from being wicked out through the open PTH vias underneath the LUXEON emitter thermal pad area as shown in Figure 6. Solder wicking may increase solder void area and/or create uneven back contact surface of the FR4 board. Filled and capped vias can help to resolve this but at a much higher PCB manufacturing cost as described in AB32 "LUXEON LED Assembly and Handling Information."

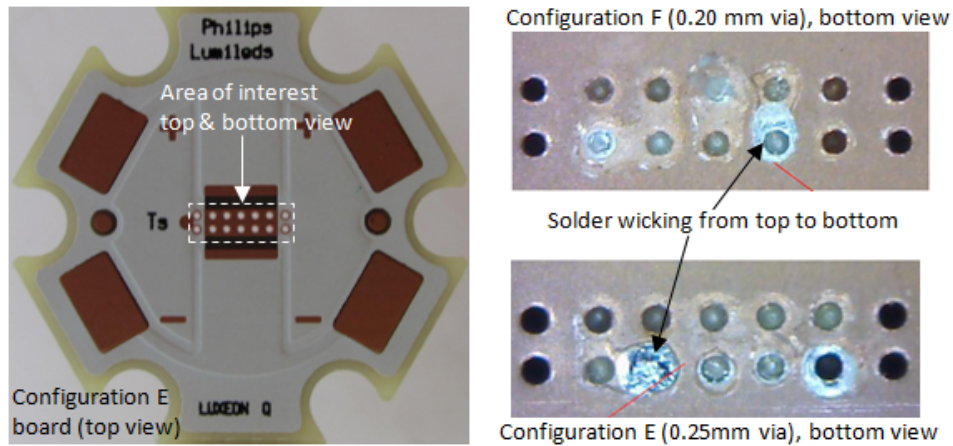

Figure 6. Solder wicking through open PTH vias in the thermal pad area.

Based on current available data, design configuration A with 10 vias for FR4 board will be sufficient for most applications. Detailed via information for this design is summarized in Figure 7.

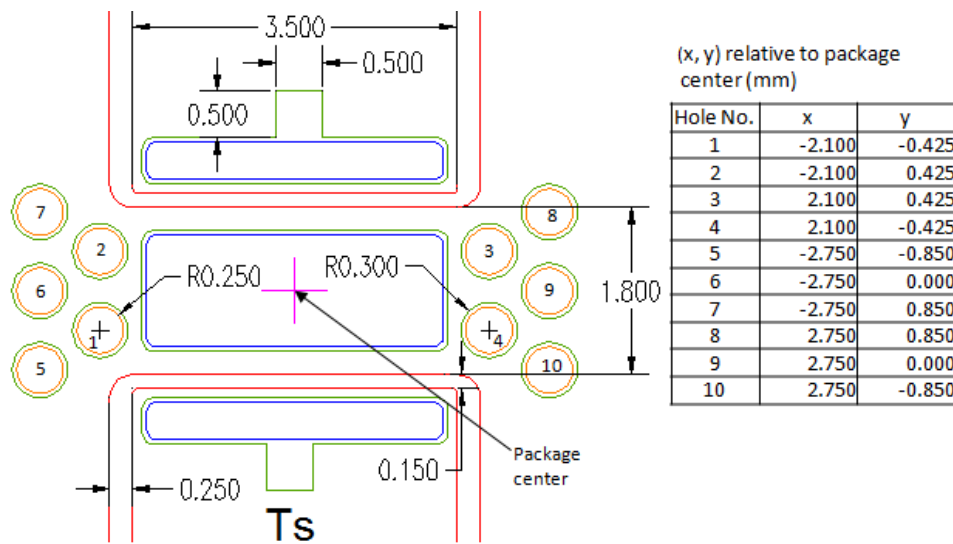

Figure 7. FR4 open PTH layout for configuration A with via position relative to package center.

3.3 MCPCB Based Star Board

The footprint layout in Figure 4 is suitable for MCPBC substrates. In order to minimize the thermal resistance between junction and bottom of the PCB, the copper area connected to the thermal pad and electrodes must be maximized. Lumileds recommends extending the copper area for the thermal pad and electrodes at least 3mm beyond the outline of the LUXEON emitter. Figure 8 shows a typical MCPCB cross section.

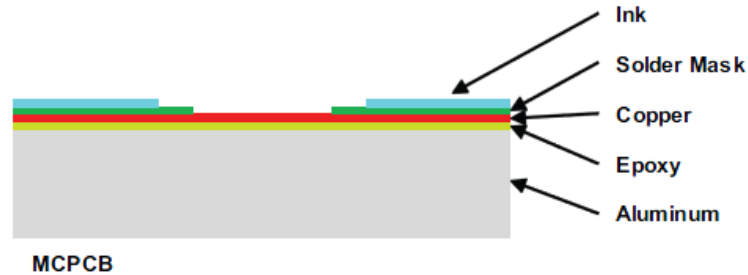

Figure 8. Cross section of MCPCB.

The overall thermal resistance of MCPCB depends on several key factors, including:

- Copper layer thickness (in oz such as 1oz versus 2oz copper, thicker copper is preferred)
- Epoxy dielectric thermal conductivity (in $Wm^{-1}K^{-1}$, a higher value is better)
- Epoxy dielectric thickness (in μm , a lower value is, generally speaking better; note though that the epoxy thickness will impact the PCB dielectric breakdown voltage. If needed, the dielectric breakdown voltage must comply to UL, IEC or any applicable standards in each region or national standards)
- Aluminum board thickness (in mm, a thinner board is better but may affect the mechanical strength)
- LED emitter spacing. Smaller spacing increases thermal crowding, resulting in higher thermal resistance values.

A properly designed MCPCB can yield a thermal resistance between pad and heat sink well below 3K/W.

4. Thermal Measurement Guidelines

This section provides general guidelines on how to determine the junction temperature of a single standalone LUXEON emitter. These guidelines can be used to verify that the junction temperature in the actual application during regular operation does not exceed the maximum allowable temperature specified in the datasheet.

The typical thermal resistance $R\theta_{j\text{-thermal pad}}$ between the junction and thermal pad for a LUXEON emitter is specified in the datasheet. With this information, the junction temperature T_j can be determined according to the following equation:

$$T_j = T_{\text{thermal pad}} + R\theta_{j\text{-thermal pad}} \cdot P_{\text{electrical}}$$

In this equation $T_{\text{thermal pad}}$ is the temperature at the bottom of the LUXEON thermal pad and $P_{\text{electrical}}$ is the electrical power going into the LUXEON emitter.

In typical applications it may be difficult, though, to measure the thermal pad temperature $T_{\text{thermal pad}}$ directly. Therefore, a practical way to determine the junction temperature for the LUXEON emitter is by measuring the temperature T_s of a predetermined sensor pad on the PCB right next to the LUXEON emitter with a thermocouple. The recommended location of the sensor pad is shown in Figure 9 for configuration A of the FR4 boards which were evaluated. To ensure accurate readings, the thermocouple must make direct contact with the copper of the PCB onto which the thermal pad of the LUXEON emitter is soldered, i.e. any solder mask must first be removed before mounting the thermocouple onto the PCB.

The thermal resistance $R\theta_{j\text{-s}}$ between the sensor pad and the junction of the LUXEON emitter was experimentally determined to be approximately 7K/W for the board configuration in Figure 9. A similar value for $R\theta_{j\text{-s}}$ was recorded on MCPCB substrates where the T_s point was defined in the center of the thermal pad, right next to the ceramic substrate (see design E or F in Table 1, excluding the thermal vias). The junction temperature can then be calculated as follows:

$$T_j = T_s + 7 \cdot P_{\text{electrical}}$$

In this equation $P_{\text{electrical}}$ is the electrical power going into the LUXEON emitter.

For guidelines on how to mount a thermocouple onto a PCB, see section 2 of Lumileds document AB33 "LUXEON Rebel Thermal Measurement Guidelines."

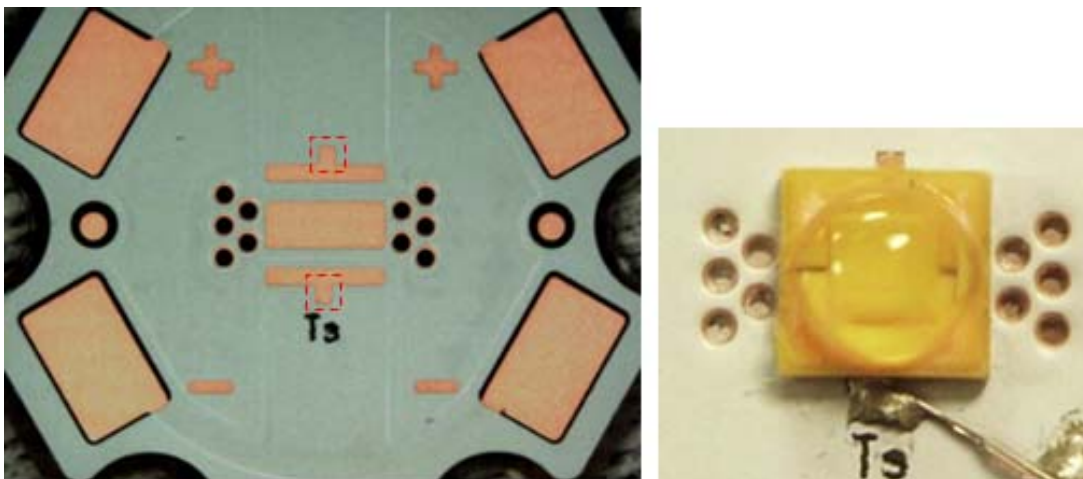

Figure 9. On the left photo, the thermocouple wire can be mounted on any of the two red dotted square areas. Right photo shows one example.

5. Solder Reflow Guidelines

5.1 Stencil and Solder Paste

Using the stencil layout as shown in Figure 4, Lumileds has successfully reflowed the LUXEON emitter on configuration A FR4 board using a 5 mil (125µm) thick stencil using no clean solder paste Alpha® SAC305-CVP390-M20 type 3 with satisfactory results (solder voiding less than 25% per IPC). However, since application environments vary widely, Lumileds recommends that customers perform their own solder paste evaluation in order to ensure it is suitable for the targeted application.

5.2 Solder Paste Screen Printing

In general there are three methods to align the stencil to the PCB during solder paste screen printing:

1. The stencil is manually aligned to the PCB prior to printing. No adjustments are made during printing.
2. The stencil is manually aligned to the PCB prior to printing. During printing, the machine keeps track of the PCB fiducial mark(s) and makes any necessary adjustments to maintain proper alignment with the PCB.
3. A technician performs a crude alignment of the stencil to the PCB. During printing, the machine keeps track of the PCB fiducial mark(s) and the stencil fiducial mark(s) and maintains proper alignment between the fiducials throughout the process.

Method 1 has the worst accuracy and repeatability of the three methods discussed. Method 2 offers the same accuracy as method 1 but ensures better repeatability. Method 3 has the best accuracy and best repeatability of the 3 methods discussed.

In order to ensure proper alignment between the stencil and the PCB as well as reliable transfer of solder paste onto the PCB, all PCB panels should be rigidly supported during solder paste printing. Instead of placing the PCB panel on multiple support pins, it is best to place the PCB panel on a single solid plate. This is particularly important for PCB panels which contain v-scores or perforated holes for de-panel purposes.

5.3 Solder Reflow Profile

The LUXEON emitter is compatible with standard surface-mount and lead-free reflow technologies. This greatly simplifies the manufacturing process by eliminating the need for adhesives and epoxies. The reflow step itself is the most critical step in the reflow soldering process and occurs when the boards move through the oven and the solder paste melts, forming the solder joints. To form good solder joints, the time and temperature profile throughout the reflow process must be well maintained.

A temperature profile consists of three primary phases:

1. Preheat: the board enters the reflow oven and is warmed up to a temperature lower than the melting point of the solder alloy.
2. Reflow: the board is heated to a peak temperature above the melting point of the solder, but below the temperature that would damage the components or the board.
3. Cool down: the board is cooled down, allowing the solder to freeze, before the board exits the oven.

For detailed information on the recommended reflow profile, refer to the IPC/JEDEC J-STD-020C reflow profile in the appropriate datasheet for each LUXEON product.

5.4 Placement Accuracy

Alignment marks on the PCB panel can be used to calculate the reflow accuracy of the LUXEON emitter with respect to its theoretical board position. Lumileds has determined that the typical placement accuracy of a LUXEON emitter after reflow is within 200µm in the x- and y-direction for the footprint in Figure 4.

6. Pick-and-Place Process Guidelines

6.1 Pick-and-Place Nozzles and Machines Settings

Automated pick and place equipment typically provides the best placement accuracy for LEDs. Figure 10 and Figure 11 show two nozzle designs and corresponding machine settings which have been successfully used to pick and place LUXEON emitters with equipment from Yamaha and Juki. Each nozzle is designed to pick the LUXEON emitter up from the flat area around the dome without making contact with the silicone dome itself.

Note that pick and place nozzles are customer specific and are typically machined to fit specific pick and place tools. In this study, Lumileds obtained the nozzle from [Ching Yi Technology](#).

Table 2. LUXEON Q pick and place nozzles from Ching Yi Technology

MACHINE	PART NO.	DRAWING NO.
Yamaha YV100X	YMH-0938/12	11452C
Juki KE2080L	JUK-0917/12	11433D

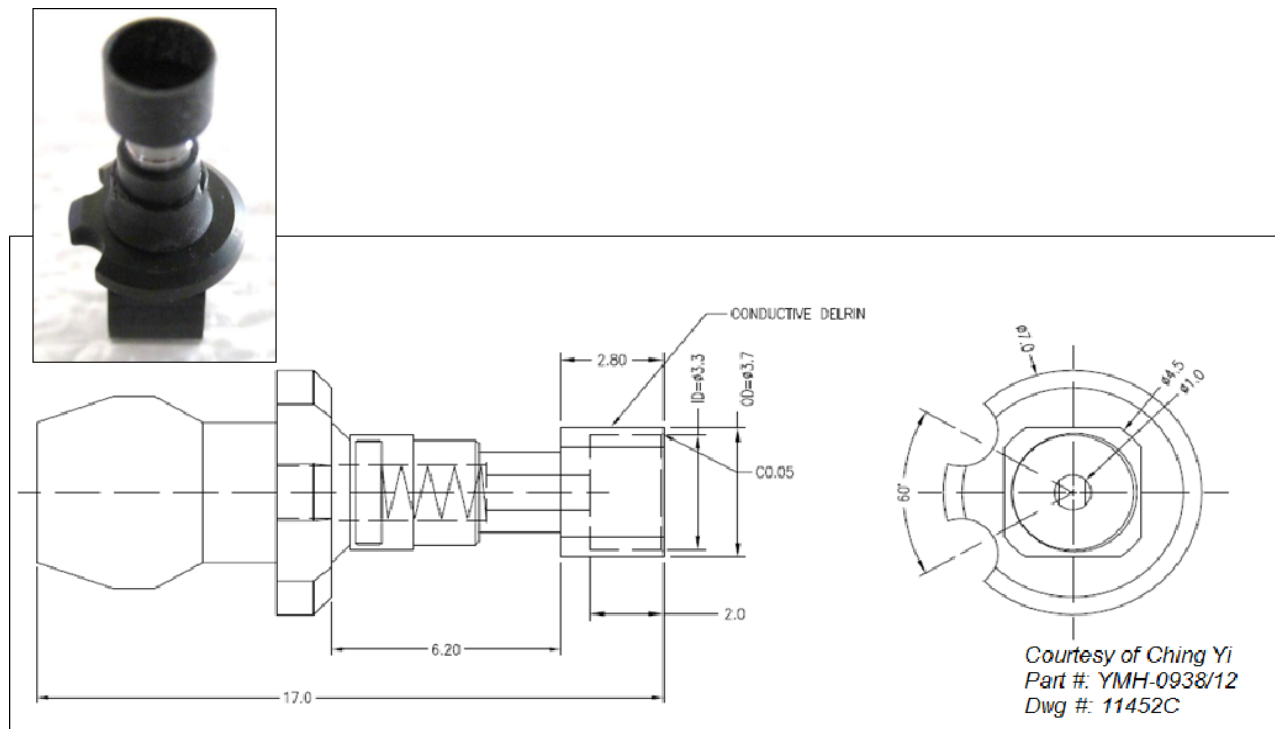

PICK AND MOUNT INFORMATION	
Pick timer	0s
Mount timer	0s
Pick height	0.7mm
Mount height	0mm
Mount action	Normal
Mount speed	100%
Pickup speed	100%
Vacuum check	Normal Chk
Pick vacuum	20%
Mount vacuum	60%

VISION INFORMATION	
Alignment group	Special
Alignment type	Odd. Chip
Alignment module	Fore & Back & Las
Light selection	Main + Coax
Lighting level	6/8
Comp. threshold	100
Comp. tolerance	30
Search area	2.5mm
Comp. intensity	N.A.
Auto threshold	Not Used

Figure 10. Pick and place nozzle design and machine settings for Yamaha YV100X. All dimensions in mm. Nozzle drawing courtesy of Ching Yi Technology Pte Ltd (part #: YMH-0389/12).

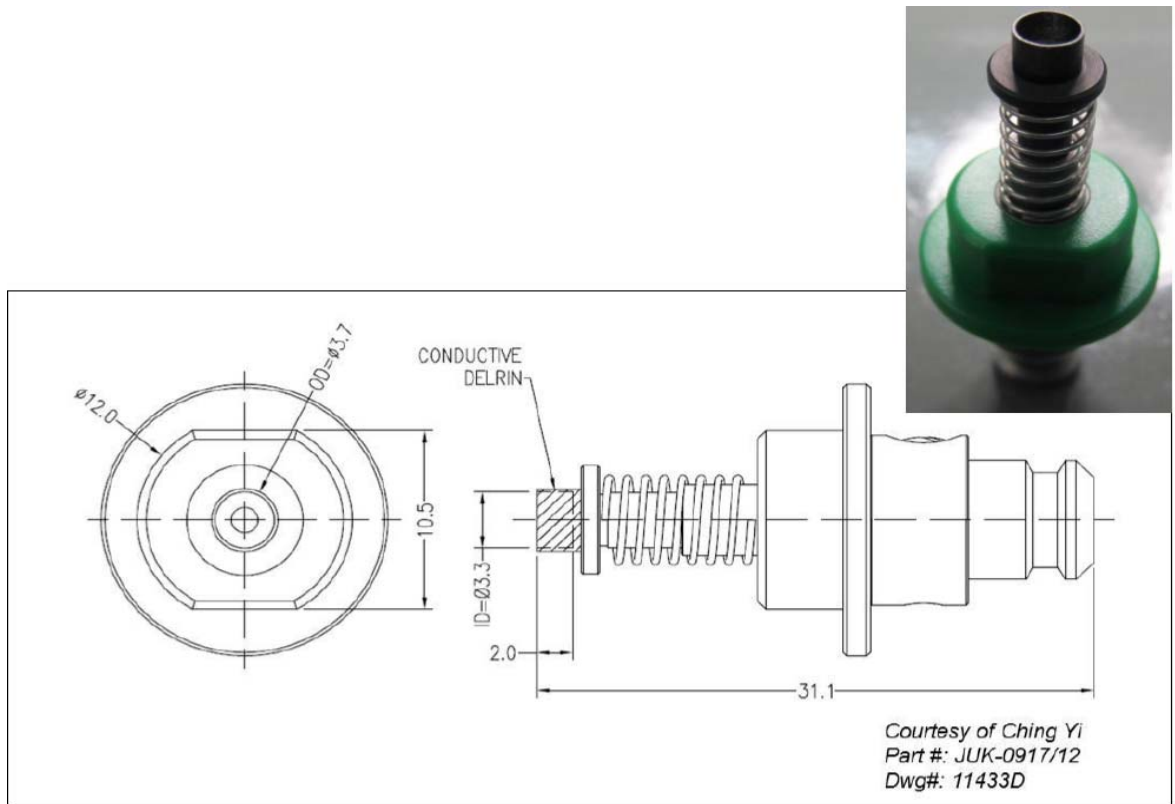

PICK AND MOUNT INFORMATION	
XY	Fast2
Pick depth	0mm
Picking stroke	0mm
Pick Z down	Fast2
Pick Z up	Fast2
Placing stroke	0mm
Place Z down	Fast2
Place Z up	Fast2
Theta (Measure)	Fast
Theta (Other)	Fast

VISION INFORMATION	
Centering method	Laser
LNC 60/61 Laser	-0.59
Comp shape	Corner Square

Figure 11. Pick and place nozzle design and machine settings for Juki KE2080L. All dimensions in mm. Nozzle drawing courtesy of Ching Yi Technology Pte Ltd (part #: JUK-0547/12).

6.2 Pick-and-Place Machine Optimization

Pick and place machines are typically equipped with special pneumatic or electric feeders to advance the tape containing the LEDs. In pneumatic feeders, air pressure is used to actuate an air cylinder which then turns the sprocket wheel to index the pocket tape; electric feeders, in contrast, use electric motors to turn the sprocket wheel (see Figure 12). Electric feeders often also contain a panel which allows an operator to control the electric feeder manually.

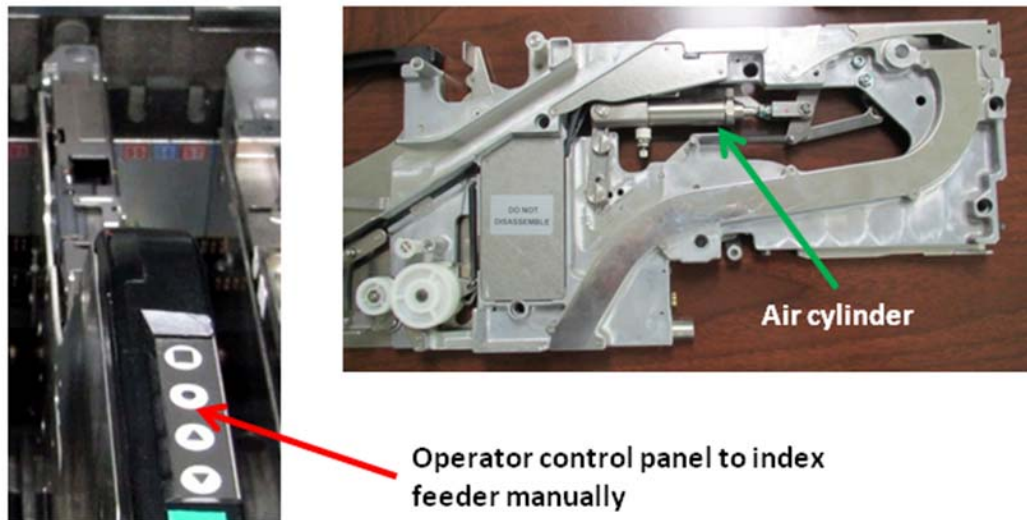

Figure 12. Examples of an electric feeder (left) and a pneumatic feeder (right) which are typically used in pick and place machines to advance the tape with LEDs.

The indexing step in the pick and place process may cause some LEDs to accidentally jump out of the pocket tape or may cause some LEDs to get misaligned inside the pocket tape, resulting in pick-up errors. Depending on the feeder design, minor modifications to the feeder can substantially improve the overall pick and place performance of the machine and reduce/eliminate the likelihood of damage to the dome of the LEDs.

There are many types of pick and place feeder designs available. Some feeders can be used as-is without any further modifications, some feeders require a shift in the position where the cover tape is peeled off the tape, and yet other feeders require the shutter to be completely removed so that the cover tape peeling position can be adjusted. Figure 13 shows representative pictures of each feeder design. Since there are many different feeder designs in use, it is important to understand the basic principle behind modifying the feeders so that effective modifications can still be carried out when different feeder designs are encountered.

The underlying principle behind each feeder modification is to protect the silicone dome with the cover tape until the LED is ready to be picked up by the nozzle. To achieve this, the cover tape should only be peeled off just before the nozzle picks up the LED (see Figure 14 and Figure 15).

In some instances, the new peeling location is not wide enough. In such cases, the peeling location needs to be widened so that the cover tape can be peeled off without any obstruction (see Figure 16).

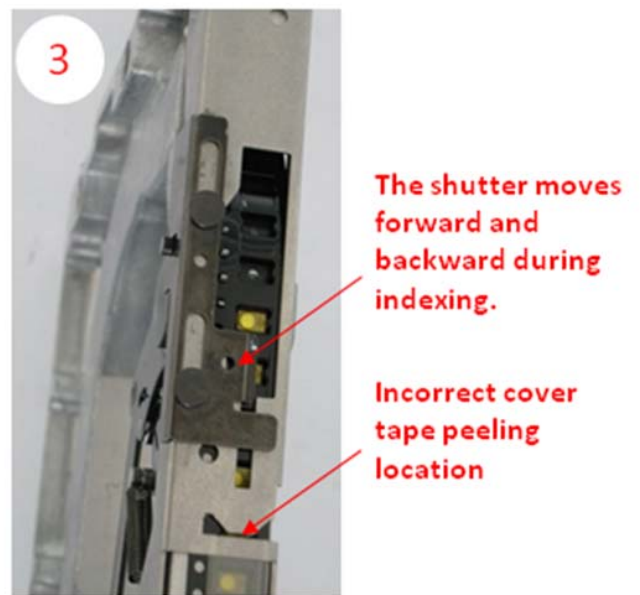
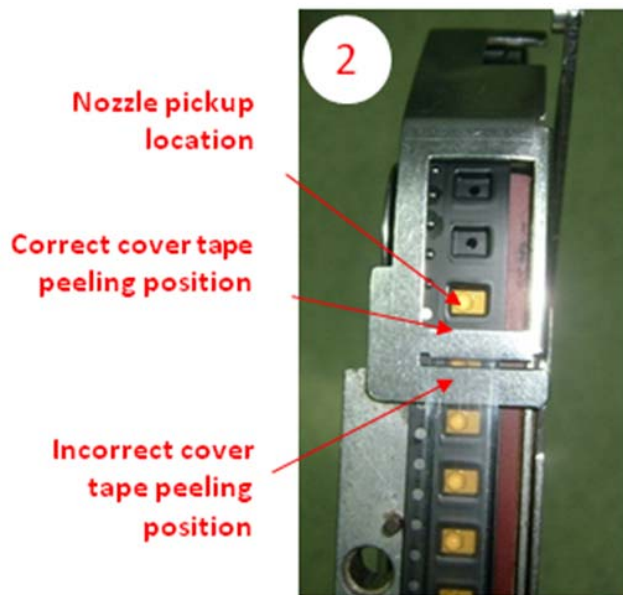
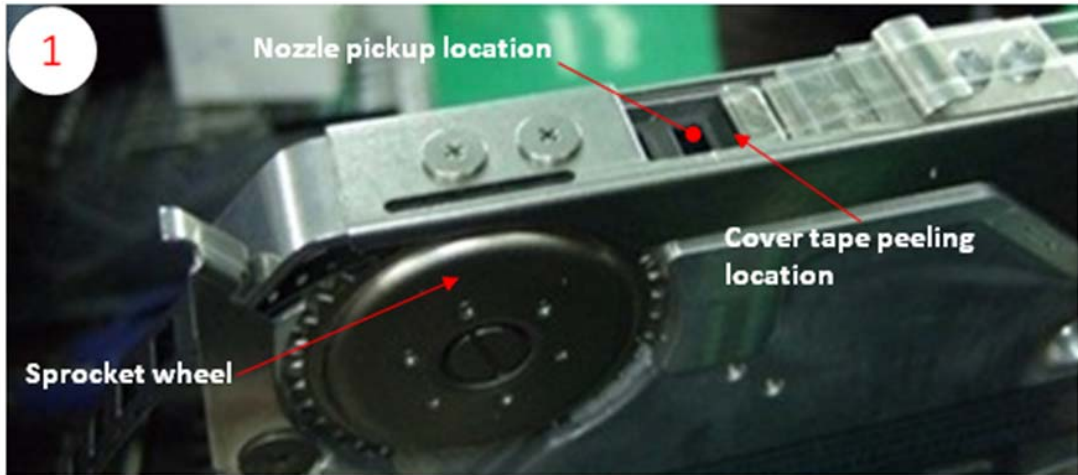

Figure 13. Three representative feeder designs. Feeder 1 does not require any modification. Feeder 2 requires the cover tape peeling position to be shifted. Feeder 3 requires the shutter to be removed before the cover tape peeling position can be adjusted.

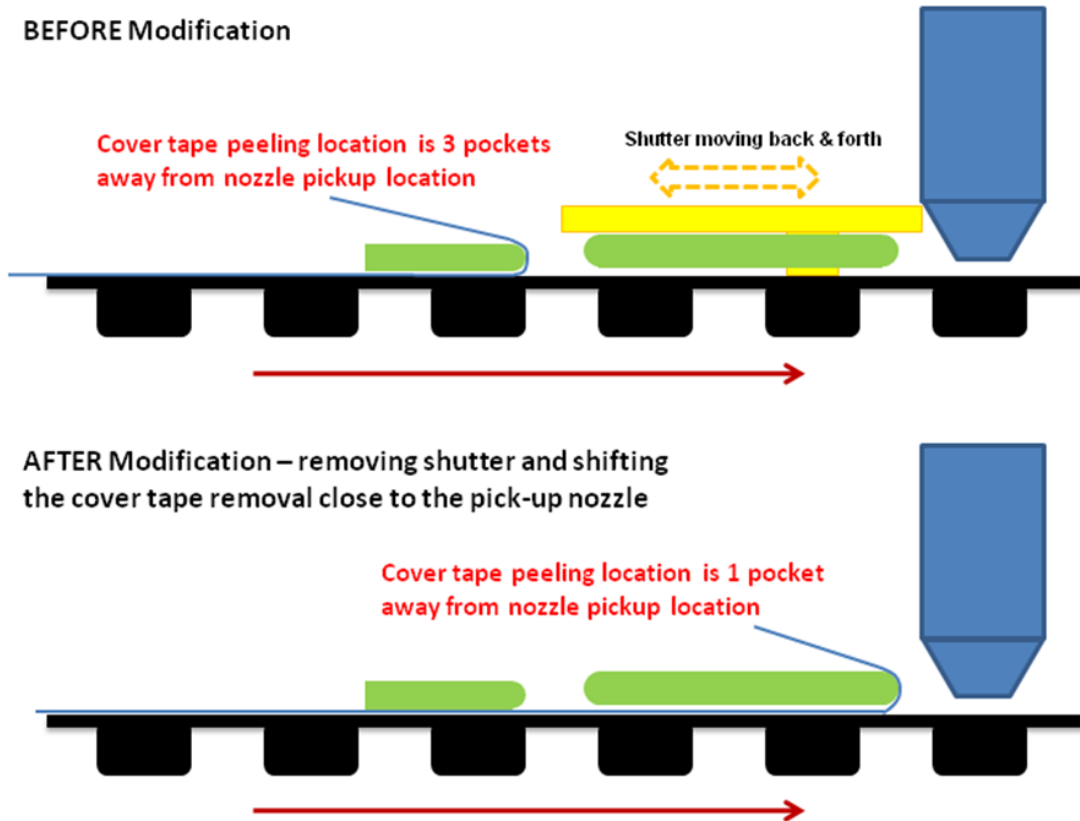

Figure 14. Illustration of the general principle behind the feeder modification.



Figure 15. Example of a modified feeder which protects the silicone dome prior to pickup.

The cover tape should be peeled-off here. To accommodate this, the red-colored regions may have to be removed. Otherwise, it obstructs proper peeling of the cover tape

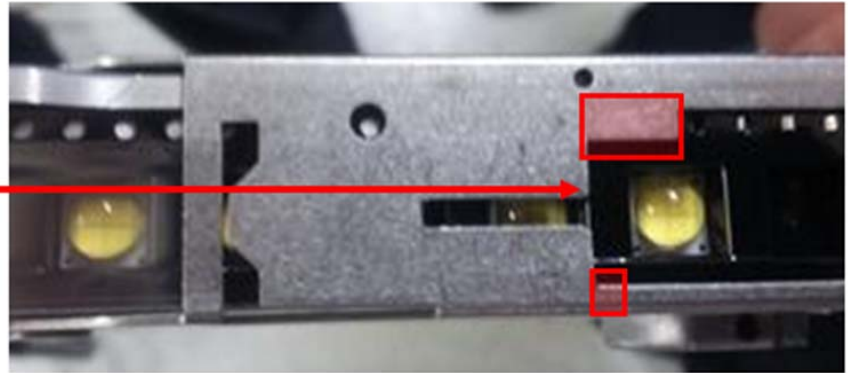

Figure 16. The cover tape peeling location in this feeder needs to be widened so that the cover tape can be peeled off without any obstruction.

To minimize the jerking of components in pneumatic feeders during indexing, it may be necessary to install an air pressure control valve. In some pneumatic feeder designs, such a control valve is already integrated by the machine supplier; in others an external control valve may have to be installed (see Figure 17).

Figure 18 shows examples of pneumatic and electric feeders before and after modification.

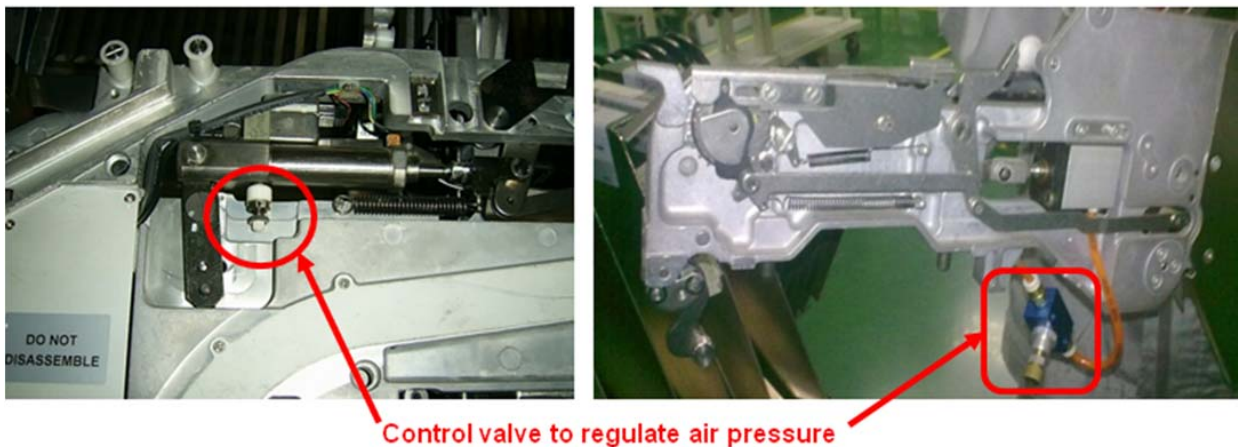

Figure 17. Pneumatic feeder with integrated air pressure control valve (left) and pneumatic feeder with air pressure control valve installed afterwards (right).

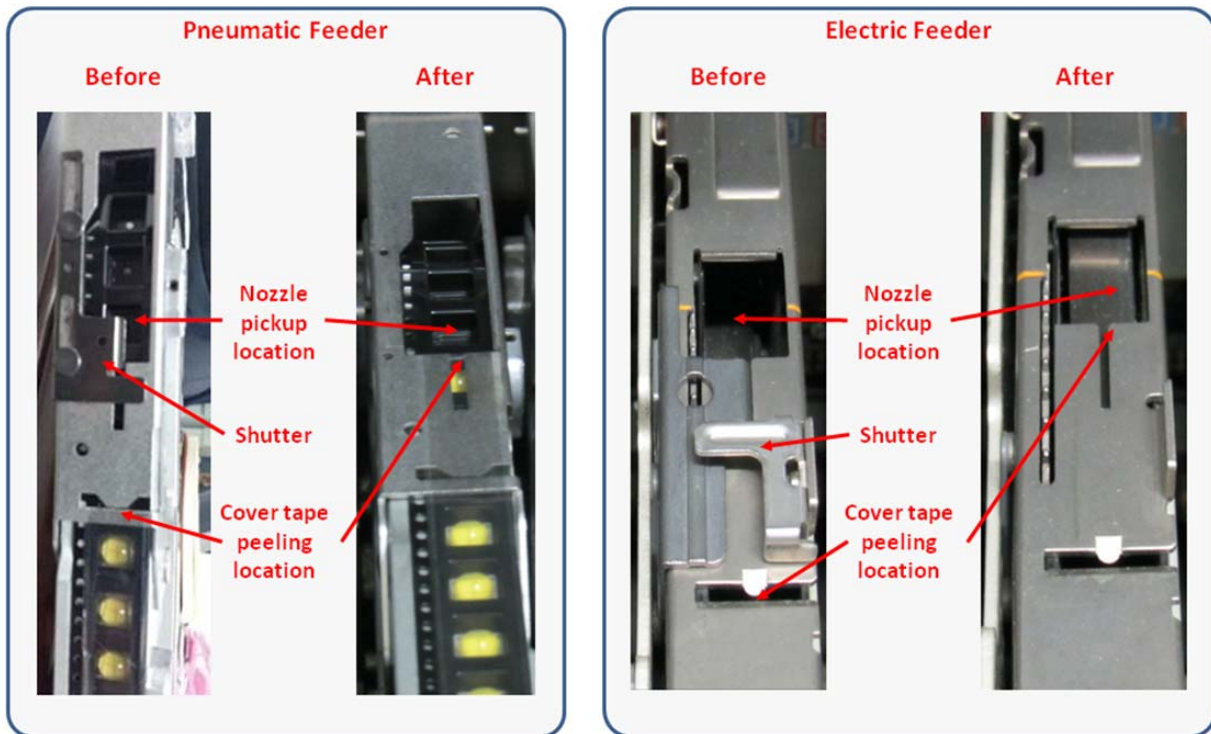

Figure 18. Example of pneumatic feeder (left) and electric feeder (right) before and after modification.

7. Packaging Considerations — Chemical Compatibility

The LUXEON emitter contains a silicone overcoat to protect the LED chip. As with most silicones used in LED optics, care must be taken to prevent any incompatible chemicals from directly or indirectly reacting with the silicone.

The silicone overcoat in the LUXEON emitter is gas permeable. Consequently, oxygen and volatile organic compound (VOC) gas molecules can diffuse into the silicone overcoat. VOCs may originate from adhesives, solder fluxes, conformal coating materials, potting materials and even some of the inks that are used to print the PCBs.

Some VOCs and chemicals react with silicone and produce discoloration and surface damage. Other VOCs do not chemically react with the silicone material directly but diffuse into the silicone and oxidize during the presence of heat or light. Regardless of the physical mechanism, both cases may affect the total LED light output. Since silicone permeability increases with temperature, more VOCs may diffuse into and/or evaporate out from the silicone.

Careful consideration must be given to whether LUXEON emitters are enclosed in an “air tight” environment or not. In an “air tight” environment, some VOCs that were introduced during assembly may permeate and remain in the silicone overcoat. Under heat and “blue” light, the VOCs inside the silicone overcoat may partially oxidize and create a silicone discoloration, particularly on the surface of the LED where the flux energy is the highest. In an air rich or “open” air environment, VOCs have a chance to leave the area (driven by the normal air flow). Transferring the devices which were discolored in the enclosed environment back to “open” air may allow the oxidized VOCs to diffuse out of the silicone overcoat and may restore the original optical properties of the LED.

Determining suitable threshold limits for the presence of VOCs is very difficult since these limits depend on the type of enclosure used to house the LEDs and the operating temperatures. Also, some VOCs can photo-degrade over time.

Table 3 provides a list of commonly used chemicals that should be avoided as they may react with the silicone material. Note that Lumileds does not warrant that this list is exhaustive since it is impossible to determine all chemicals that may adversely affect LED performance.

The chemicals in Table 3 are typically not directly used in the final products that are built around LUXEON emitters. However, some of these chemicals may be used in intermediate manufacturing steps (e.g. cleaning agents). Consequently, trace amounts of these chemicals may remain on (sub)components, such as heat sinks. Lumileds, therefore, recommends the following precautions when designing your application:

- When designing secondary lenses to be used over an LED, provide a sufficiently large air-pocket and allow for “ventilation” of this air away from the immediate vicinity of the LED.
- Use mechanical means of attaching lenses and circuit boards as much as possible. When using adhesives, potting compounds and coatings, carefully analyze its material composition and do thorough testing of the entire fixture under High Temperature over Life (HTOL) conditions.

Table 3. List of commonly used chemicals that will damage the silicone overcoat of the LUXEON emitter. Avoid using any of these chemicals in the housing that contains the LED package.

CHEMICAL NAME	NORMALLY USED AS
Hydrochloric acid	acid
Sulfuric acid	acid
Nitric acid	acid
Acetic acid	acid
Sodium hydroxide	alkali
Potassium hydroxide	alkali
Ammonia	alkali
MEK (Methyl Ethyl Ketone)	solvent
MIBK (Methyl Isobutyl Ketone)	solvent
Toluene	solvent
Xylene	solvent
Benzene	solvent
Gasoline	solvent
Mineral spirits	solvent
Dichloromethane	solvent
Tetrachlorometane	solvent
Castor oil	oil
Lard	oil
Linseed oil	oil
Petroleum	oil
Silicone oil	oil
Halogenated hydrocarbons (containing F, Cl, Br elements)	misc
Rosin flux	solder flux
Acrylic tape	adhesive



About Lumileds

Lumileds is the light engine leader, delivering innovation, quality and reliability.

For 100 years, Lumileds commitment to innovation has helped customers pioneer breakthrough products in the automotive, consumer and illumination markets.

Lumileds is shaping the future of light with our LEDs and automotive lamps, and helping our customers illuminate how people see the world around them.

To learn more about our portfolio of light engines, visit lumileds.com.



©2015 Lumileds Holding B.V. All rights reserved.
LUXEON is a registered trademark of the Lumileds Holding B.V.
in the United States and other countries.

lumileds.com

Neither Lumileds Holding B.V. nor its affiliates shall be liable for any kind of loss of data or any other damages, direct, indirect or consequential, resulting from the use of the provided information and data. Although Lumileds Holding B.V. and/or its affiliates have attempted to provide the most accurate information and data, the materials and services information and data are provided "as is," and neither Lumileds Holding B.V. nor its affiliates warrants or guarantees the contents and correctness of the provided information and data. Lumileds Holding B.V. and its affiliates reserve the right to make changes without notice. You as user agree to this disclaimer and user agreement with the download or use of the provided materials, information and data.