

STELLA-A

Type II and III beam for street lighting.
Compatible with up to 23 mm LES size COBs.

TECHNICAL SPECIFICATIONS:

Dimensions	Ø 90.0 mm
Height	22 mm
Fastening	screw
Colour	black
Box size	
Box weight	6.6 kg
Quantity in Box	100 pcs
ROHS compliant	yes ⓘ



MATERIAL SPECIFICATIONS:

Component	Type	Material	Colour
STELLA-A	Single lens	Silicone	clear
STELLA-FRAME	Holder	PA66	black

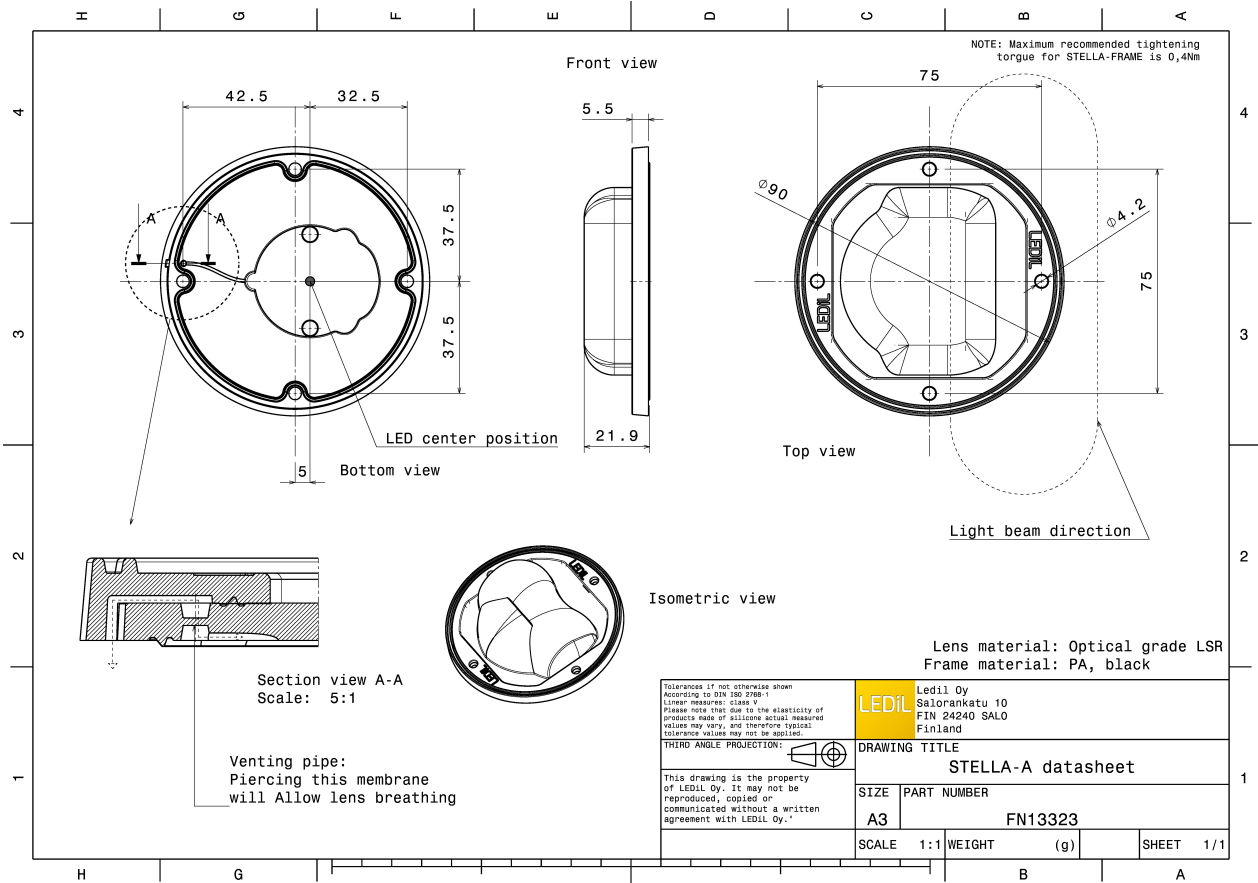

PHOTOMETRIC DATA (MEASURED):

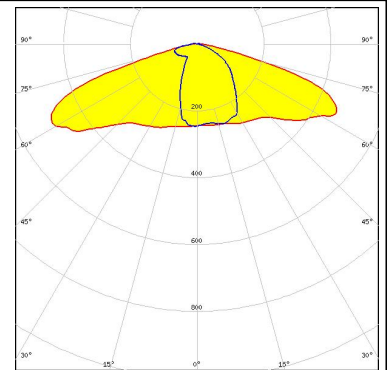
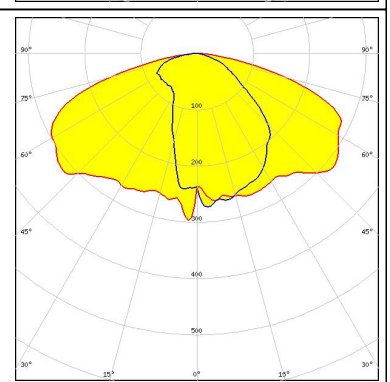
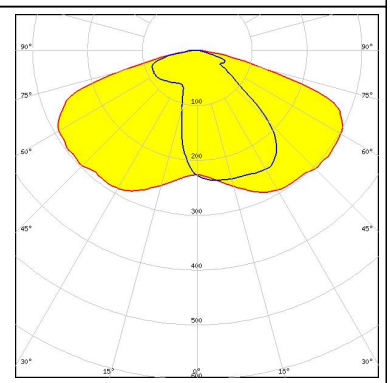
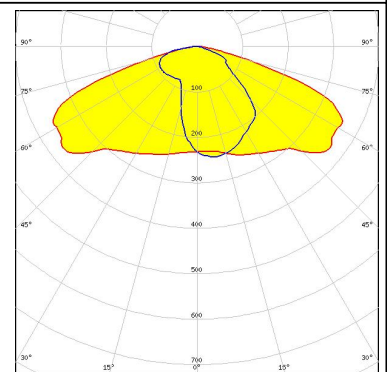
<p>bridgelux.</p> <p>LED V15 Gen6</p> <p>FWHM Asymmetric</p> <p>Efficiency 91 %</p> <p>Peak intensity 0.550 cd/lm</p> <p>LEDs/each optic 1</p> <p>Light colour White</p> <p>Required components:</p>	
<p>bridgelux.</p> <p>LED V18 Gen7</p> <p>FWHM Asymmetric</p> <p>Efficiency 85 %</p> <p>Peak intensity 0.400 cd/lm</p> <p>LEDs/each optic 1</p> <p>Light colour White</p> <p>Required components:</p>	
<p>bridgelux.</p> <p>LED VERO13</p> <p>FWHM Asymmetric</p> <p>Efficiency 92 %</p> <p>Peak intensity 0.660 cd/lm</p> <p>LEDs/each optic 1</p> <p>Light colour White</p> <p>Required components:</p>	
<p>bridgelux.</p> <p>LED VERO18</p> <p>FWHM Asymmetric</p> <p>Efficiency 92 %</p> <p>Peak intensity 0.500 cd/lm</p> <p>LEDs/each optic 1</p> <p>Light colour White</p> <p>Required components:</p>	

PHOTOMETRIC DATA (MEASURED):

CITIZEN

LED CLL03x/CLU03x
FWHM Asymmetric
Efficiency 92 %
Peak intensity 0.616 cd/lm
LEDs/each optic 1
Light colour White
Required components:
Bender Wirth: 433 Typ L1

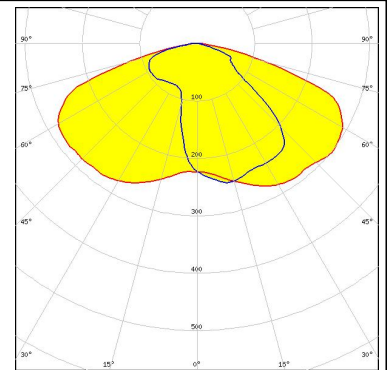
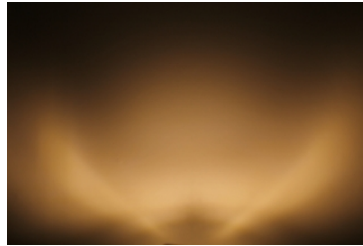

CITIZEN

LED CLU700/701
FWHM Asymmetric
Efficiency 89 %
Peak intensity 1.400 cd/lm
LEDs/each optic 1
Light colour White
Required components:
Bender Wirth: 434 Typ L1

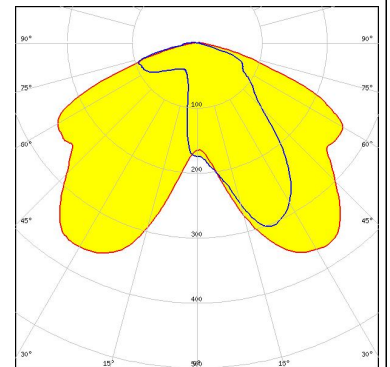
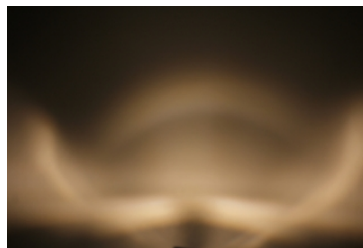

CITIZEN

LED CLU710/711
FWHM Asymmetric
Efficiency 89 %
Peak intensity 0.960 cd/lm
LEDs/each optic 1
Light colour White
Required components:

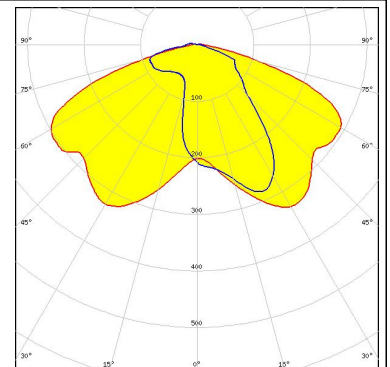

CITIZEN

LED CLU720/721
FWHM Asymmetric
Efficiency %
Peak intensity 0.730 cd/lm
LEDs/each optic 1
Light colour White
Required components:

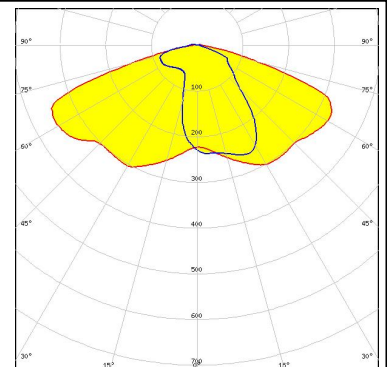

PHOTOMETRIC DATA (MEASURED):

CITIZEN

LED CLU720/721
 FWHM Asymmetric
 Efficiency 91 %
 Peak intensity 0.760 cd/lm
 LEDs/each optic 1
 Light colour White
 Required components:
 Bender Wirth: 433 Typ L1

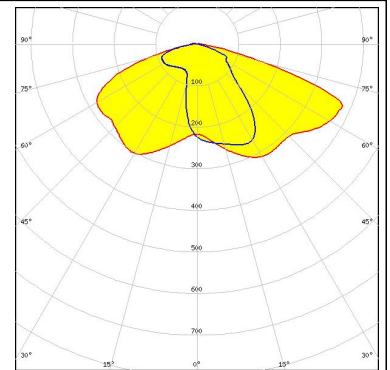
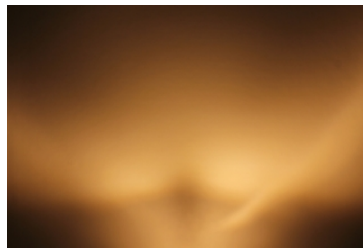

CREE

LED CXA/B 15xx
 FWHM Asymmetric
 Efficiency 92 %
 Peak intensity 1.100 cd/lm
 LEDs/each optic 1
 Light colour White
 Required components:

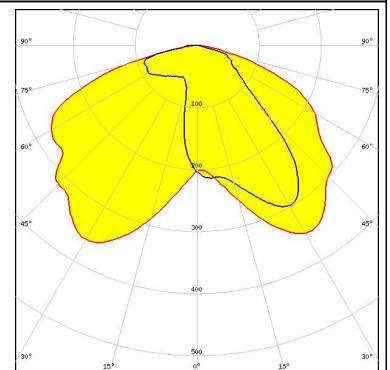

CREE

LED CXA/B 15xx
 FWHM Asymmetric
 Efficiency 89 %
 Peak intensity 1.000 cd/lm
 LEDs/each optic 1
 Light colour White
 Required components:
 C14305_STELLA-CLAMP-CXA15-18

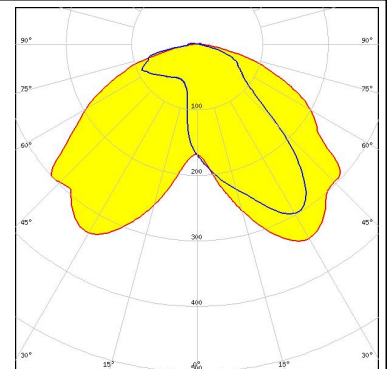

CREE

LED CXA/B 15xx
 FWHM Asymmetric
 Efficiency 92 %
 Peak intensity 0.850 cd/lm
 LEDs/each optic 1
 Light colour White
 Required components:
 Bender Wirth: 441 Typ L1

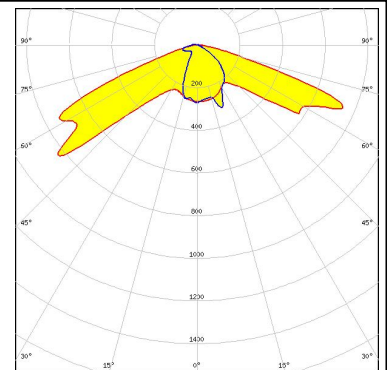
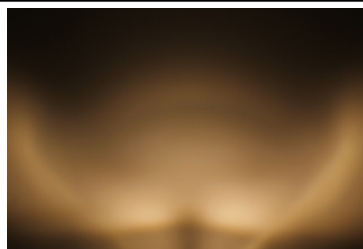

PHOTOMETRIC DATA (MEASURED):



LED CXA/B 1816 & CXA/B 1820 & CXA 1850
 FWHM Asymmetric
 Efficiency 89 %
 Peak intensity 0.670 cd/lm
 LEDs/each optic 1
 Light colour White
 Required components:
 Bender Wirth: 437 Typ L1

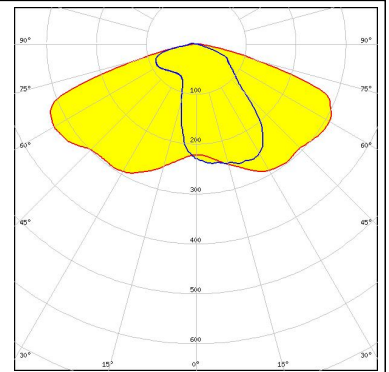

LED CXA/B 1816 & CXA/B 1820 & CXA 1850
 FWHM Asymmetric
 Efficiency 87 %
 Peak intensity 0.670 cd/lm
 LEDs/each optic 1
 Light colour White
 Required components:

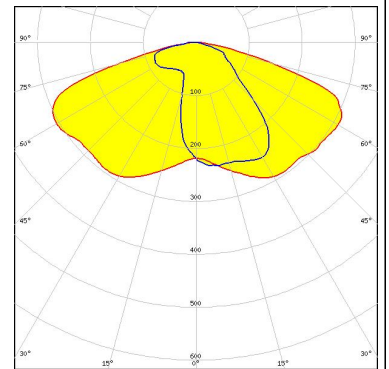

LED CXA/B 1816 & CXA/B 1820 & CXA 1850
 FWHM Asymmetric
 Efficiency 87 %
 Peak intensity 0.620 cd/lm
 LEDs/each optic 1
 Light colour White
 Required components:

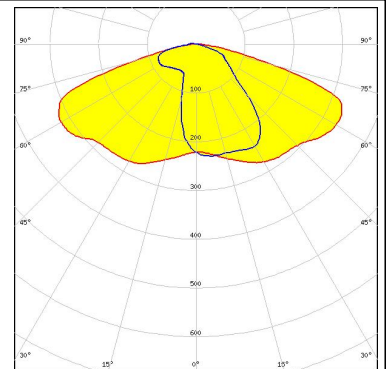

LED CXA/B 1816 & CXA/B 1820 & CXA 1850
 FWHM Asymmetric
 Efficiency 92 %
 Peak intensity 0.740 cd/lm
 LEDs/each optic 1
 Light colour White
 Required components:
 C14305_STELLA-CLAMP-CXA15-18

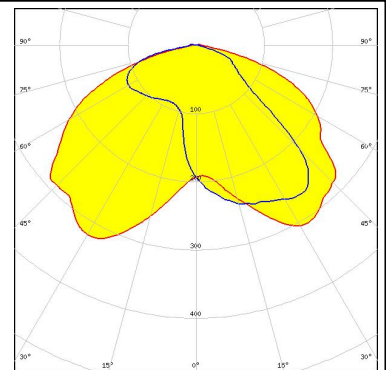

PHOTOMETRIC DATA (MEASURED):



LED CXA/B 25xx
 FWHM Asymmetric
 Efficiency 93 %
 Peak intensity 0.490 cd/lm
 LEDs/each optic 1
 Light colour White
 Required components:

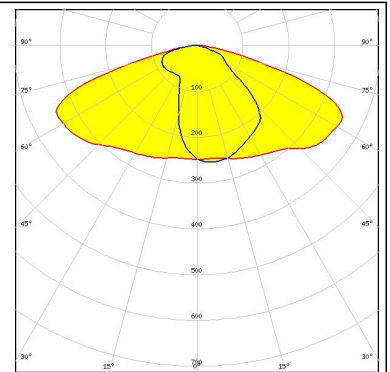

LED LUXEON CoB 1202/1203
 FWHM Asymmetric
 Efficiency 88 %
 Peak intensity 0.910 cd/lm
 LEDs/each optic 1
 Light colour White
 Required components:
 Bender Wirth: 438 Typ L1

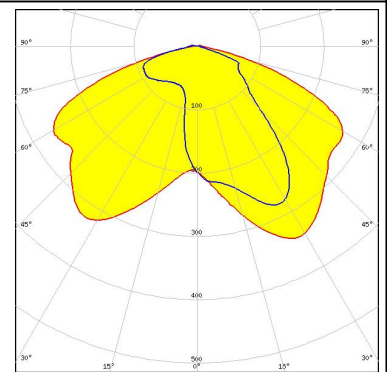

LED LUXEON CoB 1208
 FWHM Asymmetric
 Efficiency %
 Peak intensity 0.300 cd/lm
 LEDs/each optic 1
 Light colour White
 Required components:

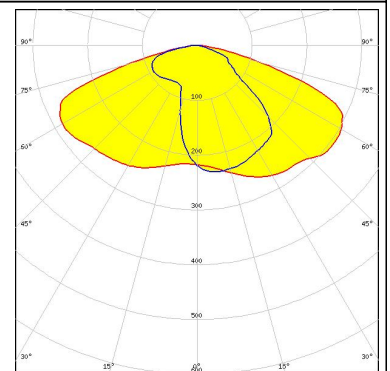

LED CXM-14
 FWHM Asymmetric
 Efficiency 90 %
 Peak intensity 0.580 cd/lm
 LEDs/each optic 1
 Light colour White
 Required components:

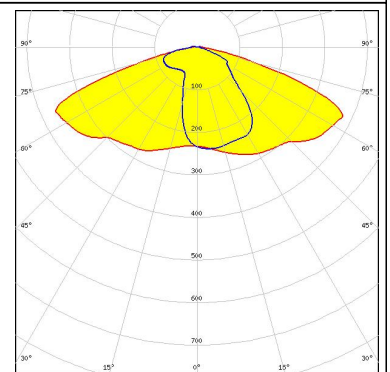

PHOTOMETRIC DATA (MEASURED):



LED CXM-18
 FWHM Asymmetric
 Efficiency 89 %
 Peak intensity 0.460 cd/lm
 LEDs/each optic 1
 Light colour White
 Required components:

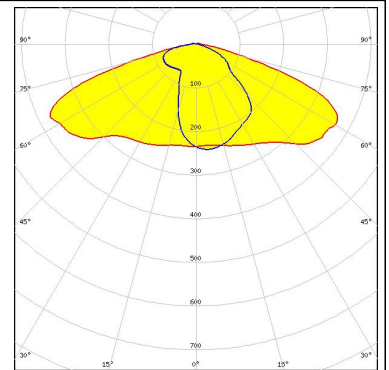

LED COB J-Type
 FWHM Asymmetric
 Efficiency 87 %
 Peak intensity 0.500 cd/lm
 LEDs/each optic 1
 Light colour White
 Required components:

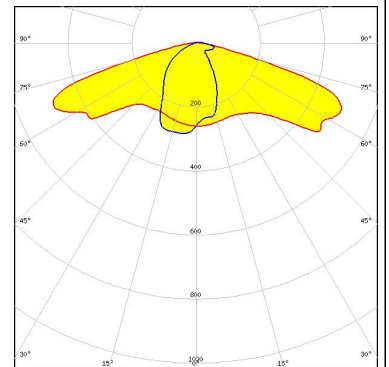

LED COB L-Type (LES 11)
 FWHM Asymmetric
 Efficiency 89 %
 Peak intensity 0.720 cd/lm
 LEDs/each optic 1
 Light colour White
 Required components:
 Bender Wirth: 438 Typ L1

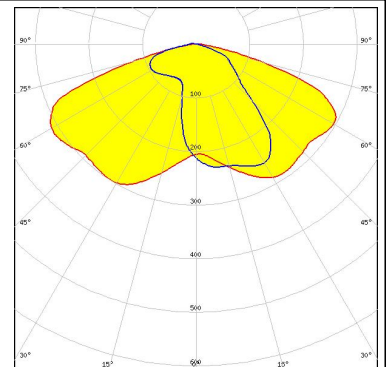

LED COB L-Type (LES 9)
 FWHM Asymmetric
 Efficiency 90 %
 Peak intensity 0.930 cd/lm
 LEDs/each optic 1
 Light colour White
 Required components:
 Bender Wirth: 438 Typ L1

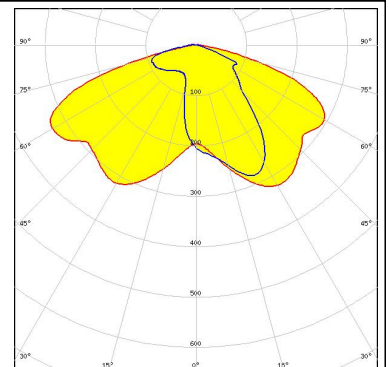

PHOTOMETRIC DATA (MEASURED):

OSRAM Opto Semiconductors

LED Soleriq S13
FWHM Asymmetric
Efficiency 91 %
Peak intensity 0.700 cd/lm
LEDs/each optic 1
Light colour White
Required components:

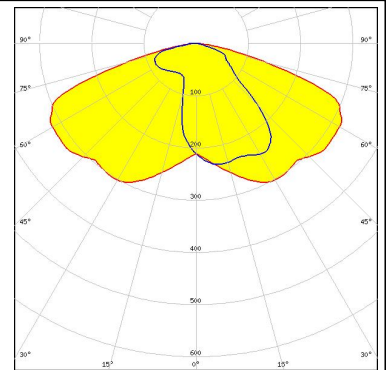

OSRAM Opto Semiconductors

LED Soleriq S13
FWHM Asymmetric
Efficiency 92 %
Peak intensity 0.690 cd/lm
LEDs/each optic 1
Light colour White
Required components:
Bender Wirth: 437 Typ L1

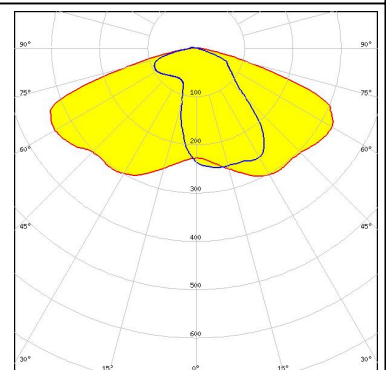

OSRAM Opto Semiconductors

LED Soleriq S19
FWHM Asymmetric
Efficiency 90 %
Peak intensity 0.500 cd/lm
LEDs/each optic 1
Light colour White
Required components:

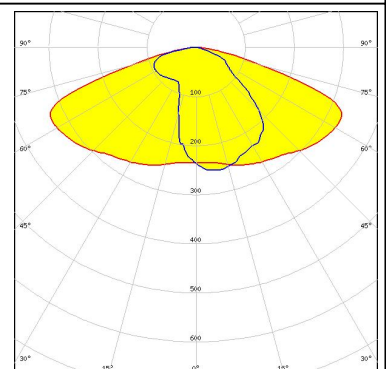

SAMSUNG

LED COB D Series LES 14.5 mm
FWHM Asymmetric
Efficiency 87 %
Peak intensity 0.510 cd/lm
LEDs/each optic 1
Light colour White
Required components:

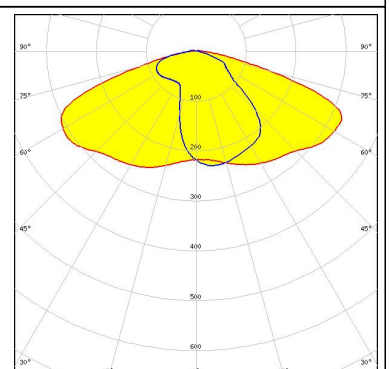

PHOTOMETRIC DATA (MEASURED):

SHARP

LED Mega Zenigata (GW6DME)
FWHM Asymmetric
Efficiency 90 %
Peak intensity 0.570 cd/lm
LEDs/each optic 1
Light colour White
Required components:

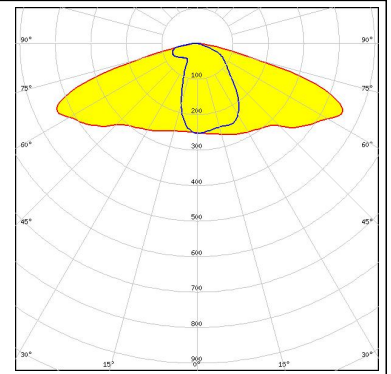

PHOTOMETRIC DATA (SIMULATED):

bridgelux

LED V10 Gen7
FWHM Asymmetric
Efficiency 89 %
Peak intensity 0.560 cd/lm
LEDs/each optic 1
Light colour White
Required components:
Bender Wirth: 486 Typ L1

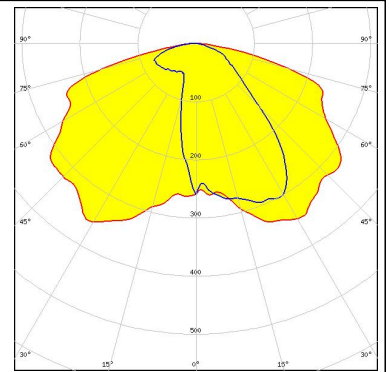

bridgelux

LED V13 Gen7
FWHM Asymmetric
Efficiency 89 %
Peak intensity 0.550 cd/lm
LEDs/each optic 1
Light colour White
Required components:
Bender Wirth: 477 Typ L1

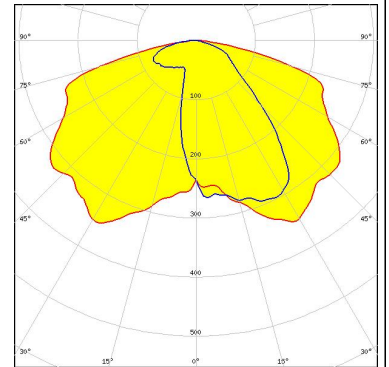

CITIZEN

LED CLL02x/CLU02x (LES10)
FWHM Asymmetric
Efficiency 91 %
Peak intensity 0.730 cd/lm
LEDs/each optic 1
Light colour White
Required components:

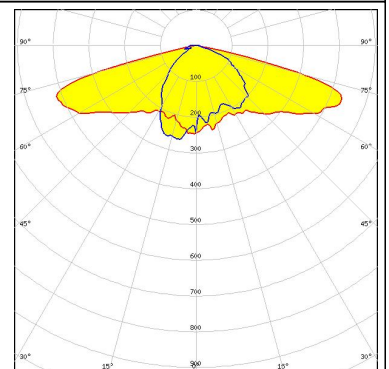

CITIZEN

LED CLL03x/CLU03x
FWHM Asymmetric
Efficiency 90 %
Peak intensity 0.490 cd/lm
LEDs/each optic 1
Light colour White
Required components:

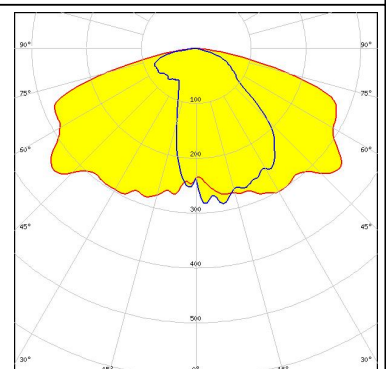

GENERAL INFORMATION:

NOTE: The typical beam angle will be changed by different color, chip size and chip position tolerance. The typical total beam angle is the full angle measured where the luminous intensity is half of the peak value.

Due to use of high power COB's with this product, special attention to proper thermal design is highly recommended. LEDiL has no liability for direct, indirect or consecutive damages arising from the LEDiL products being used outside of the recommended temperature range.

MATERIALS:

As part of our continuous research and improvement processes, and to ensure the best possible quality and availability of our products, LEDiL reserves the right to change material grades without notice.

PRODUCT DATA USER AGREEMENT AND DISCLAIMER:

The measured data in the provided downloadable LEDiL Product Datasheets and Mechanical 2D-Drawings is rounded and provided as reference for planning. LEDiL Oy's optical specifications have been verified by conducting performance testing of the products in accordance with the company's quality system. The reported data are averaged results of multiple measurements with typical variation. LEDiL Oy reserves the right to without prior notification make changes and improvements to its products.

LEDiL Oy assumes neither warranty, nor guarantee nor any other liability of any kind for the contents and correctness of the provided data. The provided data has been generated with highest diligence but the provided data may in reality not represent the complete possible variation range of all intrinsic parameters. Therefore, in certain cases a deviation from the provided data could occur.

LEDiL Oy reserves the right to undertake technical changes of its products without further notification which could lead to changes in the provided data. LEDiL Oy assumes no liability of any kind for the possible deviation from any provided data or any other damage resulting from the usage of the provided data.

The user agrees to this disclaimer and user agreement with the download or usage of the provided files.

LEDiL Oy

Joensuunkatu 13
FI-24240 SALO
Finland

LEDiL Inc.

228 West Page Street
Suite D
Sycamore IL 60178
USA

Local sales and technical support

[www.ledil.com/
where_to_buy](http://www.ledil.com/where_to_buy)

Shipping locations

Salo, Finland
Hong Kong, China

Distribution Partners

[www.ledil.com/
where_to_buy](http://www.ledil.com/where_to_buy)