

DELPHI SERIES



FEATURES

- High Efficiency:
94.0% @ 12Vin, 5V/20A out
- Size:
Vertical: 30.5x15.5x12.0mm
(1.20"x0.61"x0.47")
Horizontal: 30.5x15.5x12.9mm
(1.20"x0.61"x0.51")
- Wide input range: 4.5V~13.8V
- Output voltage programmable from 0.59Vdc to 5.1Vdc via external resistors
- Voltage and resistor-based trim
- No minimum load required
- Fixed frequency operation
- Input UVLO, output OCP
- Remote ON/OFF (Positive)
- ISO 9001, TL 9000, ISO 14001, QS9000, OHSAS18001 certified manufacturing facility
- UL/cUL 60950-1 (US & Canada) Recognized

Delphi NE Series Non-Isolated Point of Load DC/DC Modules: 4.5V~13.8Vin, 0.59V~5.1Vout, 20A

The Delphi NE 20A Series, 4.5 to 13.8V wide input, wide trim single output, non-isolated point of load DC/DC converters are the latest offering from a world leader in power systems technology and manufacturing — Delta Electronics, Inc. The ND/NE product family is the second generation, non-isolated point-of-load DC/DC power modules for the datacom applications which cut the module size by almost 50% in most of the cases compared to the first generation NC series POL modules. The product family here provides 20A of output current in a vertically or horizontally mounted through-hole package and the output can be resistor trimmed from 0.59Vdc to 5.1Vdc. It provides a very cost effective, high efficiency, and high density point of load solution. With creative design technology and optimization of component placement, these converters possess outstanding electrical and thermal performance, as well as extremely high reliability under highly stressful operating conditions.

OPTIONS

- Vertical or horizontal versions

APPLICATIONS

- DataCom
- Distributed power architectures
- Servers and workstations
- LAN/WAN applications
- Data processing applications

TECHNICAL SPECIFICATIONS

(Ambient Temperature=25°C, minimum airflow=200LFM, nominal $V_{in}=12V_{dc}$ unless otherwise specified.)

PARAMETER	NOTES and CONDITIONS	NE12S0A0V/H20			
		Min.	Typ.	Max.	Units
ABSOLUTE MAXIMUM RATINGS					
Input Voltage	operation	4.5		13.8	Vdc
Operating Temperature (Vertical)	Refer to Fig.25 for the measuring point	-40		130	°C
Storage Temperature		-55		125	°C
INPUT CHARACTERISTICS					
Operating Input Voltage		4.5		13.8	V
Input Under-Voltage Lockout					
Turn-On Voltage Threshold			4.3		V
Turn-Off Voltage Threshold			3.3		V
Lockout Hysteresis Voltage			1.0		V
Maximum Input Current	12Vin, 5Vo, operating, full load		8.9		A
No-Load Input Current	Vin=12V, Vout=5V		150		mA
Off Converter Input Current	Remote OFF		10		mA
Input Reflected-Ripple Current	P-P thru 2uH inductor 5Hz to 20MHz		30		mA
Input Ripple Rejection	120Hz		60		dB
OUTPUT CHARACTERISTICS					
Output Voltage Adjustment Range		0.59		5.1	V
Output Voltage Set Point	With a 0.1% trim resistor	-1		+1	%Vo
Output Voltage Regulation					
Over Load	Io=Io_min to Io_max	-0.5		+0.5	%Vo
Over Line	Vin=Vin_min to Vin_max	-0.2		+0.2	%Vo
Over temperature	Ta=0°C to 70°C	-0.3		+0.3	%Vo
Total output range	Over load, line, temperature regulation and set point	-2.0		+2.0	%Vo
Output Voltage Ripple and Noise	5Hz to 20MHz bandwidth				
Peak-to-Peak	Full Load, 10uF Tan cap, 12Vin, 5Vo		20		mV
RMS	Full Load, 10uF Tan cap, 12Vin, 5Vo		5		mV
Output Current Range		0		20	A
Output Voltage Under-shoot at Power-Off	Vin=12V, Turn OFF			100	mV
Output short-circuit current, RMS value	Continuous		3.6		A
Output DC Current-Limit Inception	Hiccup mode	110		200	%Iomax
DYNAMIC CHARACTERISTICS					
Output Dynamic Load Response	12Vin, 2.5Vout, 10uF ceramic cap				
Positive Step Change in Output Current	75-100% load, 5A/uS		200		mV
Negative Step Change in Output Current	100-75% load, 5A/uS		200		mV
Settling Time	Settling to be within regulation band (to 10% Vo deviation)		100		µs
Turn-On Transient					
Start-Up Time, from On/Off Control	From Enable high to 90% of Vo		2	3	ms
Start-Up Time, from input power	From Vin=12V to 90% of Vo		2	3	ms
Minimum Output Capacitance		0			µF
5.0Vo, Maximum Output Capacitance	Turn on overshoot <1% vo, ESR ≥ 1mΩ		2000		µF
EFFICIENCY					
Vo=0.59V	Vin=12V, Io=20A		75		%
Vo=0.9V	Vin=12V, Io=20A		80.5		%
Vo=2.5V	Vin=12V, Io=20A		91		%
Vo=5.0V	Vin=12V, Io=20A		94		%
SINK EFFICIENCY					
Vo=5.0V	Vin=12V, Io=20A		92		%
FEATURE CHARACTERISTICS					
Switching Frequency	Fixed		500		KHz
ON/OFF Control	Positive logic (internally pulled high)				
Logic High	Module On (or leave the pin open)	0.8		5.0	V
Logic Low	Module Off	0		0.3	V
GENERAL SPECIFICATIONS					
Calculated MTBF	25°C, 300LFM, 80% load		9.8		Mhours
Weight			8.8		grams



ELECTRICAL CHARACTERISTICS CURVES

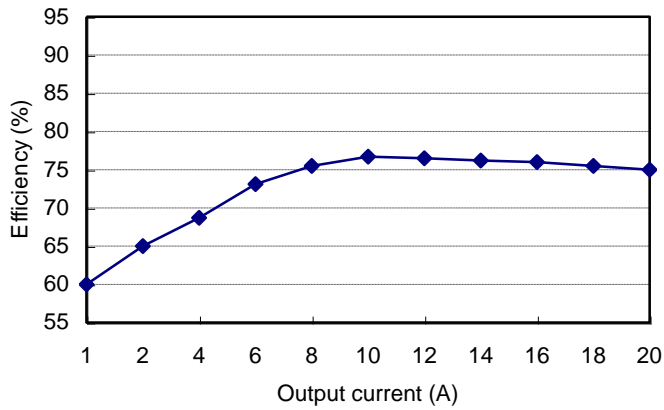

Figure 1: Converter efficiency vs. output current (0.59V output voltage, 12V input)

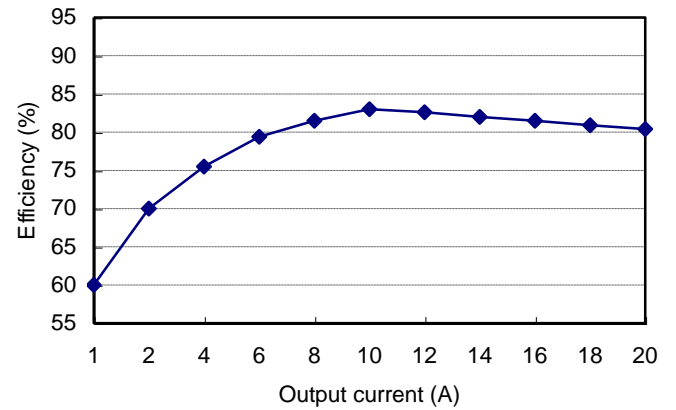

Figure 2: Converter efficiency vs. output current (0.9V output voltage, 12V input)

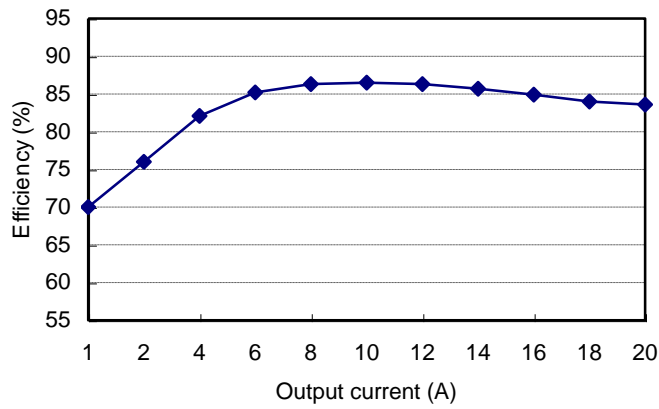

Figure 3: Converter efficiency vs. output current (1.5V output voltage, 12V input)

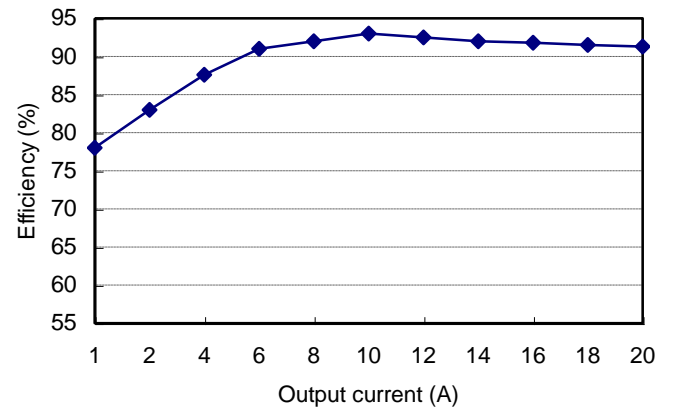

Figure 4: Converter efficiency vs. output current (2.5V output voltage, 12V input)

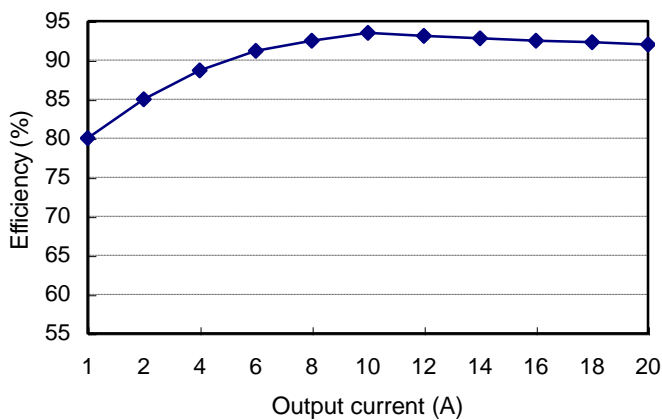

Figure 5: Converter efficiency vs. output current (3.3V output voltage, 12V input)

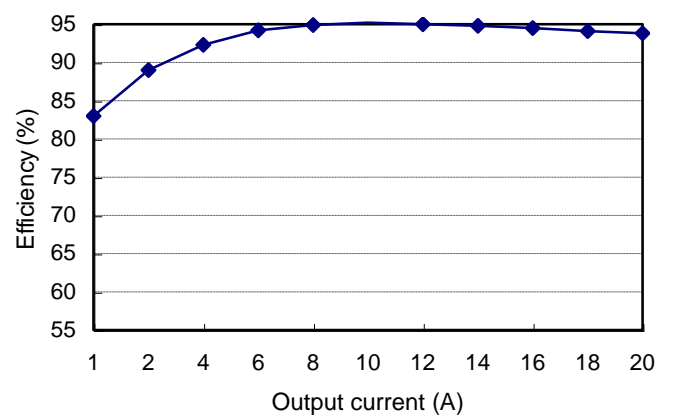

Figure 6: Converter efficiency vs. output current (5.0V output voltage, 12V input)



ELECTRICAL CHARACTERISTICS CURVES (CON.)

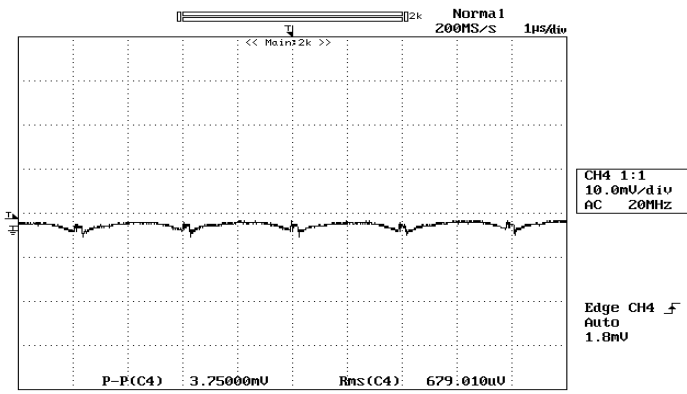

Figure 7: Output ripple & noise at 12Vin, 0.59V/20A out

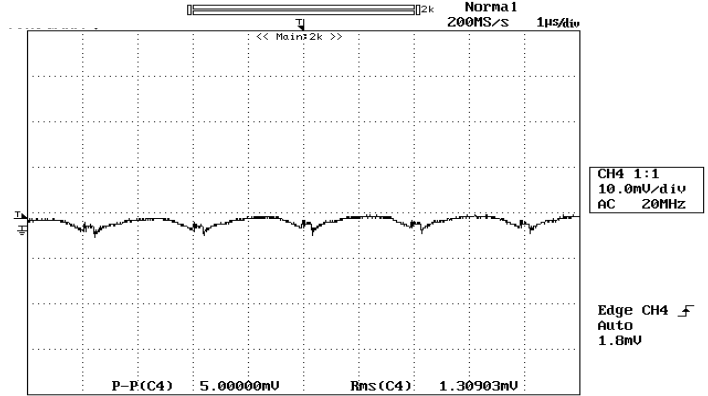

Figure 8: Output ripple & noise at 12Vin, 0.9V/20A out

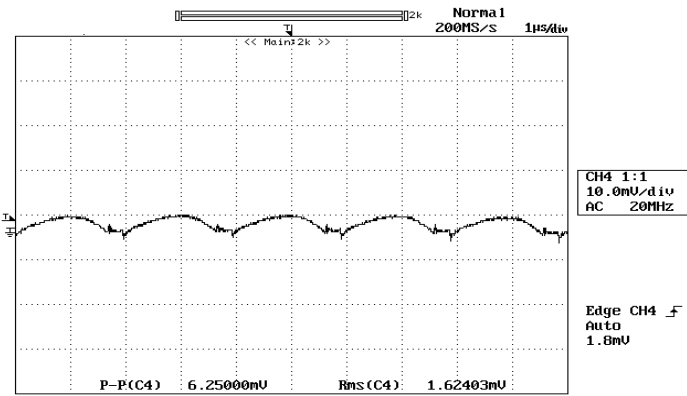

Figure 9: Output ripple & noise at 12Vin, 1.5V/20A out

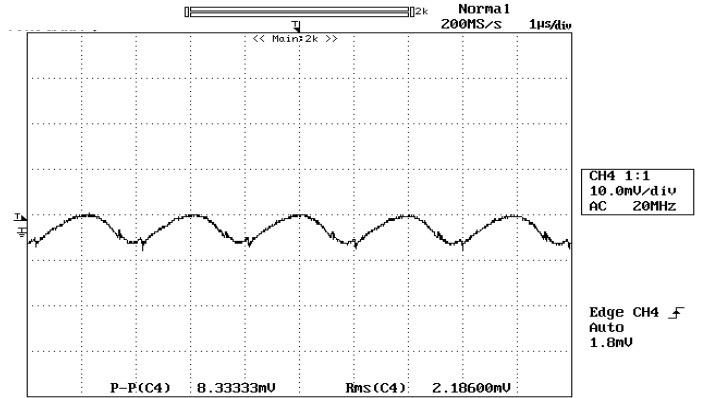

Figure 10: Output ripple & noise at 12Vin, 2.5V/20A out

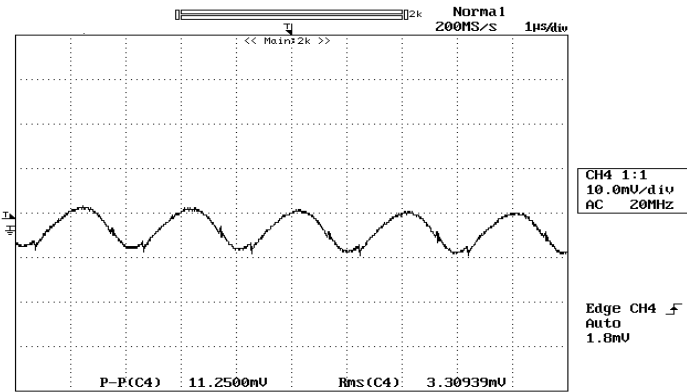

Figure 11: Output ripple & noise at 12Vin, 3.3V/20A out

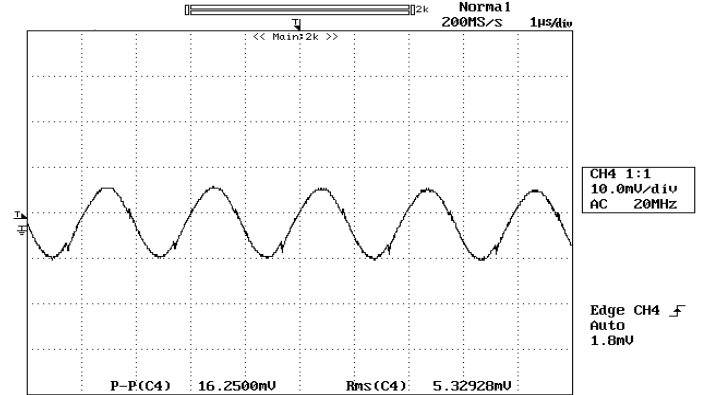

Figure 12: Output ripple & noise at 12Vin, 5.0V/20A out



ELECTRICAL CHARACTERISTICS CURVES (CON.)

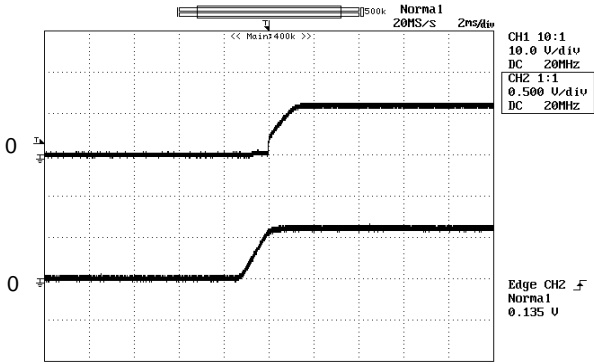

Figure 13: Turn on delay time at 12Vin, 0.59V/20A out
Ch1: Vin, Ch4: Vout

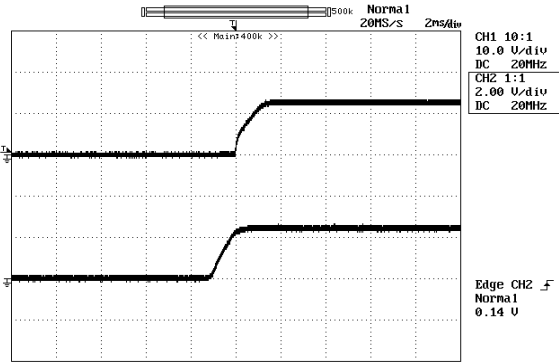

Figure 14: Turn on delay time Remote On/Off, 2.5V/20A out
Ch1: Enable, Ch4: Vout

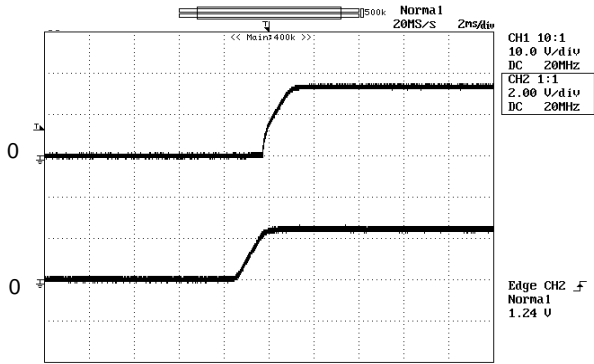

Figure 15: Turn on delay time at 12Vin, 3.3V/20A out
Ch1: Vin, Ch4: Vout

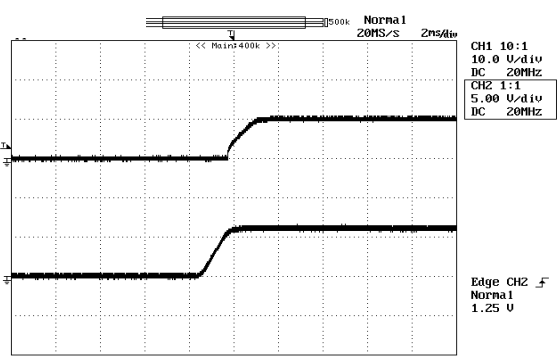

Figure 16: Turn on delay time at Remote On/Off, 5.0V/20A out
Ch1: Enable, Ch4: Vout

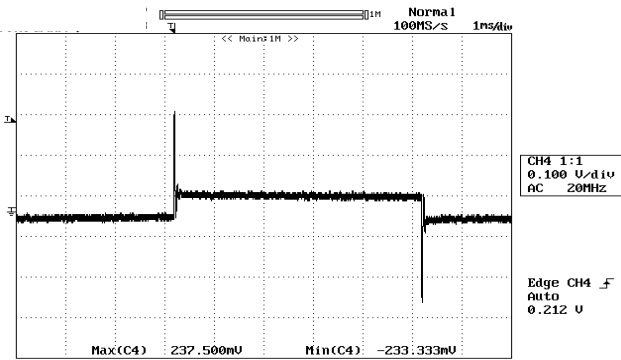

Figure 17: Typical transient response to step load change at 5A/μS
from 75%~100% load, at 12Vin, 2.5V out

DESIGN CONSIDERATIONS

The NE12S0A0V(H)20 uses a single phase and voltage mode controlled buck topology. The output can be trimmed in the range of 0.59Vdc to 5.1Vdc by a resistor from Trim pin to Ground.

The converter can be turned ON/OFF by remote control with positive on/off (ENABLE pin) logic. The converter DC output is disabled when the signal is driven low (below 0.3V). This pin is also used as the input turn on threshold judgment. Its voltage is percent of Input voltage during floating due to internal connection. So we do not suggest using an active high signal (higher than 0.8V) to turn on the module because this high level voltage will disable UVLO function. The module will turn on when this pin is floating and the input voltage is higher than the threshold.

The converter can protect itself by entering hiccup mode against over current and short circuit condition. Also, the converter will shut down when an over voltage protection is detected.

Safety Considerations

It is recommended that the user to provide a very fast-acting type fuse in the input line for safety. The output voltage set-point and the output current in the application could define the amperage rating of the fuse.

FEATURES DESCRIPTIONS

Enable (On/Off)

The ENABLE (on/off) input allows external circuitry to put the NE converter into a low power dissipation (sleep) mode. Positive ENABLE is available as standard. With the active high function, the output is guaranteed to turn on if the ENABLE pin is driven above 0.8V. The output will turn off if the ENABLE pin voltage is pulled below 0.3V

The ENABLE pin is also used as input UVLO function. Leaving the Enable floating, the module will turn on if the input voltage is higher than turn on threshold and turn off if the input voltage is lower than turn off threshold. The default Turn-on voltage is 4.3V with 1V Hysteresis.

The Turn-on voltage may be adjusted with a resistor placed between the "Enable" pin and "Ground" pin. The formula for calculating the value of this resistor is:

$$V_{EN_RTH} = \frac{50 \times (R + 18.2)}{18.2 \times R} + 1.5$$

$$V_{EN_FTH} = V_{EN_RTH} - 1$$

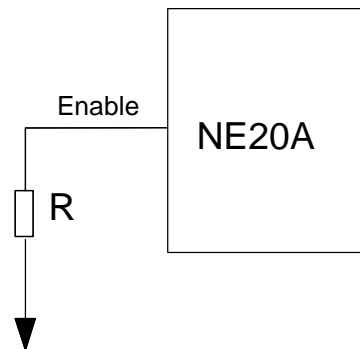

Fig. 18. Enable POR circuit.

V_{EN_FTH} is the falling threshold

V_{EN_RTH} is the rising threshold that you want.

R (Kohm) is the outen resistor that you connect from Enable pin to the GND

Also, you will see an active high voltage will disable the input UVLO function

FEATURES DESCRIPTIONS (CON.)

The ENABLE input can be driven in a variety of ways as shown in Figures 19 and 20. If the ENABLE signal comes from the primary side of the circuit, the ENABLE can be driven through either a bipolar signal transistor (Figure 18). If the enable signal comes from the secondary side, then an opto-coupler or other isolation devices must be used to bring the signal across the voltage isolation (please see Figure 19).

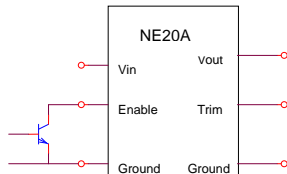

Figure 19: Enable Input drive circuit for NE series

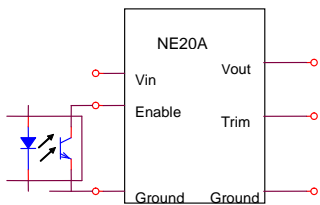

Figure 20: Enable input drive circuit example with isolation.

Input Under-Voltage Lockout

The input under-voltage lockout prevents the converter from being damaged while operating when the input voltage is too low. The lockout occurs between 3.3V to 4.3V.

Over-Current and Short-Circuit Protection

The NE series modules have non-latching over-current and short-circuit protection circuitry. When over current condition occurs, the module goes into the non-latching hiccup mode. When the over-current condition is removed, the module will resume normal operation.

An over current condition is detected by measuring the voltage drop across the MOSFETs. The voltage drop across the MOSFET is also a function of the MOSFET's $R_{ds(on)}$. $R_{ds(on)}$ is affected by temperature, therefore ambient temperature will affect the current limit inception point.

The detection of the $R_{ds(on)}$ of MOSFETs also acts as an over temperature protection since high temperature will cause the $R_{ds(on)}$ of the MOSFETs to increase, eventually triggering over-current protection.

Output Voltage Programming

The output voltage of the NE series is trimmable by connecting an external resistor between the trim pin and output ground as shown Figure 21 and the typical trim resistor values are shown in Table 1.

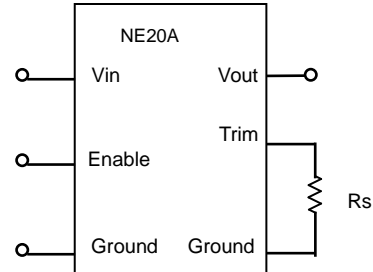

Figure 21: Trimming Output Voltage

The NE20 module has a trim range of 0.59V to 5.0V. The trim resistor equation for the NE20A is:

$$R_s(\Omega) = \frac{1182}{V_{out} - 0.591}$$

V_{out} is the output voltage setpoint
 R_s is the resistance between Trim and Ground
 R_s values should not be less than 240 Ω

Output Voltage	R_s (Ω)
0.59V	open
+1 V	2.9k
+1.5 V	1.3K
+2.5 V	619
+3.3 V	436
+5.0V	268

Table 1: Typical trim resistor values

FEATURES DESCRIPTIONS (CON.)

Voltage Margining Adjustment

Output voltage margin adjusting can be implemented in the NE modules by connecting a resistor, $R_{\text{margin-up}}$, from the Trim pin to the Ground for margining up the output voltage. Also, the output voltage can be adjusted lower by connecting a resistor, $R_{\text{margin-down}}$, from the Trim pin to the voltage source V_t . Figure 22 shows the circuit configuration for output voltage margining adjustment.

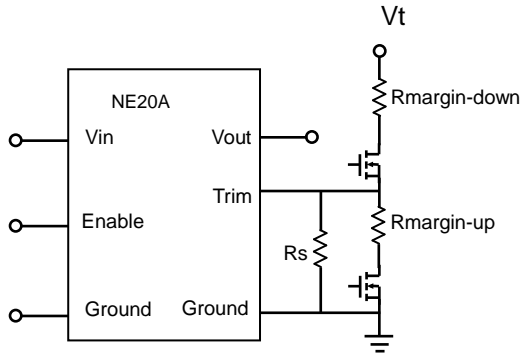

Figure 22: Circuit configuration for output voltage margining

Paralleling

NE20 converters do not have built-in current sharing (paralleling) ability. Hence, paralleling of multiple NE20 converter is not recommended.

Output Capacitance

There is internal output capacitor on the NE series modules. Hence, no external output capacitor is required for stable operation.

Reflected Ripple Current and Output Ripple and Noise Measurement

The measurement set-up outlined in Figure 23 has been used for both input reflected/ terminal ripple current and output voltage ripple and noise measurements on NE series converters.

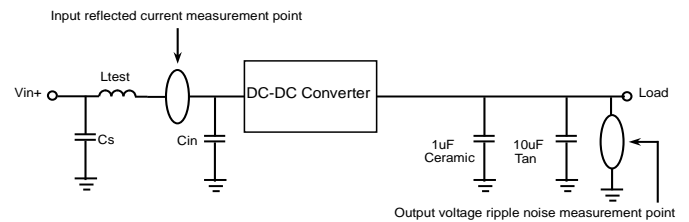

$C_s=270\mu\text{F}^*1$, $L_{\text{test}}=2\mu\text{H}$, $C_{\text{in}}=270\mu\text{F}^*1$

Figure 23: Input reflected ripple/ capacitor ripple current and output voltage ripple and noise measurement setup for NE20



THERMAL CONSIDERATION

Thermal management is an important part of the system design. To ensure proper, reliable operation, sufficient cooling of the power module is needed over the entire temperature range of the module. Convection cooling is usually the dominant mode of heat transfer.

Hence, the choice of equipment to characterize the thermal performance of the power module is a wind tunnel.

Thermal Testing Setup

Delta's DC/DC power modules are characterized in heated vertical wind tunnels that simulate the thermal environments encountered in most electronics equipment. This type of equipment commonly uses vertically mounted circuit cards in cabinet racks in which the power modules are mounted.

The following figure shows the wind tunnel characterization setup. The power module is mounted on a test PWB and is vertically positioned within the wind tunnel. The space between the neighboring PWB and the top of the power module is constantly kept at 6.35mm (0.25").

Thermal Derating

Heat can be removed by increasing airflow over the module. To enhance system reliability, the power module should always be operated below the maximum operating temperature. If the temperature exceeds the maximum module temperature, reliability of the unit may be affected.

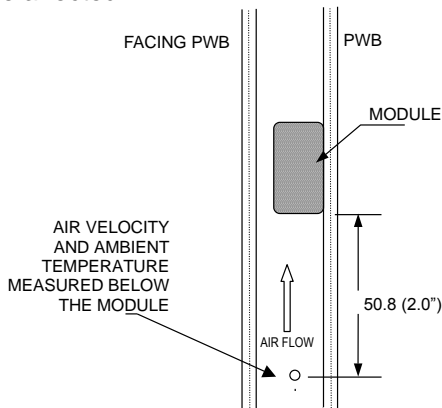

Note: Wind tunnel test setup figure dimensions are in millimeters and (Inches)

Figure 24: Wind tunnel test setup

DS_NE12S20A_08042011

THERMAL CURVES (NE12S0A0V20)

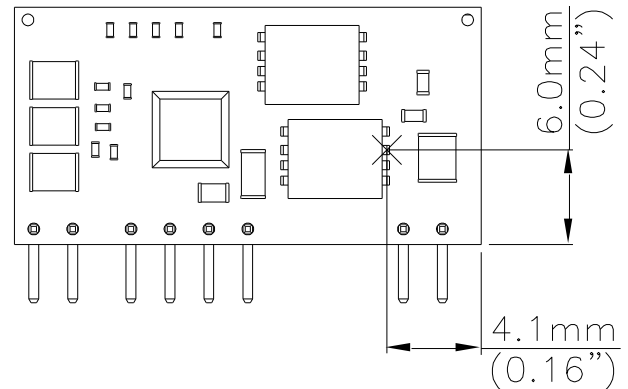

Figure 25: Temperature measurement location* The allowed maximum hot spot temperature is defined at 130 °C

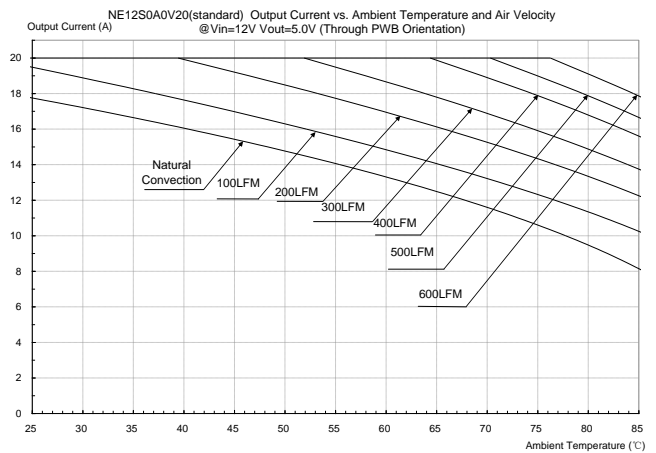

Figure 26: Output current vs. ambient temperature and air velocity @ Vin=12V, Vout=5.0V (Through PWB Orientation)

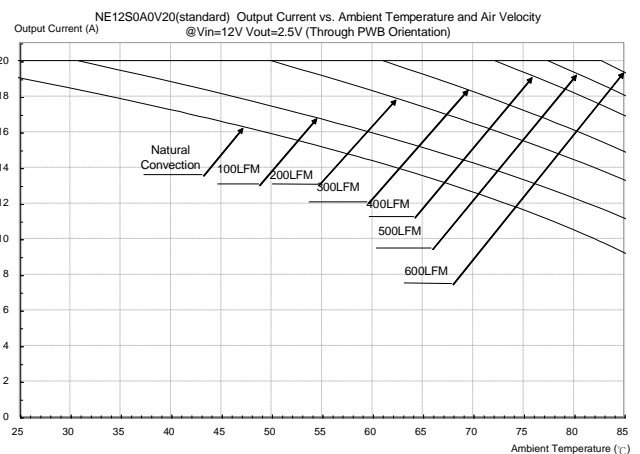

Figure 27: Output current vs. ambient temperature and air velocity @ Vin=12V, Vout=2.5V (Through PWB Orientation)



THERMAL CURVES (NE12S0A0V20)

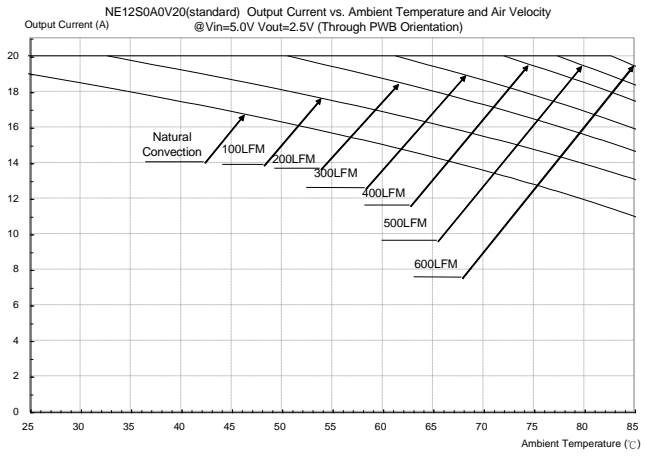

Figure 28: Output current vs. ambient temperature and air velocity @ Vin=5.0V, Vout=2.5V (Through PWB Orientation)

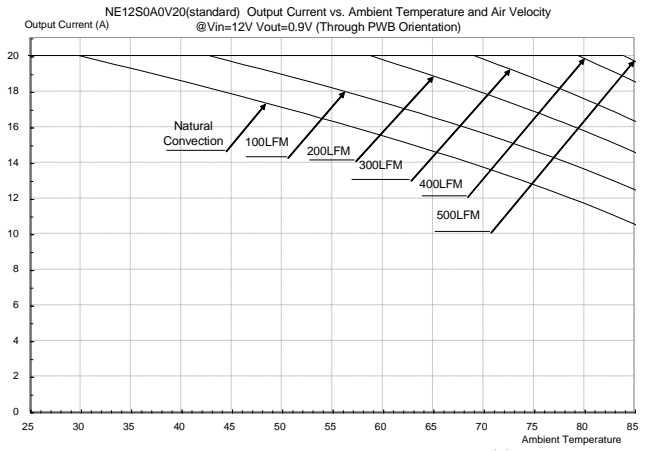

Figure 29: Output current vs. ambient temperature and air velocity @ Vin=12V, Vout=0.9V (Through PWB Orientation)

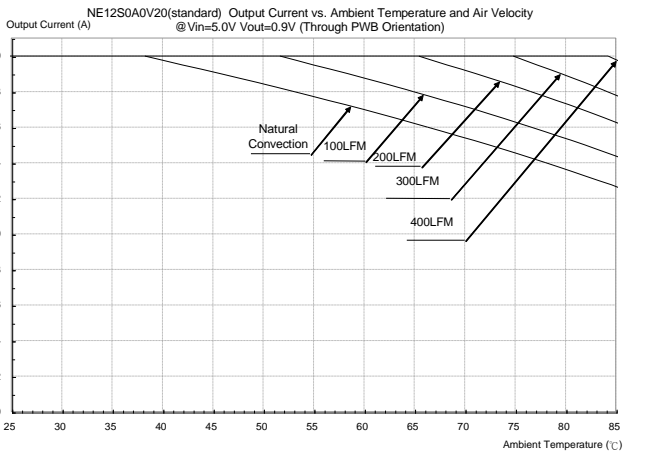
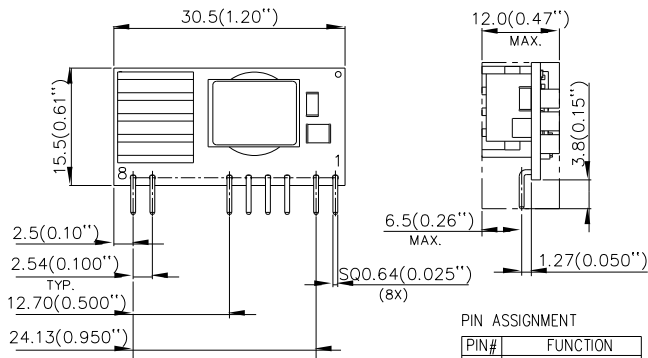

Figure 30: Output current vs. ambient temperature and air velocity @ Vin=5.0V, Vout=0.9V (Through PWB Orientation)



MECHANICAL DRAWING

VERTICAL



PIN ASSIGNMENT

PIN#	FUNCTION
1	Vout
2	Trim
3	Ground
4	Power Good
5	Enable
6	Vin
7	Remote Sense(+)
8	Remote Sense(-)

HORIZONTAL

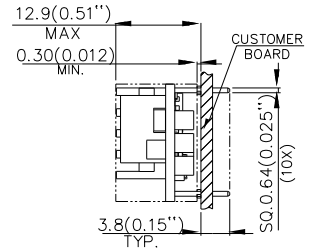
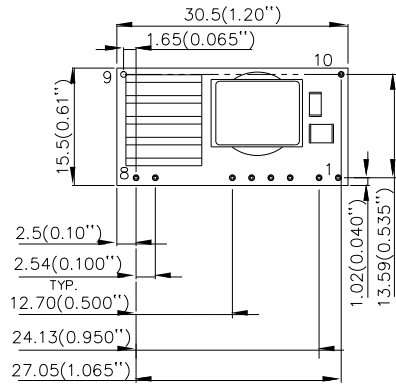

PIN ASSIGNMENT

PIN#	FUNCTION
1	Vout
2	Trim
3	Ground
4	Power Good
5	Enable
6	Vin
7	Remote Sense(+)
8	Remote Sense(-)
9	Mech. Support
10	Mech. Support

NOTES:

DIMENSIONS ARE IN MILLIMETERS AND (INCHS)

TOLERANCE: X.X mm±0.5 mm(X.XX in.±0.02 in.)

X.XX mm±0.25 mm(X.XXX in.±0.010 in.)

PART NUMBERING SYSTEM

NE	12	S	0A0	V	20	P	N	F	A
Product Series	Input Voltage	Number of outputs	Output Voltage	Mounting	Output Current	ON/OFF Logic	Pin Length		Option Code
NE-Non-isolated Series	12- 4.5~13.8V	S- Single output	0A0 - programmable	V- Vertical	20-20A	P- Positive N- Negative	N- 0.150"	F- RoHS 6/6 (Lead Free)	A-standard function

MODEL LIST

Model Name	Packaging	Input Voltage	Output Voltage	Output Current	Efficiency 12Vin @ 100% load
NE12S0A0V20PNFA	Vertical	4.5V~ 13.8Vdc	0.59V~ 5.1Vdc	20A	94.0%@5Vout

CONTACT: www.deltaww.com/dcdc

USA:

Telephone:
East Coast: 978-656-3993
West Coast: 510-668-5100
Fax: (978) 656 3964
Email: DCDC@delta-corp.com

Europe:

Telephone: +31-20-655-0967
Fax: +31-20-655-0999
Email: DCDC@delta-es.com

Asia & the rest of world:

Telephone: +886 3 4526107
Ext. 6220~6224
Fax: +886 3 4513485
Email: DCDC@delta.com.tw

WARRANTY

Delta offers a two (2) year limited warranty. Complete warranty information is listed on our web site or is available upon request from Delta.

Information furnished by Delta is believed to be accurate and reliable. However, no responsibility is assumed by Delta for its use, nor for any infringements of patents or other rights of third parties, which may result from its use. No license is granted by implication or otherwise under any patent or patent rights of Delta. Delta reserves the right to revise these specifications at any time, without notice.