



**ATTENTION**  
OBSERVE PRECAUTIONS  
FOR HANDLING  
ELECTROSTATIC  
DISCHARGE  
SENSITIVE  
DEVICES

Part Number: APGA1602VBC/F-5MAV

Blue

### Features

- 1.6mmx0.9mm right angle SMT LED,0.2mm thickness.
- Low power consumption.
- Wide viewing angle.
- Ideal for backlight and indicator.
- Moisture sensitivity level : level 3.
- Package :2000pcs / reel.
- Tinned pads for improved solderability.
- Low current IF=5mA operating.
- RoHS compliant.

### Description

The Blue source color devices are made with InGaN on Sapphire-substrate Light Emitting Diode. Static electricity and surge damage the LEDs. It is recommended to use a wrist band or anti-electrostatic glove when handling the LEDs. All devices, equipment and machinery must be electrically grounded.

### Package Dimensions

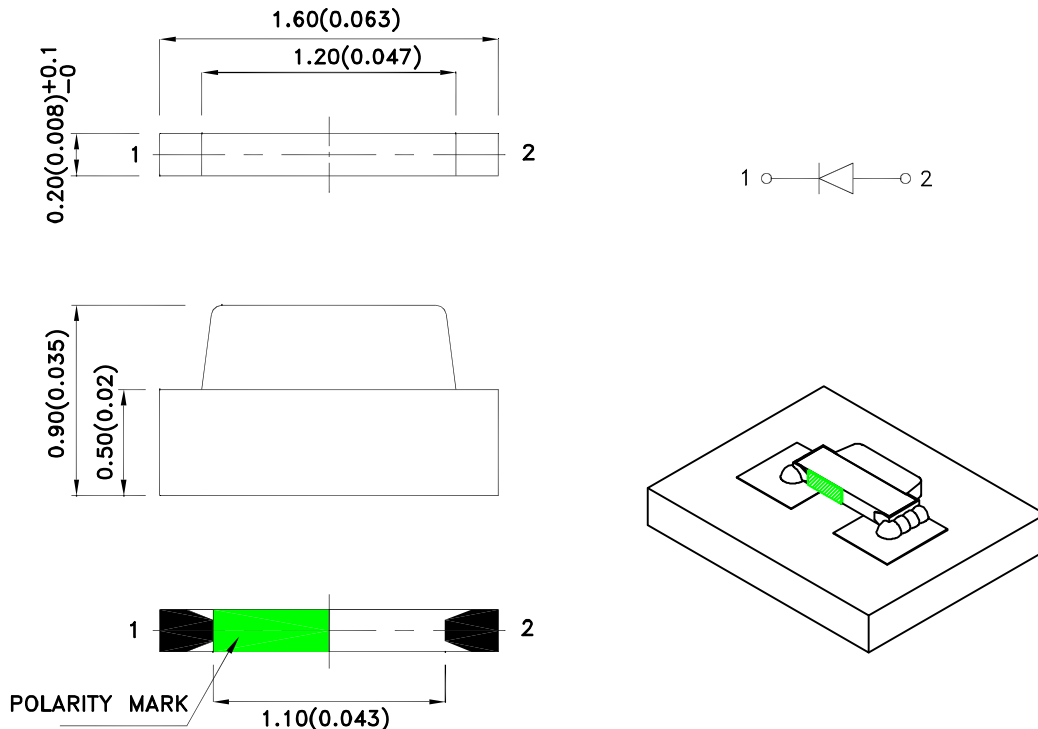

Notes:

1. All dimensions are in millimeters (inches).
2. Tolerance is  $\pm 0.1(0.004)$  unless otherwise noted.
3. The specifications, characteristics and technical data described in the datasheet are subject to change without prior notice.
4. The device has a single mounting surface. The device must be mounted according to the specifications.



## Selection Guide

Part No.	Dice	Lens Type	Iv (mcd) [2] @ 5mA		Viewing Angle [1]
			Min.	Typ.	θ1/2
APGA1602VBC/F-5MAV	Blue (InGaN)	Water Clear	12	25	155°(H) 150°(V)

Notes:

- θ1/2 is the angle from optical centerline where the luminous intensity is 1/2 of the optical peak value.
- Luminous intensity/ luminous Flux: +/-15%.
- Luminous intensity value is traceable to the CIE127-2007 compliant national standards.

## Electrical / Optical Characteristics at TA=25°C

Symbol	Parameter	Device	Typ.	Max.	Units	Test Conditions
$\lambda_{peak}$	Peak Wavelength	Blue	458		nm	IF=5mA
$\lambda_D$ [1]	Dominant Wavelength	Blue	463		nm	IF=5mA
$\Delta\lambda_{1/2}$	Spectral Line Half-width	Blue	25		nm	IF=5mA
$V_F$ [2]	Forward Voltage	Blue	2.8	3.2	V	IF=5mA
$I_R$	Reverse Current	Blue		50	uA	VR=5V

Notes:

- Wavelength: +/-1nm.
- Forward Voltage: +/-0.1V.
- Wavelength value is traceable to the CIE127-2007 compliant national standards.

## Absolute Maximum Ratings at TA=25°C

Parameter	Blue	Units
Power dissipation	100	mW
DC Forward Current	30	mA
Peak Forward Current [1]	150	mA
Reverse Voltage	5	V
Operating Temperature	-40°C To +85°C	
Storage Temperature	-40°C To +100°C	

Note:

- 1/10 Duty Cycle, 0.1ms Pulse Width.

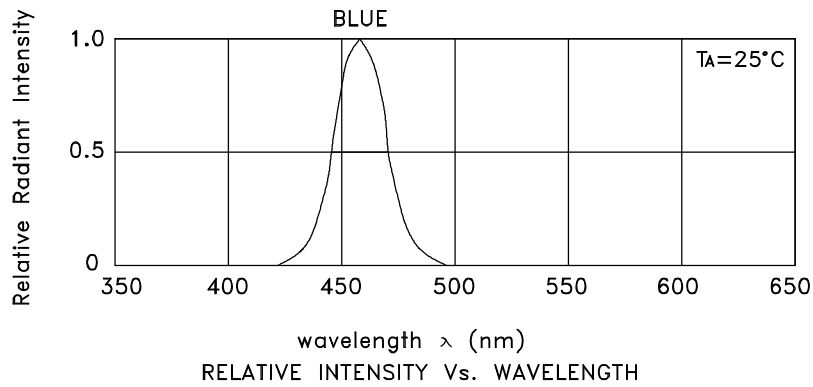

**Blue**

**APGA1602VBC/F-5MAV**

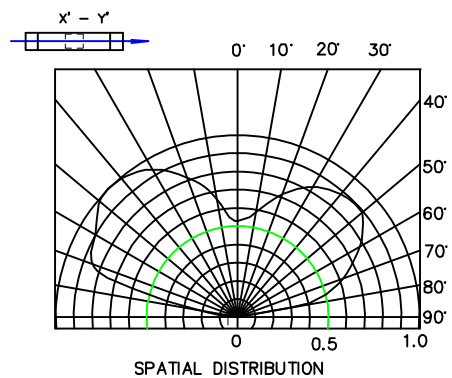
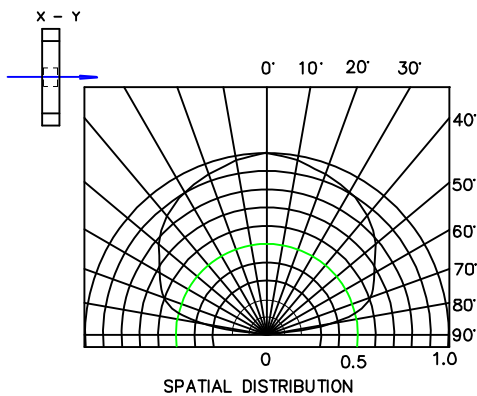
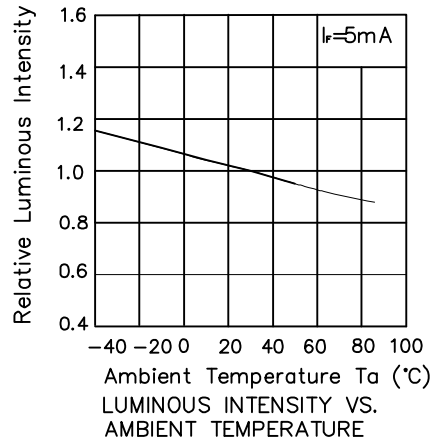
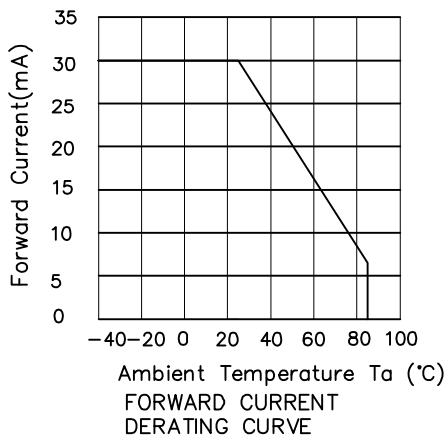
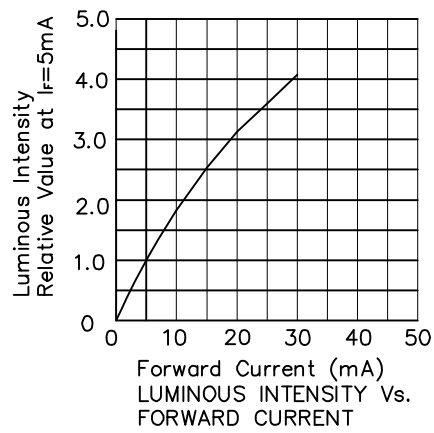
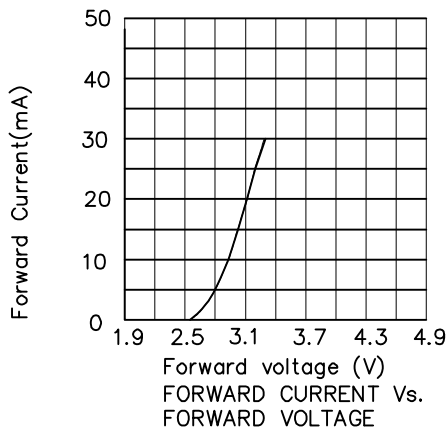

## APGA1602VBC/F-5MAV

Reflow soldering is recommended and the soldering profile is shown below.  
Other soldering methods are not recommended as they might cause damage to the product.

Reflow Soldering Profile For Lead-free SMT Process.

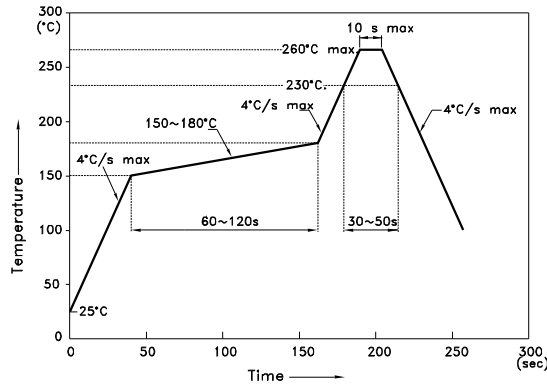

NOTES:

1. We recommend the reflow temperature 245°C(+/-5°C). The maximum soldering temperature should be limited to 260°C.
2. Don't cause stress to the epoxy resin while it is exposed to high temperature.
3. Number of reflow process shall be 2 times or less.

### Recommended Soldering Pattern (Units : mm; Tolerance: ± 0.1)

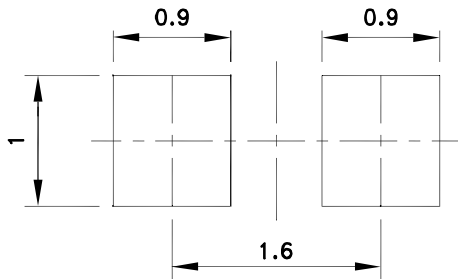

### Reel Dimension

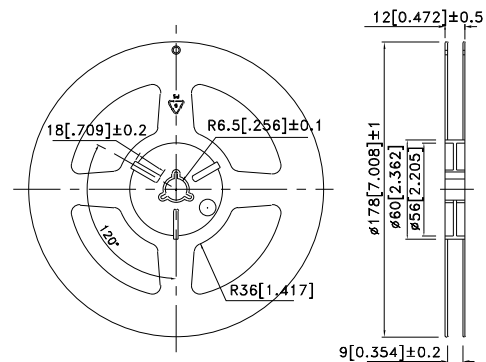

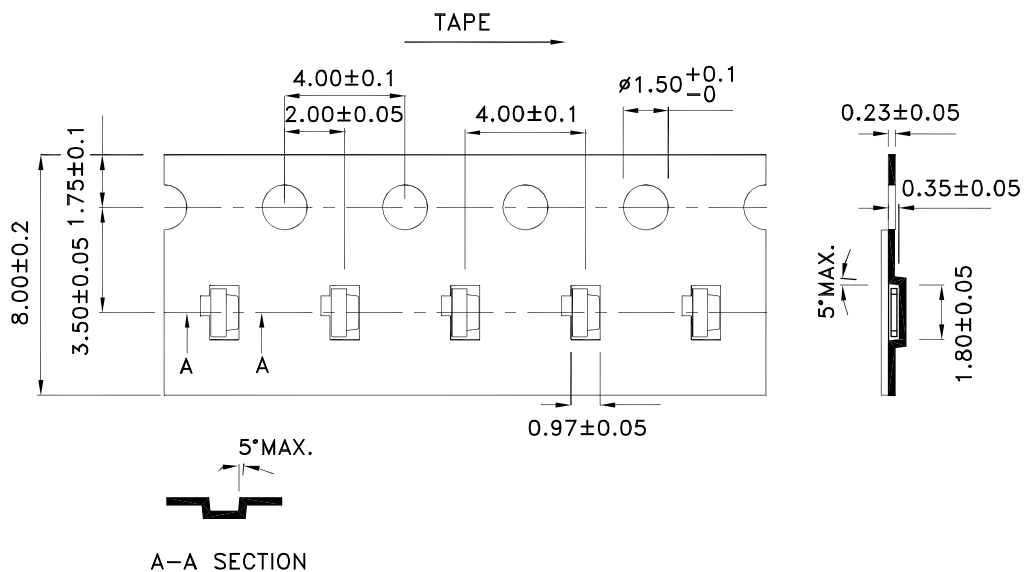

### Tape Dimensions (Units : mm)

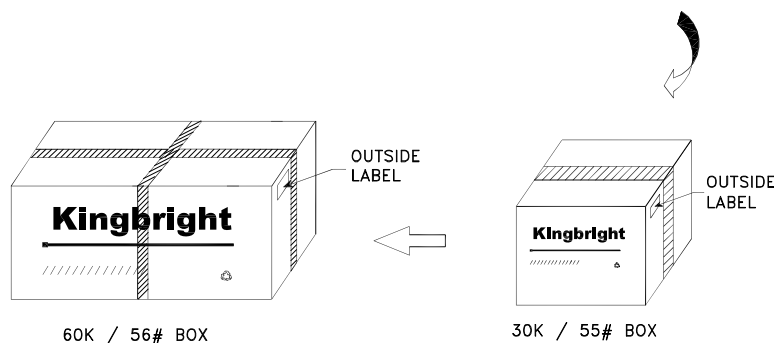
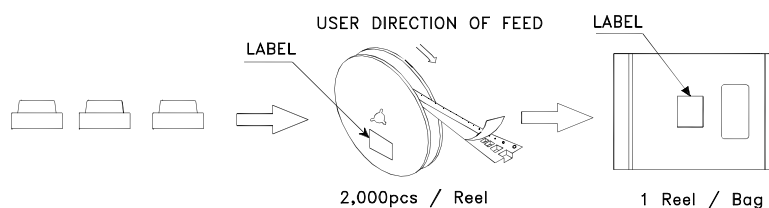

## PACKING & LABEL SPECIFICATIONS

## APGA1602VBC/F-5MAV



<b>Kingbright</b>		
P/NO: APGA1602xxx		
QTY: 2,000 pcs	Q.C.	Q C XX XX XXXX PASSED
S/N: XXXX		
CODE: XXX		
LOT NO:		
		
RoHS Compliant		

### Terms and conditions for the usage of this document

- 1.The information included in this document reflects representative usage scenarios and is intended for technical reference only.
- 2.The part number, type, and specifications mentioned in this document are subject to future change and improvement without notice. Before production usage customer should refer to the latest datasheet for the updated specifications.
- 3.When using the products referenced in this document, please make sure the product is being operated within the environmental and electrical limits specified in the datasheet. If customer usage exceeds the specified limits, Kingbright will not be responsible for any subsequent issues.
- 4.The information in this document applies to typical usage in consumer electronics applications. If customer's application has special reliability requirements or have life-threatening liabilities, such as automotive or medical usage, please consult with Kingbright representative for further assistance.
- 5.The contents and information of this document may not be reproduced or re-transmitted without permission by Kingbright.
- 6.All design applications should refer to Kingbright application notes available at <http://www.KingbrightUSA.com/ApplicationNotes>