

EPC2216 – Automotive 15 V (D-S) Enhancement Mode Power Transistor

 $V_{DS}, 15\text{ V}$
 $R_{DS(on)}, 26\text{ m}\Omega$
 $I_D, 3.4\text{ A}$

AEC-Q101

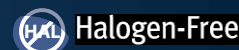

Gallium Nitride's exceptionally high electron mobility and low temperature coefficient allows very low $R_{DS(on)}$, while its lateral device structure and majority carrier diode provide exceptionally low Q_G and zero Q_{RR} . The end result is a device that can handle tasks where very high switching frequency, and low on-time are beneficial as well as those where on-state losses dominate.

Maximum Ratings

PARAMETER		VALUE	UNIT
V_{DS}	Drain-to-Source Voltage (Continuous)	15	V
	Drain-to-Source Voltage (up to 10,000 5 ms pulses at 150°C)	18	
I_D	Continuous ($T_A = 25^\circ\text{C}$)	3.4	A
	Pulsed (25°C, $T_{PULSE} = 300\ \mu\text{s}$)	28	
V_{GS}	Gate-to-Source Voltage	6	V
	Gate-to-Source Voltage	-4	
T_J	Operating Temperature	-40 to 150	°C
T_{STG}	Storage Temperature	-40 to 150	

Thermal Characteristics

PARAMETER		TYP	UNIT
$R_{\theta JC}$	Thermal Resistance, Junction-to-Case	5.7	°C/W
$R_{\theta JB}$	Thermal Resistance, Junction-to-Board	39	
$R_{\theta JA}$	Thermal Resistance, Junction-to-Ambient (Note 1)	97	

Note 1: $R_{\theta JA}$ is determined with the device mounted on one square inch of copper pad, single layer 2 oz copper on FR4 board. See https://epc-co.com/epc/documents/product-training/Appnote_Thermal_Performance_of_eGaN_FETs.pdf for details

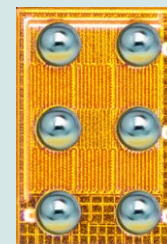

EPC2216 eGaN® FETs are supplied only in passivated die form with solder bumps
Die Size: 0.85 mm x 1.2 mm

Applications

- High Speed DC-DC conversion
- Lidar/Pulsed Power Applications
- Lidar for Augmented Reality Applications

Benefits

- Ultra High Efficiency
- Ultra Low $R_{DS(on)}$
- Ultra Low Q_G
- Ultra Small Footprint

Static Characteristics ($T_J = 25^\circ\text{C}$ unless otherwise stated)

PARAMETER		TEST CONDITIONS	MIN	TYP	MAX	UNIT
BV_{DSS}	Drain-to-Source Voltage	$V_{GS} = 0\text{ V}, I_D = 0.1\text{ mA}$	15			V
I_{DSS}	Drain-Source Leakage	$V_{DS} = 15\text{ V}, V_{GS} = 0\text{ V}, T_J = 25^\circ\text{C}$		0.01	0.1	mA
I_{GSS}	Gate-to-Source Forward Leakage	$V_{GS} = 5\text{ V}, T_J = 25^\circ\text{C}$		0.004	0.5	mA
	Gate-to-Source Forward Leakage [#]	$V_{GS} = 5\text{ V}, T_J = 125^\circ\text{C}$		0.02	1	mA
	Gate-to-Source Reverse Leakage	$V_{GS} = -4\text{ V}, T_J = 25^\circ\text{C}$		0.01	0.1	mA
$V_{GS(TH)}$	Gate Threshold Voltage	$V_{DS} = V_{GS}, I_D = 1\text{ mA}$	0.7	1	2.5	V
$R_{DS(on)}$	Drain-Source On Resistance	$V_{GS} = 5\text{ V}, I_D = 1.5\text{ A}$		20	26	mΩ
V_{SD}	Source-Drain Forward Voltage	$I_S = 0.5\text{ A}, V_{GS} = 0\text{ V}$		1.9		V

[#] Defined by design. Not subject to production test.

All measurements were done with substrate connected to source.

Dynamic Characteristics ($T_J = 25^\circ\text{C}$ unless otherwise stated)

PARAMETER		TEST CONDITIONS	MIN	TYP	MAX	UNIT
C_{ISS}	Input Capacitance [#]	$V_{DS} = 7.5\text{ V}, V_{GS} = 0\text{ V}$		98	118	pF
C_{RSS}	Reverse Transfer Capacitance			20		
C_{OSS}	Output Capacitance [#]			66	99	
$C_{OSS(ER)}$	Effective Output Capacitance, Energy Related (Note 2)	$V_{DS} = 0\text{ to }7.5\text{ V}, V_{GS} = 0\text{ V}$		69		
$C_{OSS(TR)}$	Effective Output Capacitance, Time Related (Note 3)			71		
R_G	Gate Resistance			0.5		Ω
Q_G	Total Gate Charge [#]	$V_{DS} = 7.5\text{ V}, V_{GS} = 5\text{ V}, I_D = 1.5\text{ A}$		0.87	1.1	nC
Q_{GS}	Gate-to-Source Charge	$V_{DS} = 7.5\text{ V}, I_D = 1.5\text{ A}$		0.21		
Q_{GD}	Gate-to-Drain Charge			0.13		
$Q_{G(TH)}$	Gate Charge at Threshold			0.16		
Q_{OSS}	Output Charge [#]	$V_{DS} = 7.5\text{ V}, V_{GS} = 0\text{ V}$		0.53	0.8	
Q_{RR}	Source-Drain Recovery Charge			0		

Defined by design. Not subject to production test.

Note 2: $C_{OSS(ER)}$ is a fixed capacitance that gives the same stored energy as C_{OSS} while V_{DS} is rising from 0 to 50% BV_{DSS} .

Note 3: $C_{OSS(TR)}$ is a fixed capacitance that gives the same charging time as C_{OSS} while V_{DS} is rising from 0 to 50% BV_{DSS} .

Figure 1: Typical Output Characteristics at 25°C

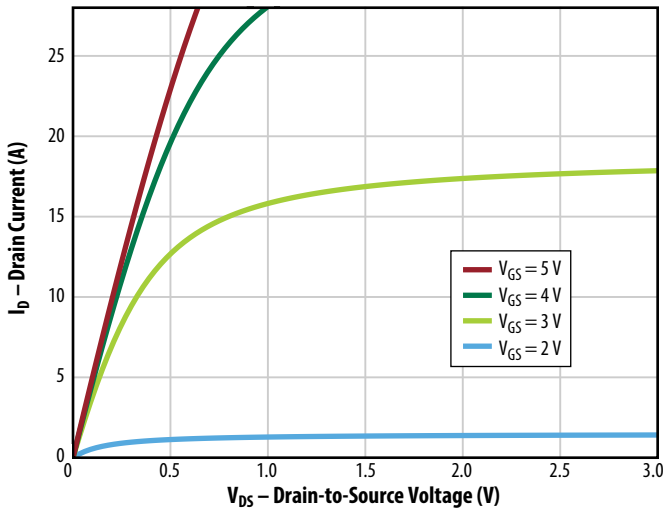

Figure 2: Transfer Characteristics

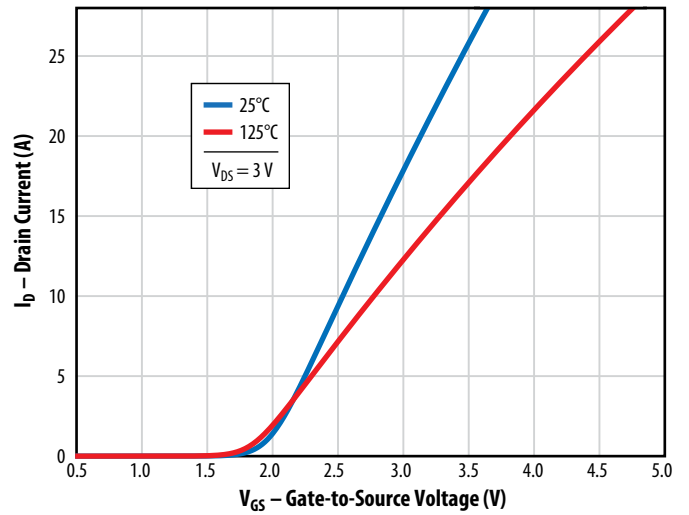

Figure 3: $R_{DS(on)}$ vs. V_{GS} for Various Drain Currents

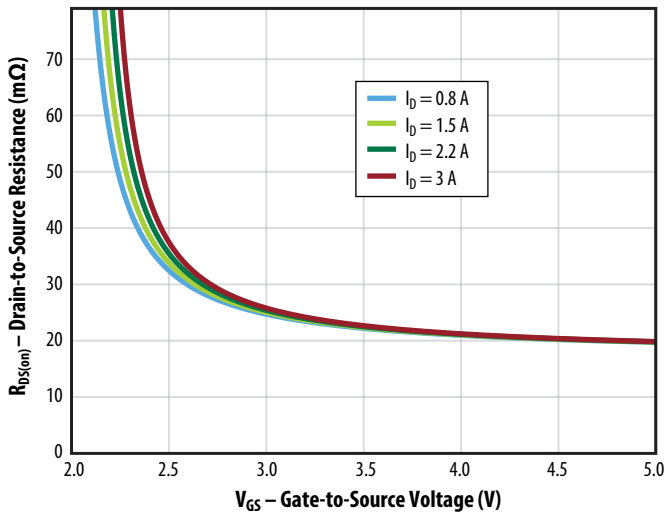

Figure 4: $R_{DS(on)}$ vs. V_{GS} for Various Temperatures

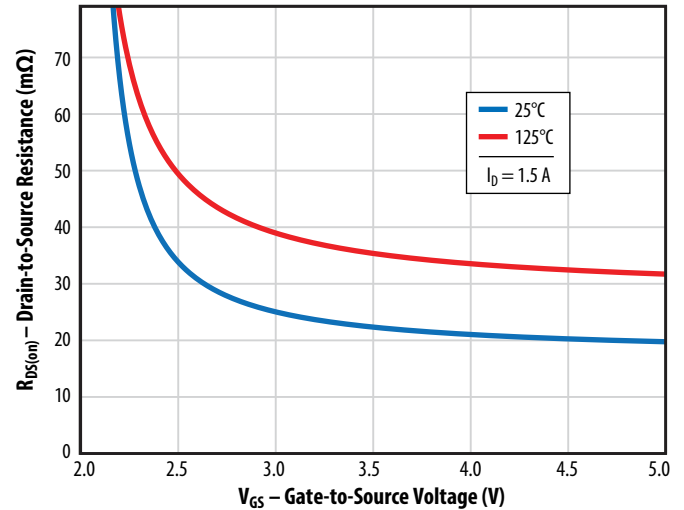

Figure 5a: Capacitance (Linear Scale)

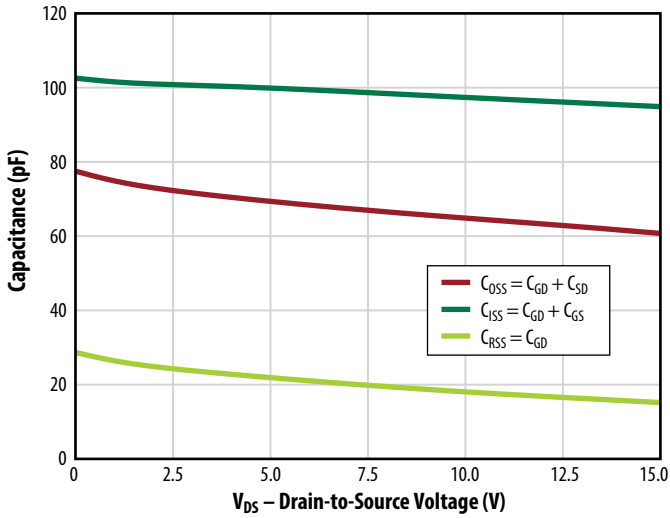

Figure 5b: Capacitance (Log Scale)

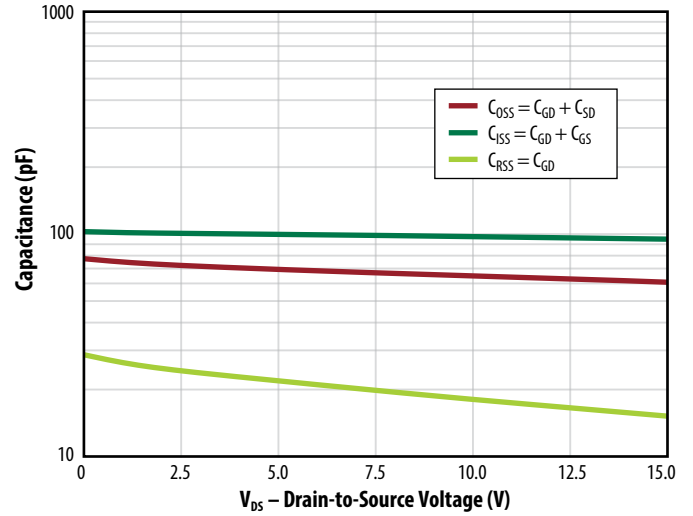

Figure 6: Output Charge and C_{OSS} Stored Energy

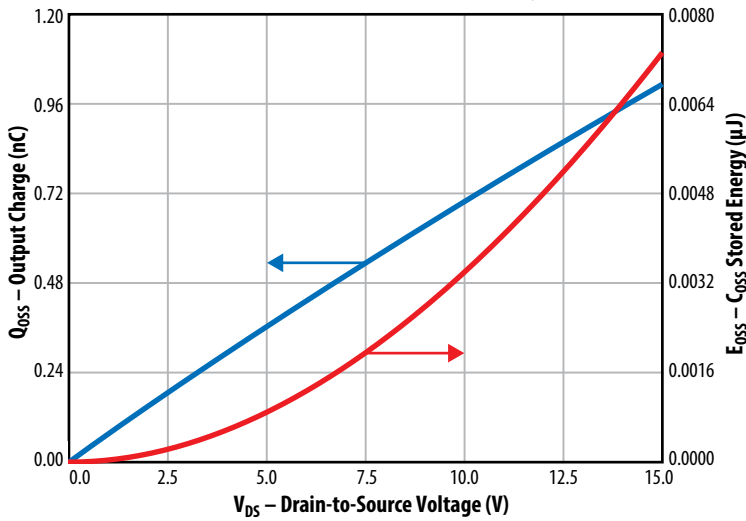

Figure 7: Gate Charge

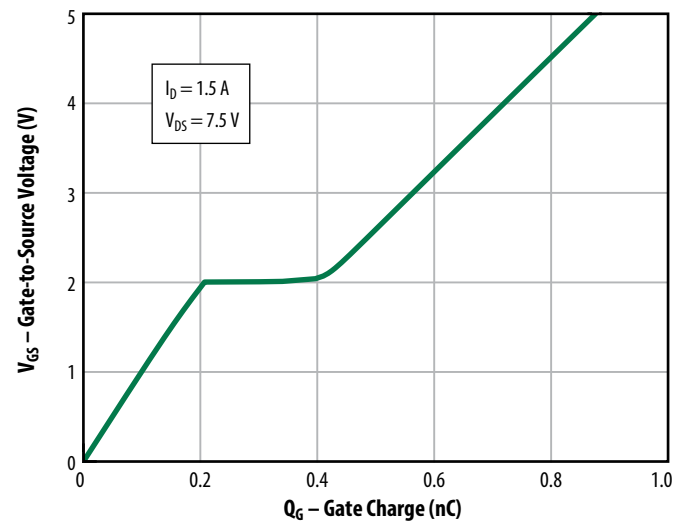

Figure 8: Reverse Drain-Source Characteristics

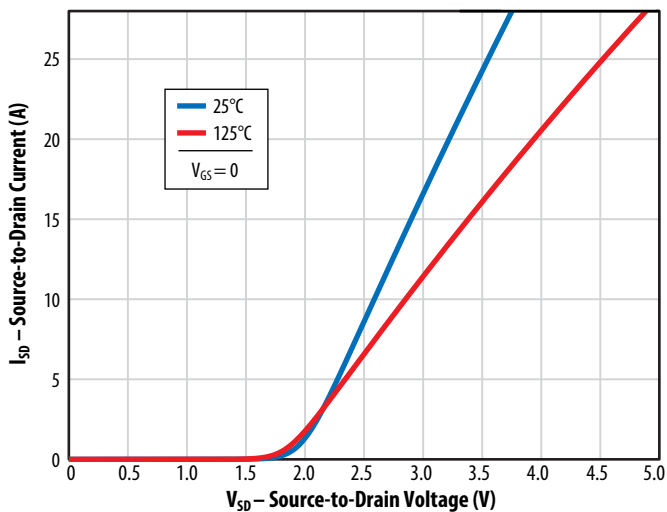
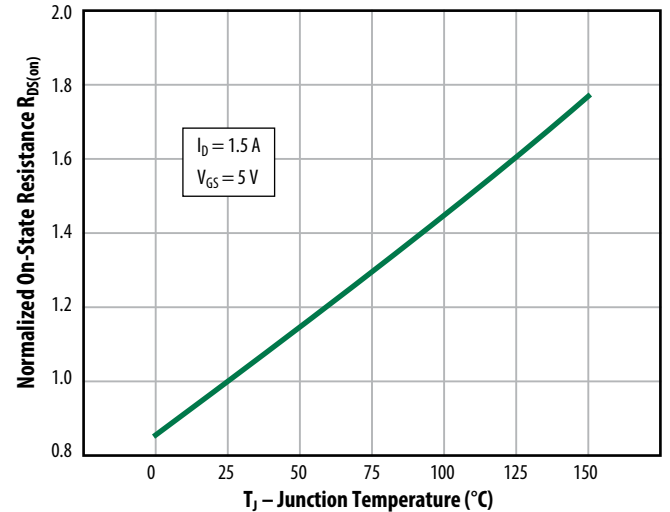

Figure 9: Normalized On-State Resistance vs. Temperature



All measurements were done with substrate shorted to source.

Figure 10: Normalized Threshold Voltage vs. Temperature

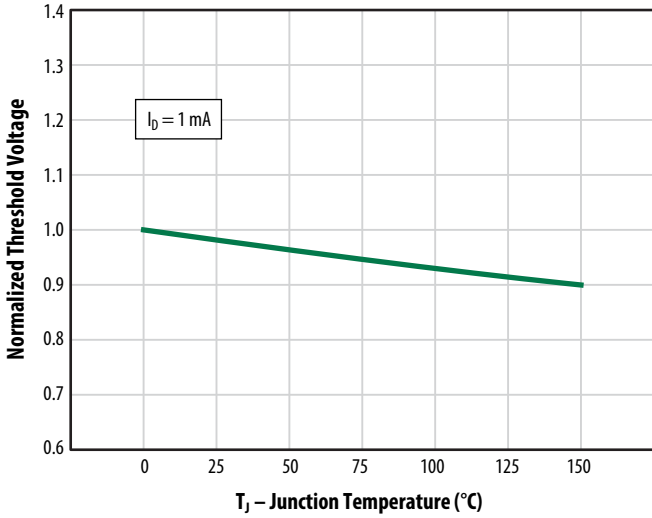

Figure 11: Safe Operating Area

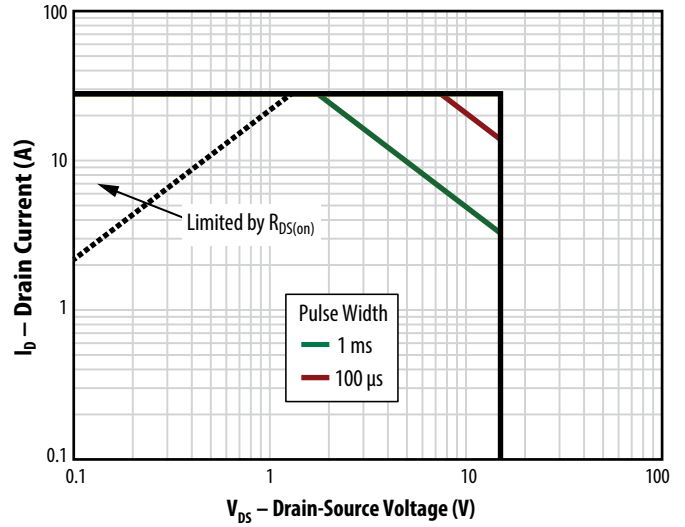
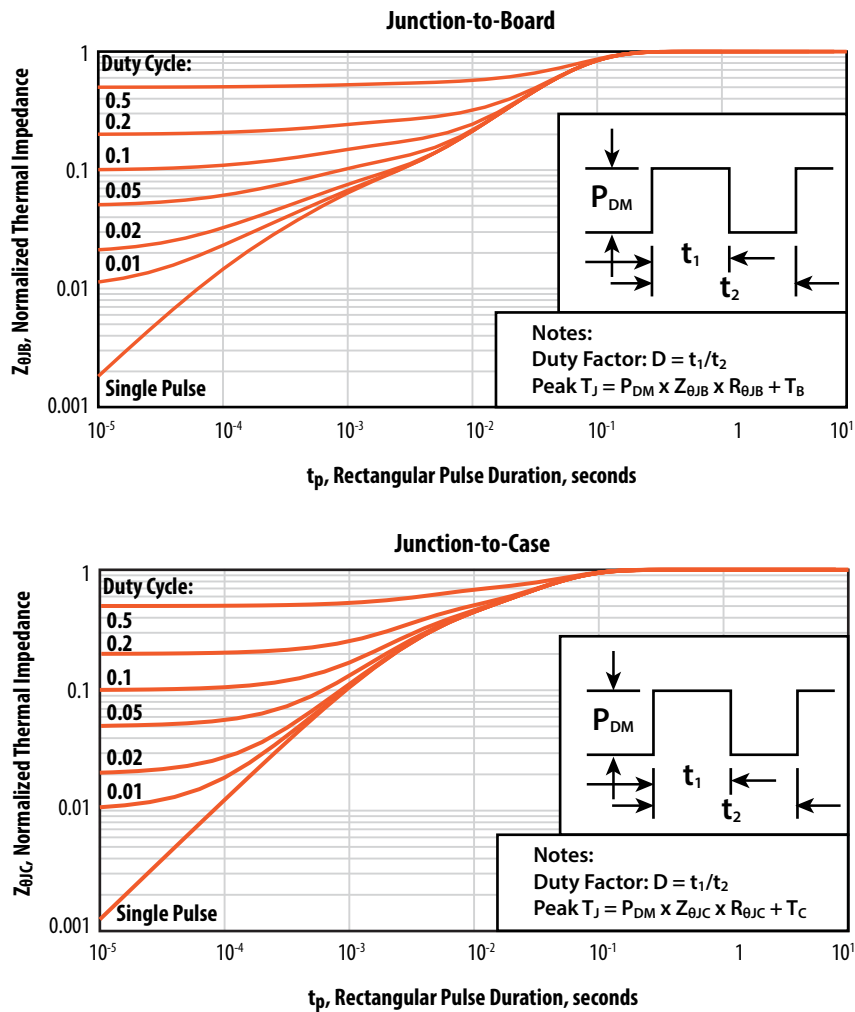
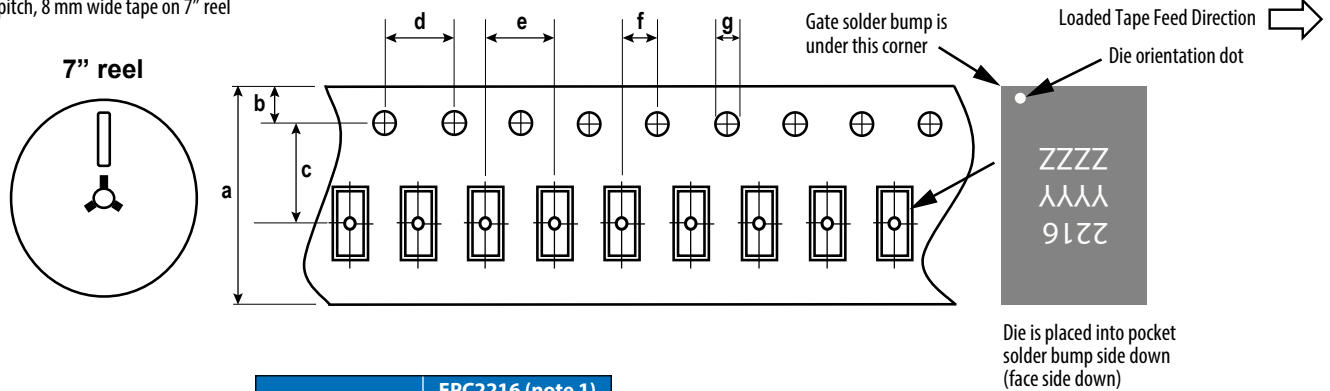

Figure 12: Transient Thermal Response Curves



TAPE AND REEL CONFIGURATION

4 mm pitch, 8 mm wide tape on 7" reel



Dimension (mm)	EPC2216 (note 1)		
	target	min	max
a	8.00	7.90	8.30
b	1.75	1.65	1.85
c (note 2)	3.50	3.45	3.55
d	4.00	3.90	4.10
e	4.00	3.90	4.10
f (note 2)	2.00	1.95	2.05
g	1.5	1.5	1.6

Note 1: MSL 1 (moisture sensitivity level 1) classified according to IPC/JEDEC industry standard.
 Note 2: Pocket position is relative to the sprocket hole measured as true position of the pocket, not the pocket hole.

DIE MARKINGS

Part Number	Laser Markings		
	Part # Marking Line 1	Lot_Date Code Marking line 2	Lot_Date Code Marking line 3
EPC2216	2216	YYYY	ZZZZ

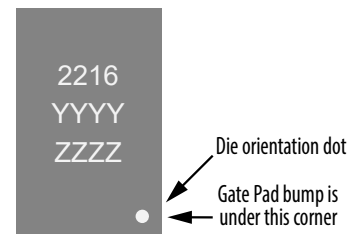

DIE OUTLINE
Solder Bump View

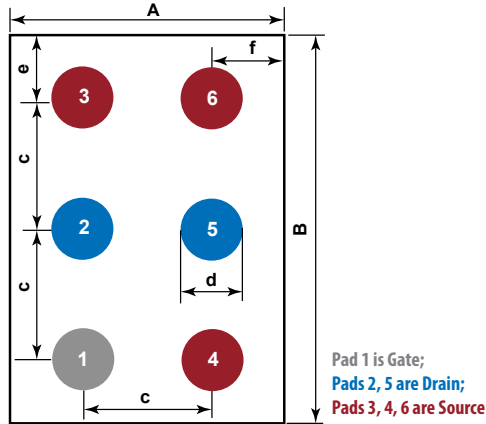

DIM	Micrometers		
	MIN	Nominal	MAX
A	820	850	880
B	1170	1200	1230
c		400	
d	187	208	229
e	185	200	215
f	210	225	240

Side View

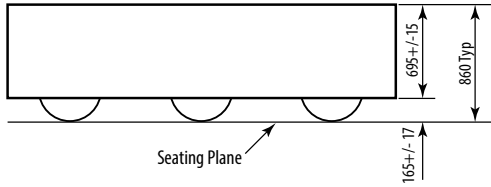

RECOMMENDED LAND PATTERN
(measurements in μm)

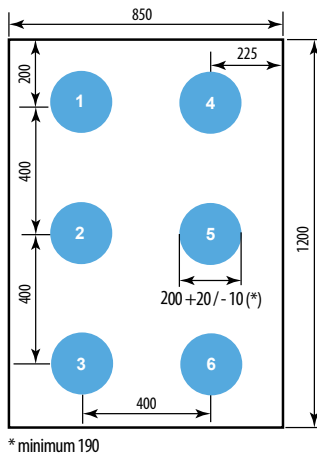

The land pattern is solder mask defined
Solder mask is 10 μm smaller per side than bump

Pad 1 is Gate;
Pads 2, 5 are Drain;
Pads 3, 4, 6 are Source

RECOMMENDED STENCIL DRAWING
(measurements in μm)

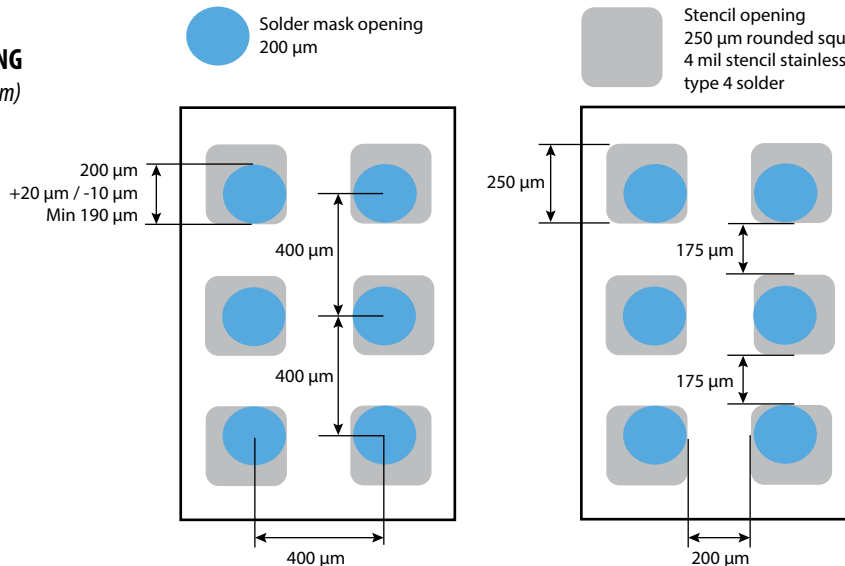

Recommended stencil should be 4 mil (100 μm) thick, must be laser cut, openings per drawing.

Intended for use with SAC305 Type 4 solder, reference 88.5% metals content.

Additional assembly resources available at <https://epc-co.com/epc/DesignSupport/AssemblyBasics.aspx>

Efficient Power Conversion Corporation (EPC) reserves the right to make changes without further notice to any products herein to improve reliability, function or design. EPC does not assume any liability arising out of the application or use of any product or circuit described herein; neither does it convey any license under its patent rights, nor the rights of others.

eGaN® is a registered trademark of Efficient Power Conversion Corporation.
EPC Patent Listing: epc-co.com/epc/AboutEPC/Patents.aspx

Information subject to change without notice.

Revised May, 2020