



E502650

Features

- Low Switching Losses
- Low $V_{ce(sat)}$ with Positive Temperature Coefficient
- Including Fast & Soft Recovery Anti-parallel FWD
- Low Inductance Case
- High Short Circuit Capability(10 μ s)
- Maximum Junction Temperature 175°C
- Epoxy Meets UL 94 V-0 Flammability Rating
- Lead Free Finish/RoHS Compliant ("P" Suffix Designates RoHS Compliant. See Ordering Information)

Applications

- Motor Drivers
- AC and DC Servo Drive Amplifier
- UPS (Uninterruptible Power Supplies)

Circuit Diagram

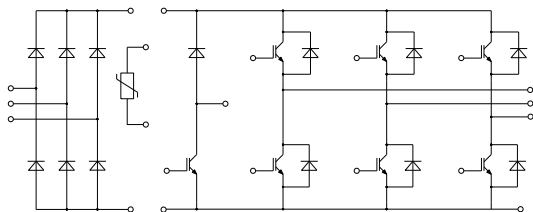

IGBT Modules 1200V 25A

E1

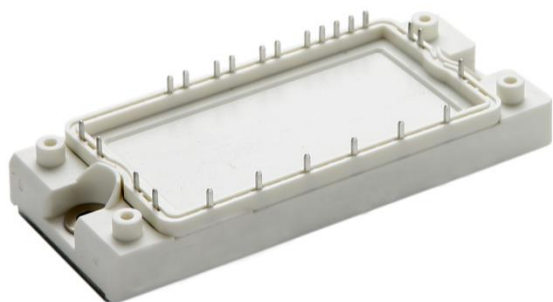
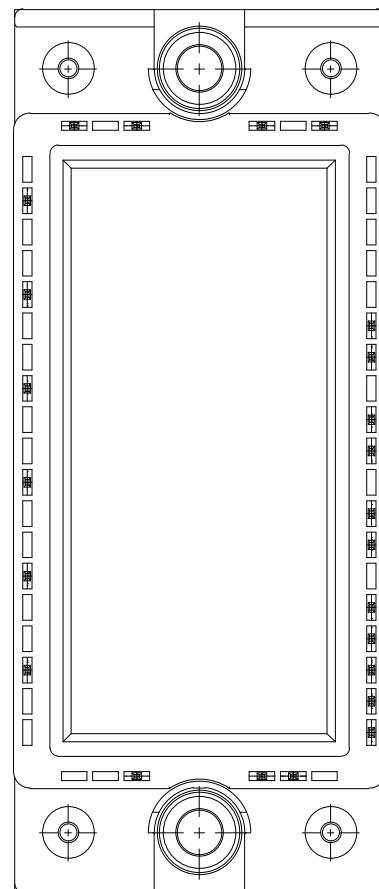
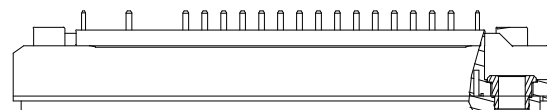

● IGBT- Inverter

Maximum Ratings

Parameter	Symbol	Test Conditions	Rating	Unit
Collector-Emitter Voltage	V_{CES}	$V_{GE}=0V, I_C=1mA, T_{vj}=25^{\circ}C$	1200	V
Continuous Collector Current	I_C	$T_C=100^{\circ}C, T_{vjmax}=175^{\circ}C$	25	A
Repetitive Peak Collector Current	I_{CRM}	$t_p=1ms$	50	A
Gate-Emitter Voltage	V_{GES}	$T_{vj}=25^{\circ}C$	± 20	V
Total Power Dissipation	P_{tot}	$T_C=25^{\circ}C, T_{vjmax}=175^{\circ}C$	166	W

Electrical Characteristics

Parameter	Symbol	Test Conditions	Min	Typ	Max	Unit	
Gate-Emitter Threshold Voltage	$V_{GE(th)}$	$V_{GE}=V_{CE}, I_C=0.8mA, T_{vj}=25^{\circ}C$	5.2	6.0	6.8	V	
Collector-Emitter Cut-off Current	I_{CES}	$V_{CE}=1200V, V_{GE}=0V, T_{vj}=25^{\circ}C$			1	mA	
Collector-Emitter Saturation Voltage	$V_{CE(sat)}$	$I_C=25A, V_{GE}=15V, T_{vj}=25^{\circ}C$		1.85	2.25	V	
		$I_C=25A, V_{GE}=15V, T_{vj}=125^{\circ}C$		2.15		V	
		$I_C=25A, V_{GE}=15V, T_{vj}=150^{\circ}C$		2.25		V	
Gate Charge	Q_g			0.2		μC	
Input Capacitance	C_{ies}	$V_{CE}=25V, V_{GE}=0V, f=1MHz$		1.45		nF	
Reverse Transfer Capacitance	C_{res}			0.05			
Gate-Emitter leakage current	I_{GES}	$V_{CE}=0V, V_{GE}=20V, T_{vj}=25^{\circ}C$			400	nA	
Turn-On Delay Time	$t_{d(on)}$	$V_{CE}=600V, I_C=25A, V_{GE}=\pm 15V, R_G=18\Omega, T_{vj}=25^{\circ}C$		158		ns	
Rise Time	t_r			32			
Turn-Off Delay Time	$t_{d(off)}$			331			
Fall Time	t_f			83			
Turn-On Energy	E_{on}			1.8			mJ
Turn-Off Energy	E_{off}			1.4			
Turn-On Delay Time	$t_{d(on)}$	$V_{CE}=600V, I_C=25A, V_{GE}=\pm 15V, R_G=18\Omega, T_{vj}=125^{\circ}C$		172		ns	
Rise Time	t_r			435			
Turn-Off Delay Time	$t_{d(off)}$			154			
Fall Time	t_f			212			
Turn-On Energy	E_{on}			2.4			mJ
Turn-Off Energy	E_{off}			2.18			
SC Data	I_{SC}	$T_p \leq 10\mu s, V_{GE}=15V, T_{vj}=150^{\circ}C, V_{CC}=900V, V_{CEM} \leq 1200V$		120		A	

● Diode- Inverter

Maximum Ratings

Parameter	Symbol	Test Conditions	Rating	Unit
Repetitive Peak Reverse Voltage	V_{RRM}	$T_{vj}=25^{\circ}C$	1200	V
Continuous DC Forward Current	I_F		25	A
Repetitive Peak Forward Current	I_{FRM}	$t_p=1ms$	50	A
I^2t -value	I^2t	$V_R=0, t_p=10ms, T_{vj}=125^{\circ}C$	90	A^2s
		$V_R=0, t_p=10ms, T_{vj}=150^{\circ}C$	75	

Electrical Characteristics

Parameter	Symbol	Test Conditions	Min	Typ	Max	Unit
Forward Voltage	V_F	$I_F=25A, T_{vj}=25^{\circ}C$		2.1	2.5	V
		$I_F=25A, T_{vj}=125^{\circ}C$		2.2		V
		$I_F=25A, T_{vj}=150^{\circ}C$		2.2		V
Recovered Charge	Q_{rr}	$I_F=25A, V_R=600V,$ $-di_F/dt=680A/\mu s, T_{vj}=25^{\circ}C$		2.52		μC
Peak Reverse Recovery Current	I_{rr}			28.5		A
Reverse Recovery Energy	E_{rec}			0.94		mJ
Recovered Charge	Q_{rr}	$I_F=25A, V_R=600V,$ $-di_F/dt=680A/\mu s, T_{vj}=125^{\circ}C$		50.8		μC
Peak Reverse Recovery Current	I_{rr}			30.5		A
Reverse Recovery Energy	E_{rec}			1.75		mJ

● IGBT- Brake-chopper

Maximum Ratings

Parameter	Symbol	Test Conditions	Rating	Unit
Collector-Emitter Voltage	V_{CES}	$V_{GE}=0V, I_C=1mA, T_{vj}=25^{\circ}C$	1200	V
Continuous Collector Current	I_C	$T_C=100^{\circ}C, T_{vjmax}=175^{\circ}C$	15	A
Repetitive Peak Collector Current	I_{CRM}	$t_p=1ms$	30	A
Gate-Emitter Voltage	V_{GES}	$T_{vj}=25^{\circ}C$	± 20	V
Total Power Dissipation	P_{tot}	$T_C=25^{\circ}C, T_{vjmax}=175^{\circ}C$	155	W

Electrical Characteristics

Parameter	Symbol	Test Conditions	Min	Typ	Max	Unit	
Gate-Emitter Threshold Voltage	$V_{GE(th)}$	$V_{GE}=V_{CE}, I_C=0.5mA, T_{vj}=25^{\circ}C$	5.2	6.0	6.8	V	
Collector-Emitter Cut-off Current	I_{CES}	$V_{CE}=1200V, V_{GE}=0V, T_{vj}=25^{\circ}C$			1	mA	
Collector-Emitter Saturation Voltage	$V_{CE(sat)}$	$I_C=15A, V_{GE}=15V, T_{vj}=25^{\circ}C$		1.85	2.25	V	
		$I_C=15A, V_{GE}=15V, T_{vj}=125^{\circ}C$		2.15		V	
		$I_C=15A, V_{GE}=15V, T_{vj}=150^{\circ}C$		2.25		V	
Gate Charge	Q_g			0.09		μC	
Input Capacitance	C_{ies}	$V_{CE}=25V, V_{GE}=0V, f=1MHz$		1.35		nF	
Reverse Transfer Capacitance	C_{res}			0.08			
Gate-Emitter leakage current	I_{GES}	$V_{CE}=0V, V_{GE}=20V, T_{vj}=25^{\circ}C$			400	nA	
Turn-On Delay Time	$t_{d(on)}$	$V_{CE}=600V, I_C=15A, V_{GE}=\pm 15V, R_G=39\Omega, T_{vj}=25^{\circ}C$		46		ns	
Rise Time	t_r			45			
Turn-Off Delay Time	$t_{d(off)}$			182			
Fall Time	t_f			168			
Turn-On Energy	E_{on}			0.92			mJ
Turn-Off Energy	E_{off}		0.56				
Turn-On Delay Time	$t_{d(on)}$	$V_{CE}=600V, I_C=15A, V_{GE}=\pm 15V, R_G=39\Omega, T_{vj}=125^{\circ}C$		46		ns	
Rise Time	t_r			63			
Turn-Off Delay Time	$t_{d(off)}$			248			
Fall Time	t_f			220			
Turn-On Energy	E_{on}			1.37			mJ
Turn-Off Energy	E_{off}			0.81			
SC Data	I_{SC}		$T_p \leq 10\mu s, V_{GE}=15V, T_{vj}=150^{\circ}C, V_{CC}=900V, V_{CEM} \leq 1200V$		55		

● Diode- Brake-chopper

Maximum Ratings

Parameter	Symbol	Test Conditions	Rating	Unit
Repetitive Peak Reverse Voltage	V_{RRM}	$T_{vj}=25^{\circ}C$	1200	V
Continuous DC Forward Current	I_F		15	A
Repetitive Peak Forward Current	I_{FRM}	$t_p=1ms$	30	A
I^2t -value	I^2t	$V_R=0, t_p=10ms, T_{vj}=125^{\circ}C$	40	A^2s
		$V_R=0, t_p=10ms, T_{vj}=150^{\circ}C$	34	

Electrical Characteristics

Parameter	Symbol	Test Conditions	Min	Typ	Max	Unit
Forward Voltage	V_F	$I_F=15A, T_{vj}=25^{\circ}C$		2.0	2.65	V
		$I_F=15A, T_{vj}=125^{\circ}C$		2.1		V
		$I_F=15A, T_{vj}=150^{\circ}C$		2.1		V
Recovered Charge	Q_{rr}	$I_F=15A, V_R=600V,$ $-di_F/dt=600A/\mu s, T_{vj}=25^{\circ}C$		1.2		μC
Peak Reverse Recovery Current	I_{rr}			13.0		A
Reverse Recovery Energy	E_{rec}			0.37		mJ
Recovered Charge	Q_{rr}	$I_F=15A, V_R=600V,$ $-di_F/dt=550A/\mu s, T_{vj}=125^{\circ}C$		2.4		μC
Peak Reverse Recovery Current	I_{rr}			19.4		A
Reverse Recovery Energy	E_{rec}			0.86		mJ

● Diode- Rectifier

Maximum Ratings

Parameter	Symbol	Test Conditions	Rating	Unit
Repetitive Peak Reverse Voltage	V_{RRM}	$T_j=25^{\circ}\text{C}$	1600	V
Average On-state Current 50/60Hz, sine wave	$I_{F(AV)}$	$T_C=100^{\circ}\text{C}$	35	A
Maximum RMS Current at Rectifier Output	I_{RMSM}	$T_C=100^{\circ}\text{C}$	60	A
Surge Forward Current	I_{FSM}	$V_R=0, t_p=10\text{ms}, T_j=45^{\circ}\text{C}$	320	A
I^2t -value	I^2t	$V_R=0, t_p=10\text{ms}, T_j=45^{\circ}\text{C}$	510	A^2s

Electrical Characteristics

Parameter	Symbol	Test Conditions	Min	Typ	Max	Unit
Diode Forward Voltage	V_F	$I_F=25\text{A}, T_j=150^{\circ}\text{C}$		1.02		V
Reverse Current	I_r	$T_j=125^{\circ}\text{C}, V_R=1600\text{V}$			2	mA

● NTC-Thermistor

Electrical Characteristics

Parameter	Symbol	Test Conditions	Min	Typ	Max	Unit
Rated Resistance	R_{25}			5		k Ω
Deviation of R100	$\Delta R/R$	$T_C=100, R_{100}=493.3\Omega$	-5		5	%
Power Dissipation	P_{25}				20	mW
B-value	$B_{25/50}$	$R_2=R_{25}\exp[B_{25/50}(1/T_2-1/(298.15\text{K}))]$		3375		K

● Module Characteristics($T_C=25^\circ\text{C}$ unless otherwise specified)

Parameter	Symbol	Test Conditions	Min	Typ	Max	Unit
Isolation voltage	V_{isol}	$t=1\text{min}, f=50\text{Hz}$	2500			V
Maximum Junction Temperature	T_{jmax}	Inverter, brake			175	$^\circ\text{C}$
		rectifier			150	
Operating Junction Temperature	$T_{\text{vj op}}$		-40		150	$^\circ\text{C}$
Operating Junction Temperature	T_{stg}		-40		125	$^\circ\text{C}$
Stray Inductance	L_{CE}			60		nH
Module Lead Resistance , Terminal to Chip	$R_{\text{cc'+EE'}}$	TC=25 $^\circ\text{C}$, per switch		4		m Ω
	$R_{\text{AA'+CC'}}$			3		
Thermal Resistance Junction to Case	$R_{\theta\text{j c}}$	per IGBT-inverter			0.90	K/W
		per Diode-inverter			1.2	
		per IGBT-brake-chopper			1.2	
		per Diode-chopper			1.5	
		per Diode-rectifier			1.15	
Thermal Resistance Case to Sink	$R_{\theta\text{cs}}$	per IGBT-inverter		0.33		K/W
		per Diode-inverter		0.46		
		per IGBT-brake-chopper		0.46		
		per Diode-chopper		0.70		
		per Diode-rectifier		0.49		
		per Module		0.02		
Module-to-Sink Torque	M_{S}		3		6	N·m
Weight of Module	G			180		g

Curve Characteristics

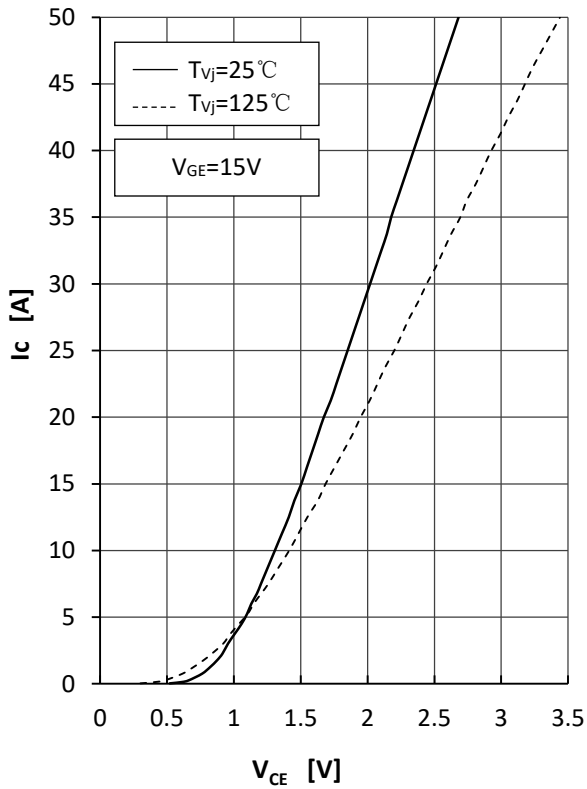

Fig1.IGBT Output Characteristics

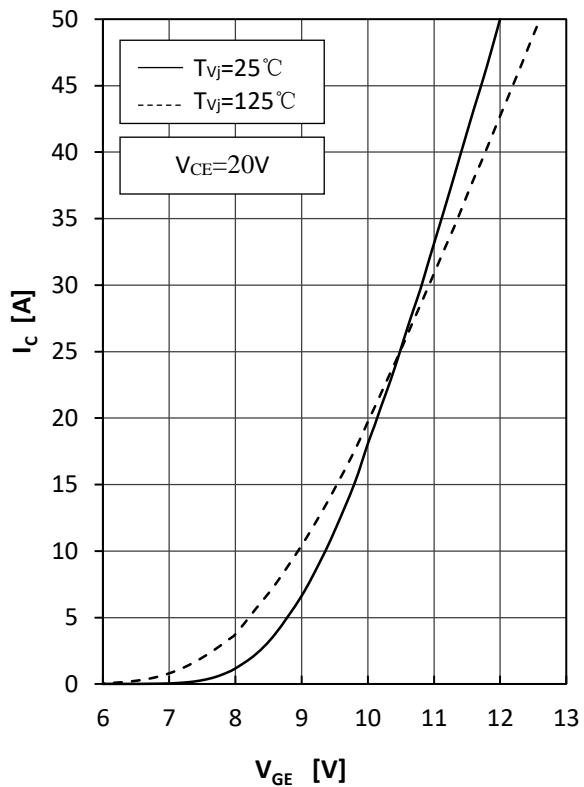

Fig2.IGBT Transfer Characteristics

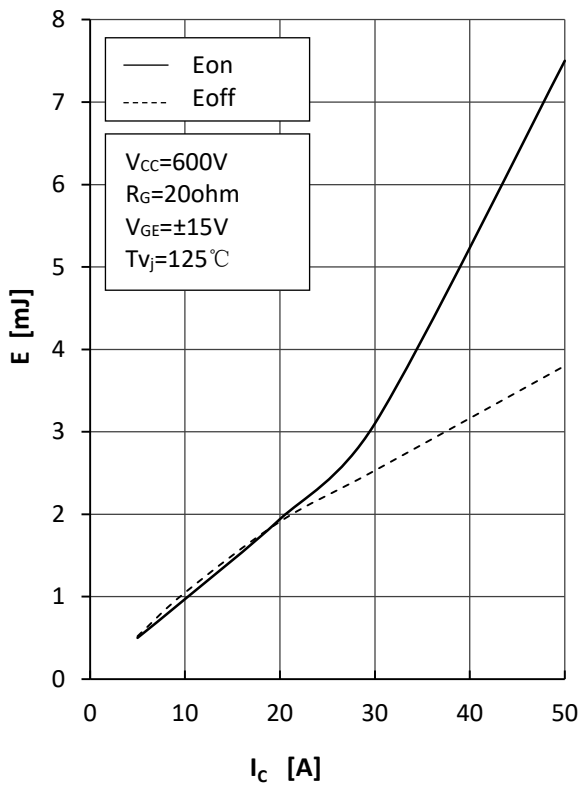

Fig3.IGBT Switching Loss vs.Ic

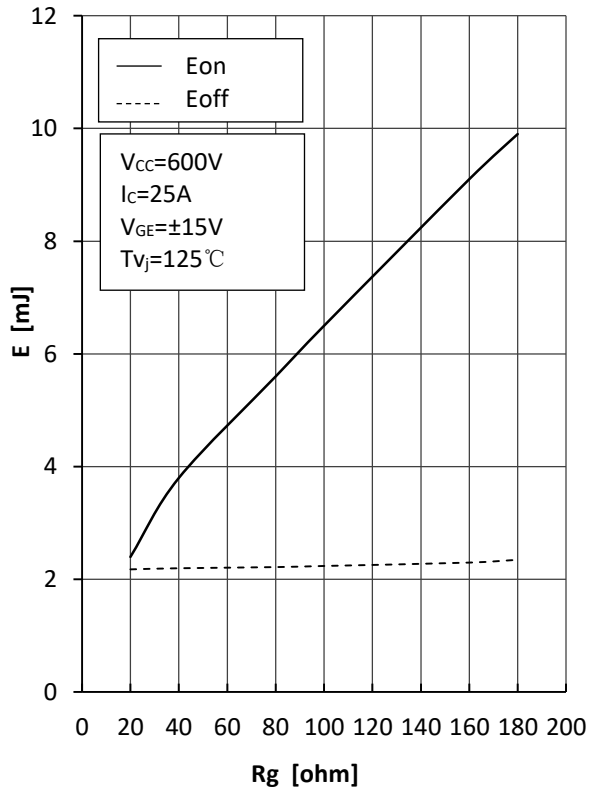
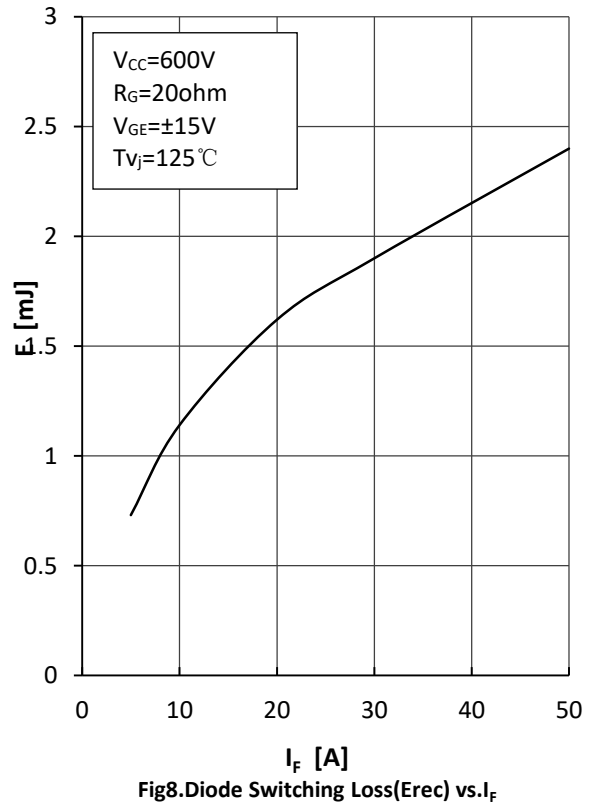
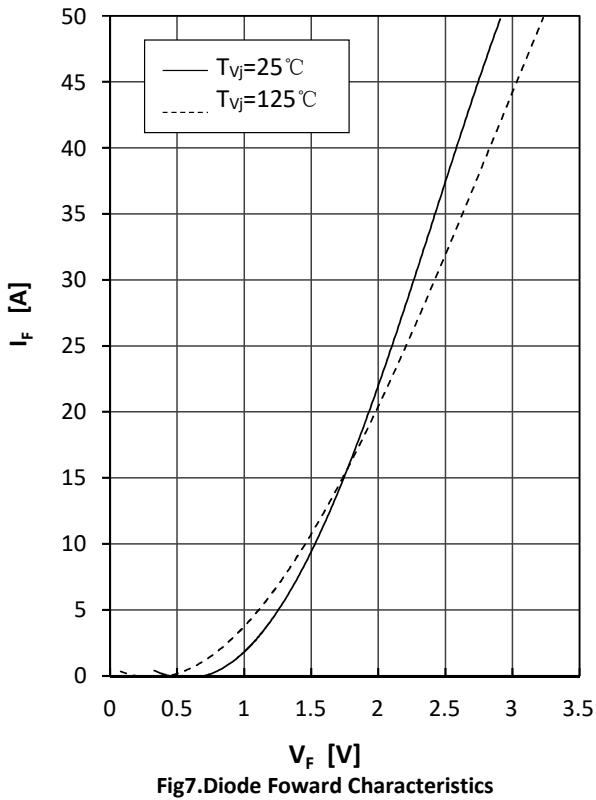
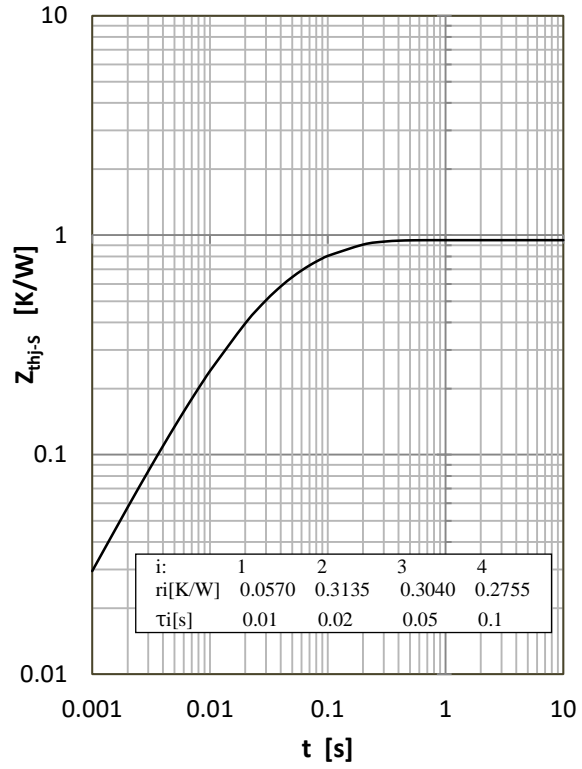
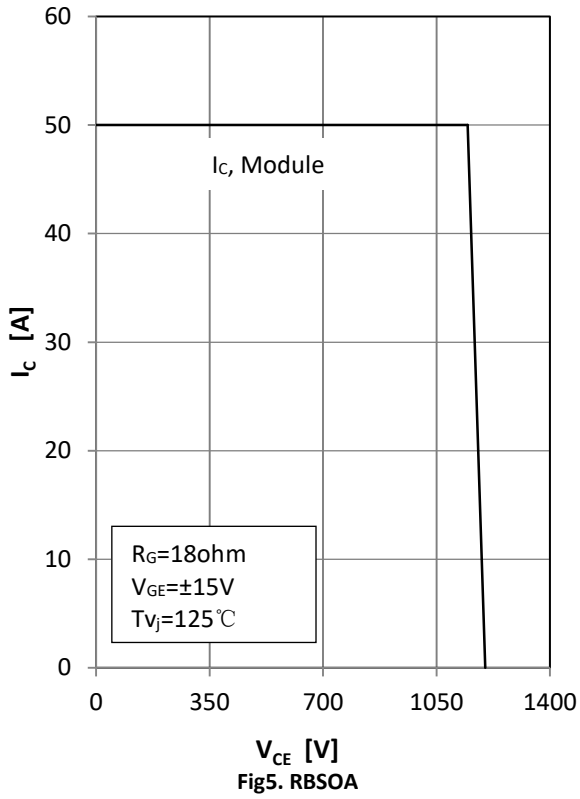

Fig4.IGBT Switching Loss vs.Rg

Curve Characteristics



Curve Characteristics

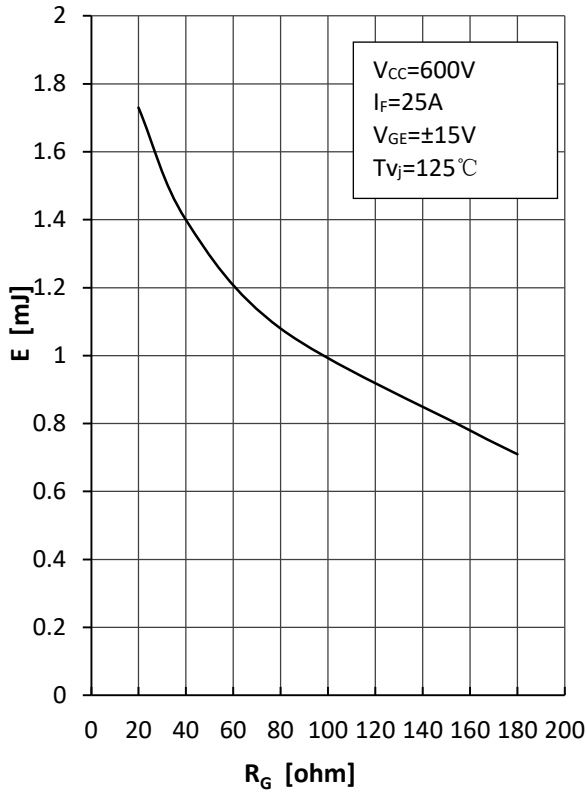

Fig9.Diode Switching Loss(Erec) vs.Rg

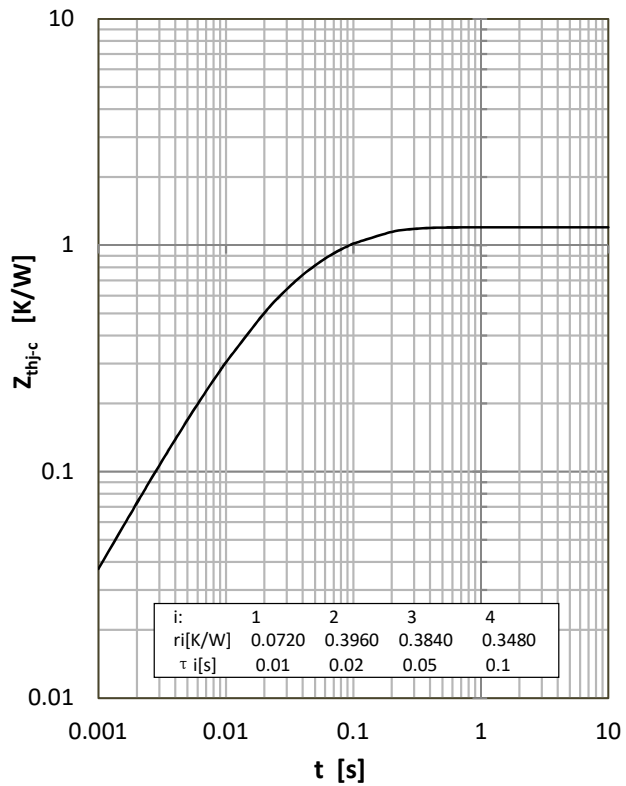

Fig10.Diode Transient Thermal Impedance

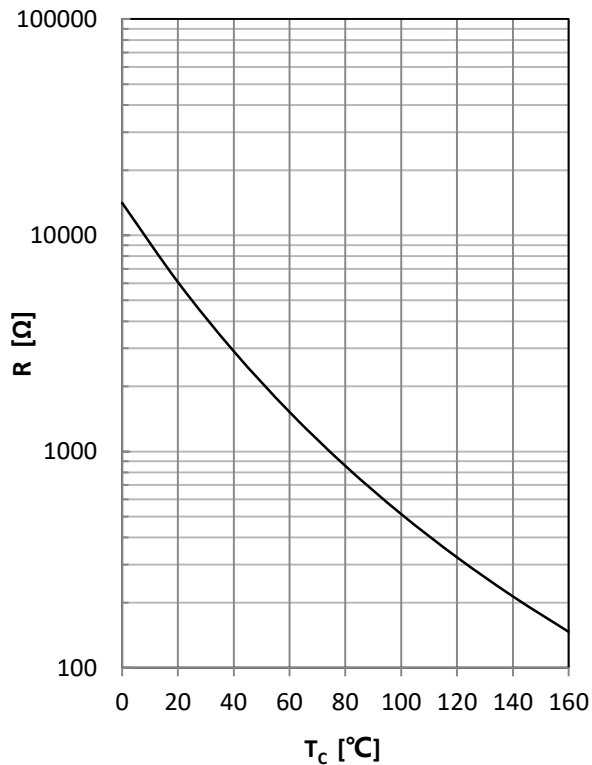
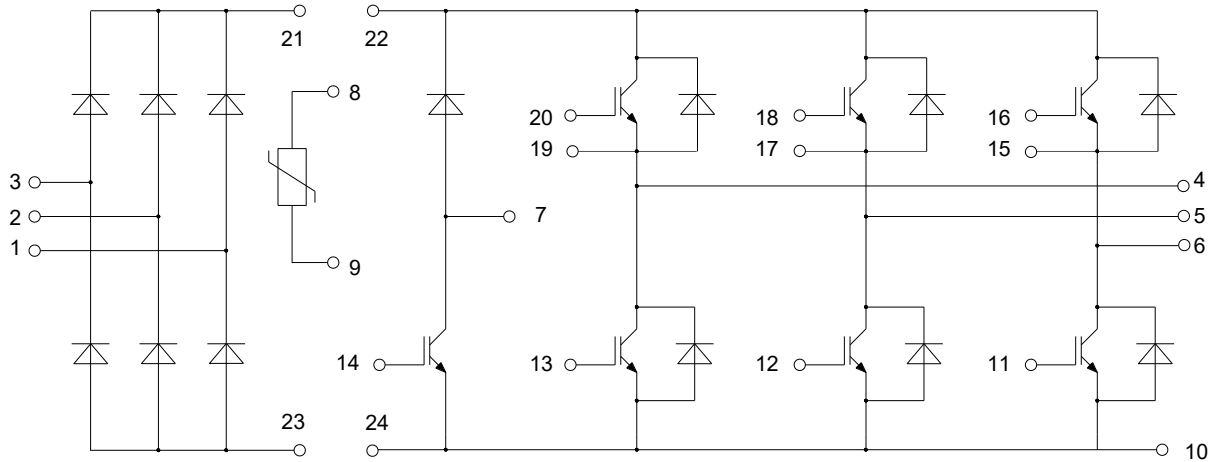

Fig 11. NTC Temperature Characteristic

Circuit Diagram



Package Dimensions

E1

Dimensions in mm

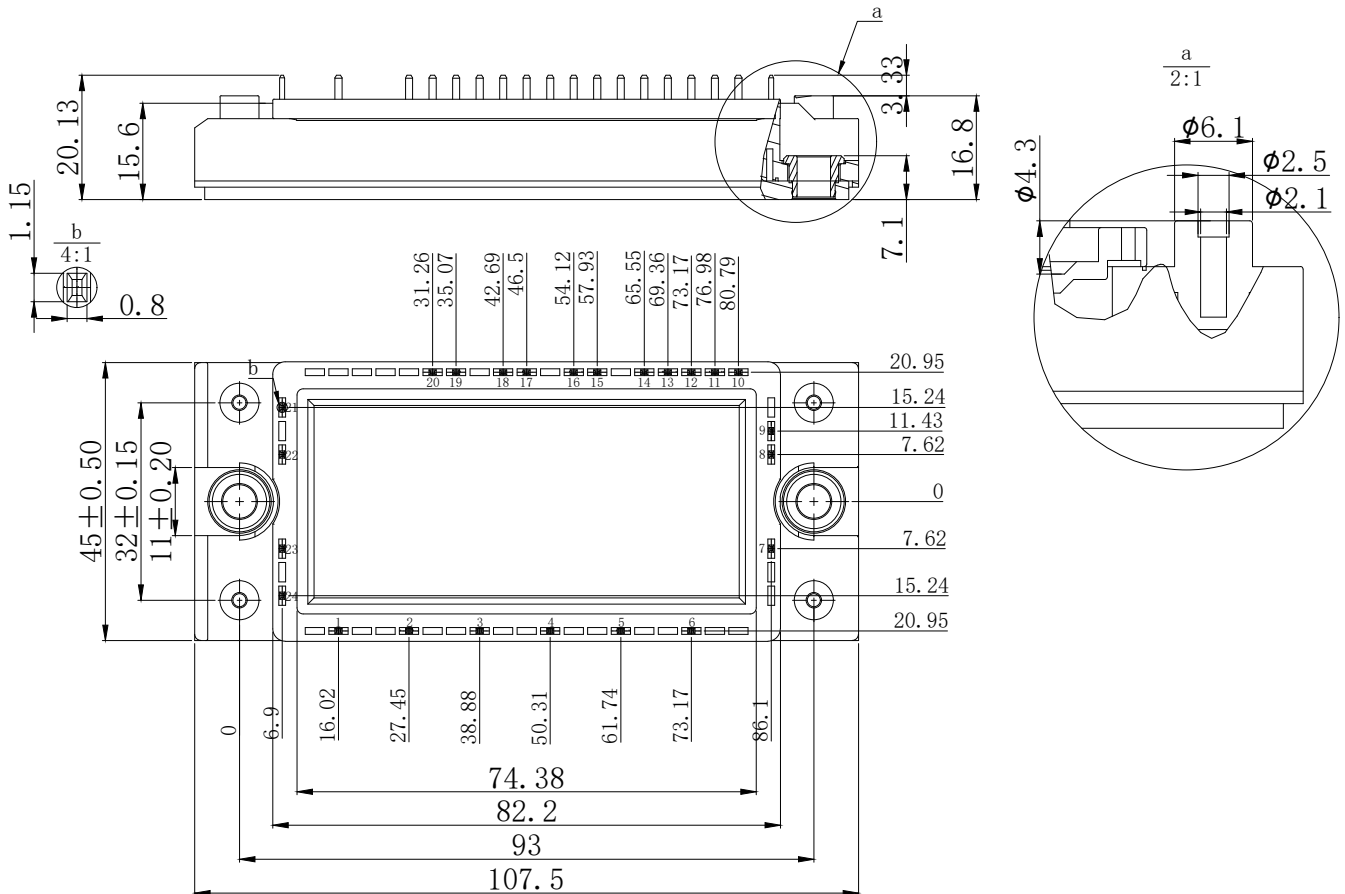

Ordering Information

Device	Packing
Part Number-BP	Bulk: 10pcs/Box ; 70pcs/Ctn

*****IMPORTANT NOTICE*****

Micro Commercial Components Corp. reserves the right to make changes without further notice to any product herein to make corrections, modifications , enhancements , improvements , or other changes . **Micro Commercial Components Corp** . does not assume any liability arising out of the application or use of any product described herein; neither does it convey any license under its patent rights ,nor the rights of others . The user of products in such applications shall assume all risks of such use and will agree to hold **Micro Commercial Components Corp** . and all the companies whose products are represented on our website, harmless against all damages. **Micro Commercial Components Corp.** products are sold subject to the general terms and conditions of commercial sale, as published at <https://www.mccsemi.com/Home/TermsAndConditions>.

*****LIFE SUPPORT*****

MCC's products are not authorized for use as critical components in life support devices or systems without the express written approval of Micro Commercial Components Corporation.

*****CUSTOMER AWARENESS*****

Counterfeiting of semiconductor parts is a growing problem in the industry. Micro Commercial Components (MCC) is taking strong measures to protect ourselves and our customers from the proliferation of counterfeit parts. MCC strongly encourages customers to purchase MCC parts either directly from MCC or from Authorized MCC Distributors who are listed by country on our web page cited below. Products customers buy either from MCC directly or from Authorized MCC Distributors are genuine parts, have full traceability, meet MCC's quality standards for handling and storage. **MCC will not provide any warranty coverage or other assistance for parts bought from Unauthorized Sources.** MCC is committed to combat this global problem and encourage our customers to do their part in stopping this practice by buying direct or from authorized distributors.