

## GT4-S

~20° spot beam

### SPECIFICATION:

Dimensions	Ø 35.0 mm
Height	9 mm
Fastening	glue, pin
ROHS compliant	yes ⓘ

### MATERIALS:

Component	Type	Material	Colour	Finish
GT4-S	Multi-lens	PMMA	clear	

### ORDERING INFORMATION:

Component	Qty in box	MOQ	MPQ	Box weight (kg)
C10921_GT4-S » Box size: 300 x 250 x 250 mm	864	144	144	4.8



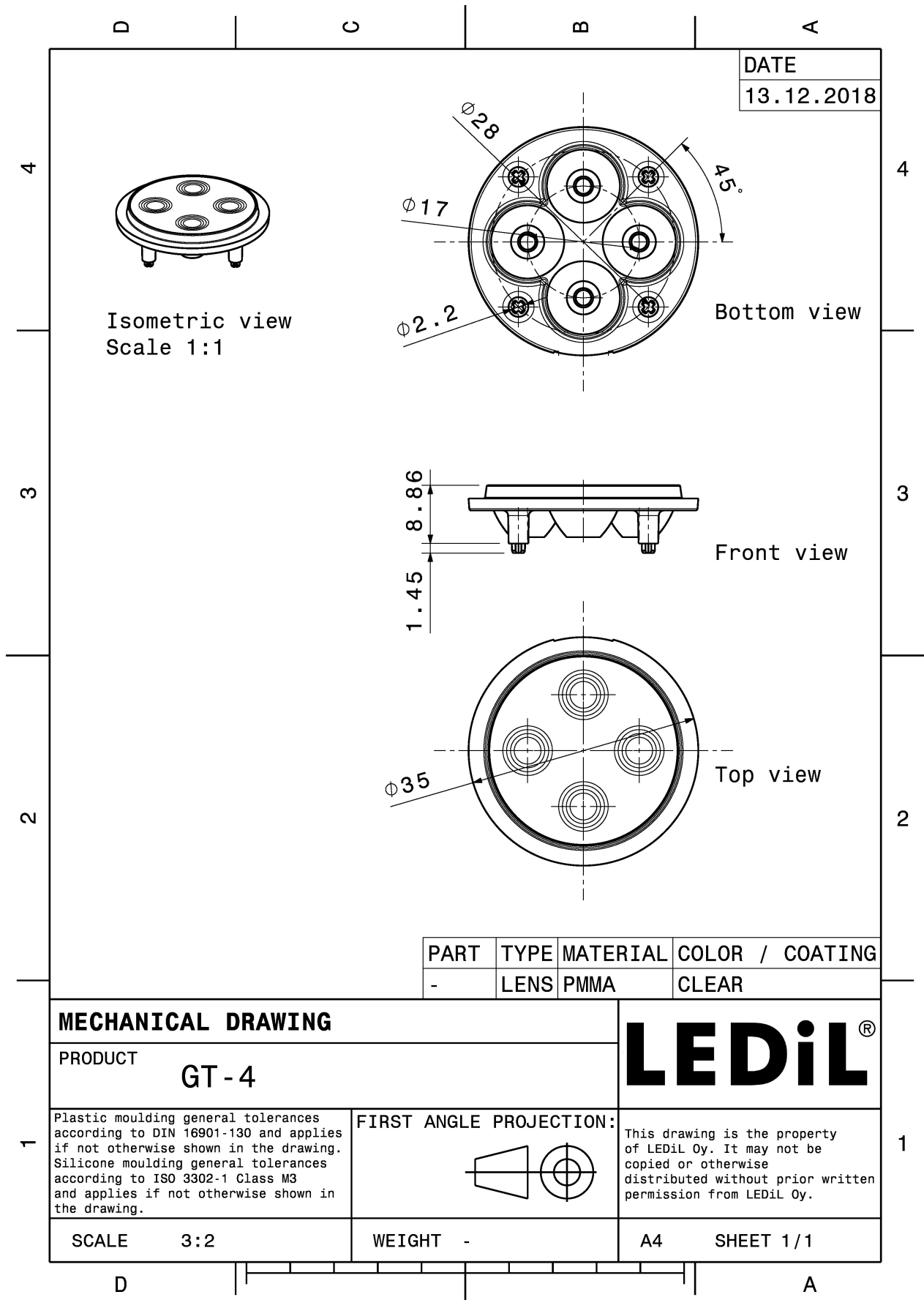

See also our general installation guide: [www.ledil.com/installation\\_guide](http://www.ledil.com/installation_guide)

### OPTICAL RESULTS (MEASURED):

#### CREE LED

LED XB-D  
 FWHM / FWTM 24.0°  
 Efficiency 87 %  
 Peak intensity 2.3 cd/lm  
 LEDs/each optic 1  
 Light colour White  
 Required components:



#### CREE LED

LED XP-E  
 FWHM / FWTM 18.0° / 42.0°  
 Efficiency 88 %  
 Peak intensity 4.9 cd/lm  
 LEDs/each optic 1  
 Light colour White  
 Required components:

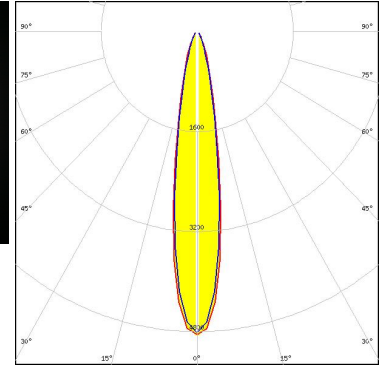
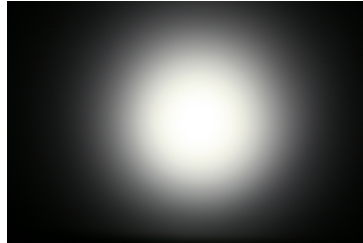

#### CREE LED

LED XP-G  
 FWHM / FWTM 23.0° / 50.0°  
 Efficiency 86 %  
 Peak intensity 3 cd/lm  
 LEDs/each optic 1  
 Light colour White  
 Required components:

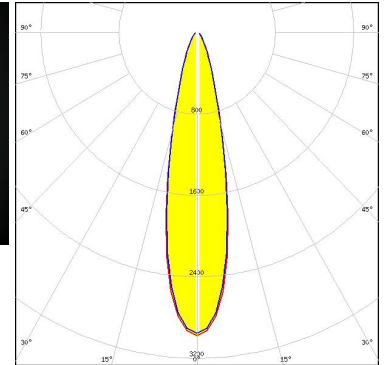

#### LUMILEDS

LED LUXEON A  
 FWHM / FWTM 22.0° / 50.0°  
 Efficiency %  
 LEDs/each optic 1  
 Light colour White  
 Required components:

### OPTICAL RESULTS (MEASURED):

#### LUMILEDS

LED LUXEON Rebel ES  
 FWHM / FWTM 28.0° / 61.0°  
 Efficiency 89 %  
 Peak intensity 2 cd/m  
 LEDs/each optic 1  
 Light colour White  
 Required components:

#### OSRAM Opto Semiconductors

LED OSLON SSL 150  
 FWHM / FWTM 20.0° / 44.0°  
 Efficiency 90 %  
 Peak intensity 3.6 cd/m  
 LEDs/each optic 1  
 Light colour White  
 Required components:

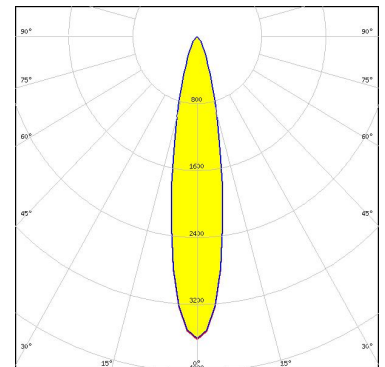

#### OSRAM Opto Semiconductors

LED OSLON SSL 80  
 FWHM / FWTM 24.0° / 55.0°  
 Efficiency 92 %  
 Peak intensity 2.5 cd/m  
 LEDs/each optic 1  
 Light colour White  
 Required components:

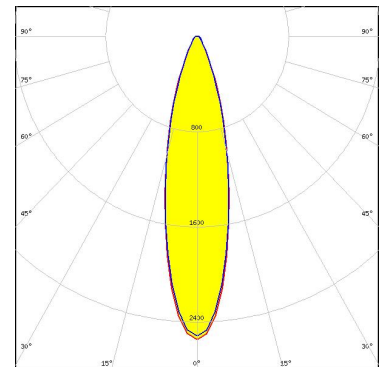

#### SHARP

LED Double Dome (GM2BB)  
 FWHM / FWTM 22.0°  
 Efficiency %  
 LEDs/each optic 1  
 Light colour White  
 Required components:

### OPTICAL RESULTS (SIMULATED):

#### OSRAM Opto Semiconductors

LED Synios P2720 1/4 mm  
FWHM / FWTM 12.0° / 27.0°  
Efficiency 94 %  
Peak intensity 11.9 cd/lm  
LEDs/each optic 1  
Light colour White  
Required components:

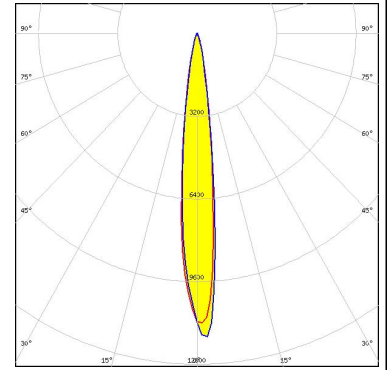

#### SEOL SEMICONDUCTOR

LED Z5  
FWHM / FWTM 18.0°  
Efficiency %  
LEDs/each optic 1  
Light colour White  
Required components:

### GENERAL INFORMATION:

NOTE: The typical beam angle will be changed by different color, chip size and chip position tolerance. The typical total beam angle is the full angle measured where the luminous intensity is half of the peak value.

### MATERIALS:

As part of our continuous research and improvement processes, and to ensure the best possible quality and availability of our products, LEDiL reserves the right to change material grades without notice.

### PRODUCT DATA USER AGREEMENT AND DISCLAIMER:

The measured data in the provided downloadable LEDiL Product Datasheets and Mechanical 2D-Drawings is rounded and provided as reference for planning. LEDiL Oy's optical specifications have been verified by conducting performance testing of the products in accordance with the company's quality system. The reported data are averaged results of multiple measurements with typical variation. LEDiL Oy reserves the right to without prior notification make changes and improvements to its products.

LEDiL Oy assumes neither warranty, nor guarantee nor any other liability of any kind for the contents and correctness of the provided data. The provided data has been generated with highest diligence but the provided data may in reality not represent the complete possible variation range of all intrinsic parameters. Therefore, in certain cases a deviation from the provided data could occur.

LEDiL Oy reserves the right to undertake technical changes of its products without further notification which could lead to changes in the provided data. LEDiL Oy assumes no liability of any kind for the possible deviation from any provided data or any other damage resulting from the usage of the provided data.

The user agrees to this disclaimer and user agreement with the download or usage of the provided files.

#### LEDiL Oy

Joensuunkatu 13  
FI-24240 SALO  
Finland

#### LEDiL Inc.

228 West Page Street  
Suite D  
Sycamore IL 60178  
USA

#### Ledil Optics Technology (Shenzhen) Co., Ltd.

# 405 , Block B  
Casic Motor Building  
Shenzhen 518057  
P.R.CHINA

#### Local sales and technical support

[www.ledil.com/  
where\\_to\\_buy](http://www.ledil.com/where_to_buy)

#### Shipping locations

Salo, Finland  
Hong Kong, China

#### Distribution Partners

[www.ledil.com/  
where\\_to\\_buy](http://www.ledil.com/where_to_buy)