

PRELIMINARY SPEC



ATTENTION
OBSERVE PRECAUTIONS
FOR HANDLING
ELECTROSTATIC
DISCHARGE
SENSITIVE
DEVICES

Part Number: AAAF5060QBFSURZGC

Blue
Hyper Red
Green

Features

- Chips can be controlled separately.
- Suitable for all SMT assembly and solder process.
- Available on tape and reel.
- Package: 500pcs / reel.
- Moisture sensitivity level : level 4.
- RoHS compliant.

Description

The Blue source color devices are made with InGaN Light Emitting Diode.

The Hyper Red source color devices are made with AlGaInP on GaAs substrate Light Emitting Diode.

The Green source color devices are made with InGaN on Sapphire Light Emitting Diode.

Static electricity and surge damage the LEDs.

It is recommended to use a wrist band or anti-electrostatic glove when handling the LEDs.

All devices, equipment and machinery must be electrically grounded.

Package Dimensions

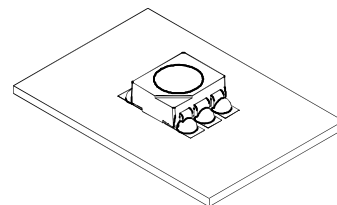
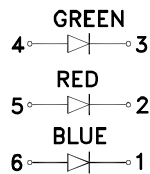
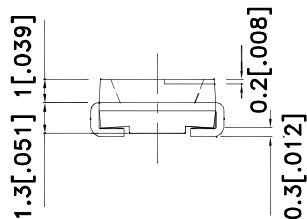
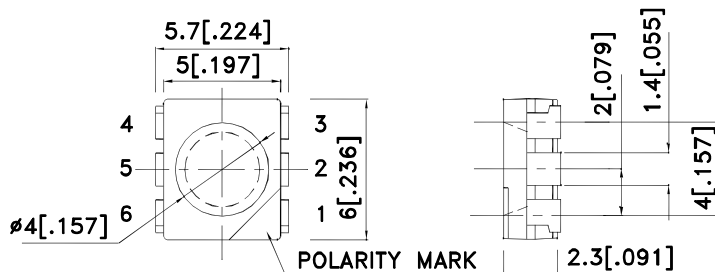

Notes:

1. All dimensions are in millimeters (inches).
2. Tolerance is $\pm 0.25(0.01)$ " unless otherwise noted.
3. Specifications are subject to change without notice.
4. The device has a single mounting surface. The device must be mounted according to the specifications.



Selection Guide

Part No.	Dice	Lens Type	Iv (mcd) [2] @ 30mA *50mA		Viewing Angle [1]
			Min.	Typ.	2θ1/2
AAAF5060QBFSURZGC	Blue (InGaN)	WATER CLEAR	180	350	100°
	Hyper Red (AlGaInP)		*380	*500	
	Green (InGaN)		280	650	

Notes:

1. θ1/2 is the angle from optical centerline where the luminous intensity is 1/2 of the optical peak value.
2. *Luminous intensity with asterisk is measured at 50mA; Luminous intensity/ luminous Flux: +/-15%.

Electrical / Optical Characteristics at TA=25°C

Symbol	Parameter	Device	Typ.	Max.	Units	Test Conditions
λ _{peak}	Peak Wavelength	Blue Hyper Red Green	461 650 515		nm	I _F =20mA
λ _D [1]	Dominant Wavelength	Blue Hyper Red Green	465 630 525		nm	I _F =20mA
Δλ _{1/2}	Spectral Line Half-width	Blue Hyper Red Green	25 27 30		nm	I _F =20mA
C	Capacitance	Blue Hyper Red Green	100 45 45		pF	V _F =0V;f=1MHz
V _F [2]	Forward Voltage	Blue Hyper Red Green	3.3 1.9 3.3	4 2.5 4.1	V	I _F =20mA
I _R	Reverse Current	Blue Hyper Red Green		10 10 10	uA	V _R =5V

Notes:

1. Wavelength: +/-1nm.
2. Forward Voltage: +/-0.1V.

Absolute Maximum Ratings at TA=25°C

Parameter	Blue	Hyper Red	Green	Units
Power dissipation[2]	350			mW
DC Forward Current	30	50	30	mA
Peak Forward Current [1]	150	185	150	mA
Reverse Voltage	5			V
Operating Temperature	-40°C To +85°C			
Storage Temperature	-40°C To +85°C			

Notes:

1. 1/10 Duty Cycle, 0.1ms Pulse Width.
2. Within 350mW at all chips are lightened.

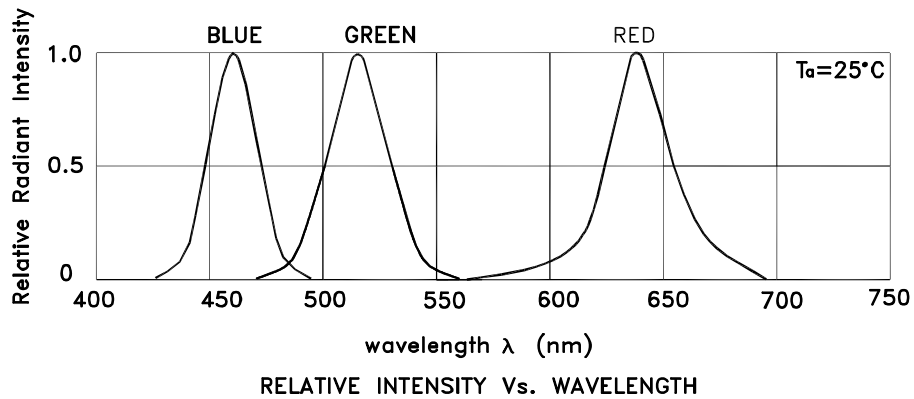

AAAF5060QBFSURZGC Blue

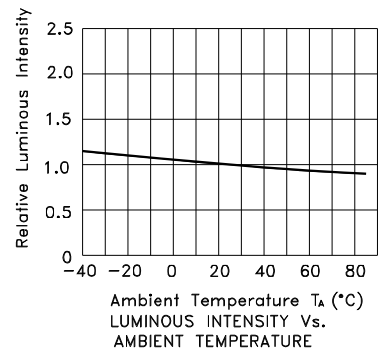
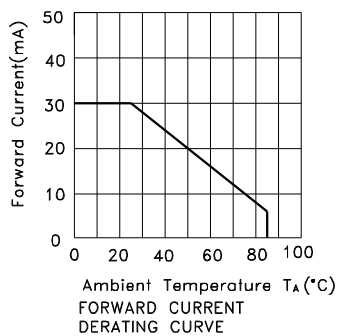
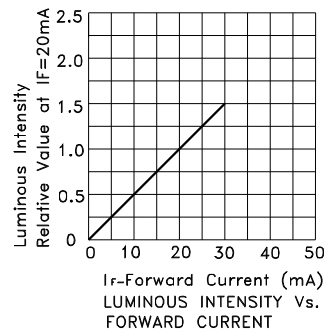
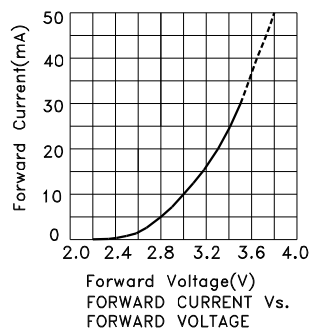

Kingbright

Hyper Red

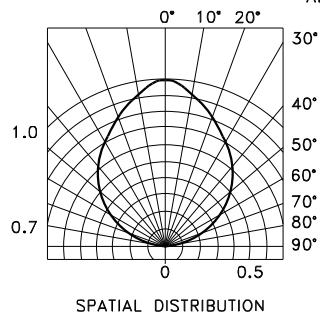
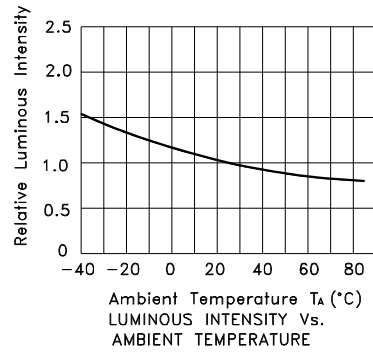
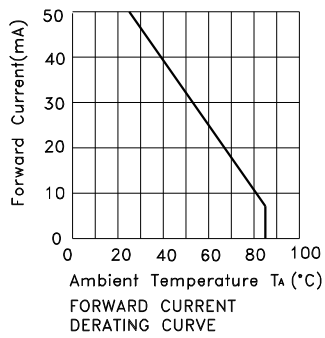
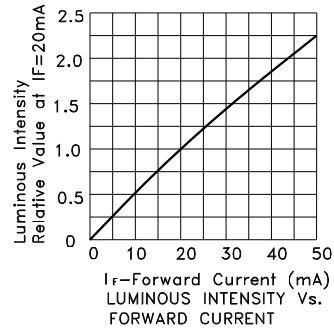
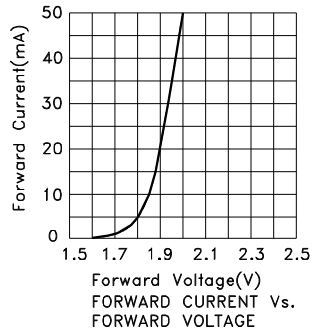

Kingbright

Green

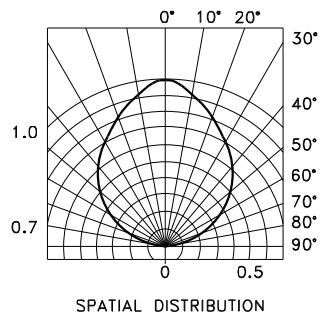
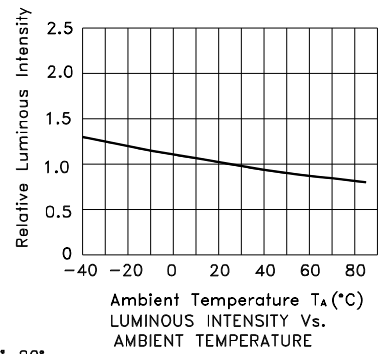
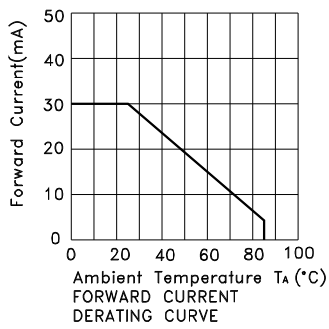
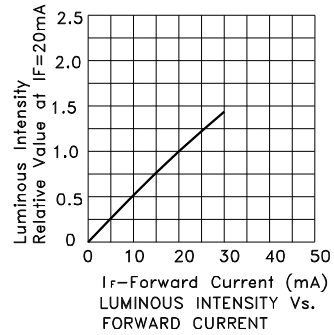
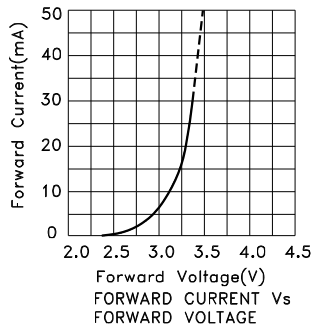

AAAF5060QBFSURZGC

Reflow soldering is recommended and the soldering profile is shown below.
Other soldering methods are not recommended as they might cause damage to the product.

Reflow Soldering Profile For Lead-free SMT Process.

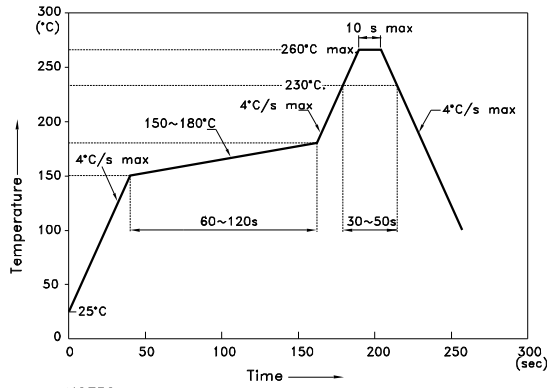

NOTES:

1. We recommend the reflow temperature 245°C(+/-5°C). The maximum soldering temperature should be limited to 260°C.
2. Don't cause stress to the epoxy resin while it is exposed to high temperature.
3. Number of reflow process shall be 2 times or less.

Recommended Soldering Pattern (Units : mm; Tolerance: ± 0.1)

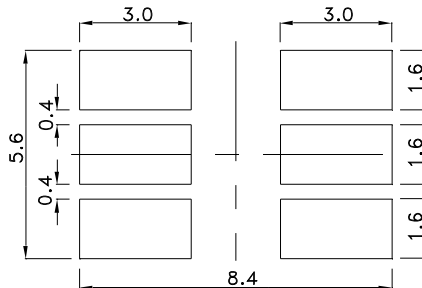

Tape Dimensions (Units : mm)

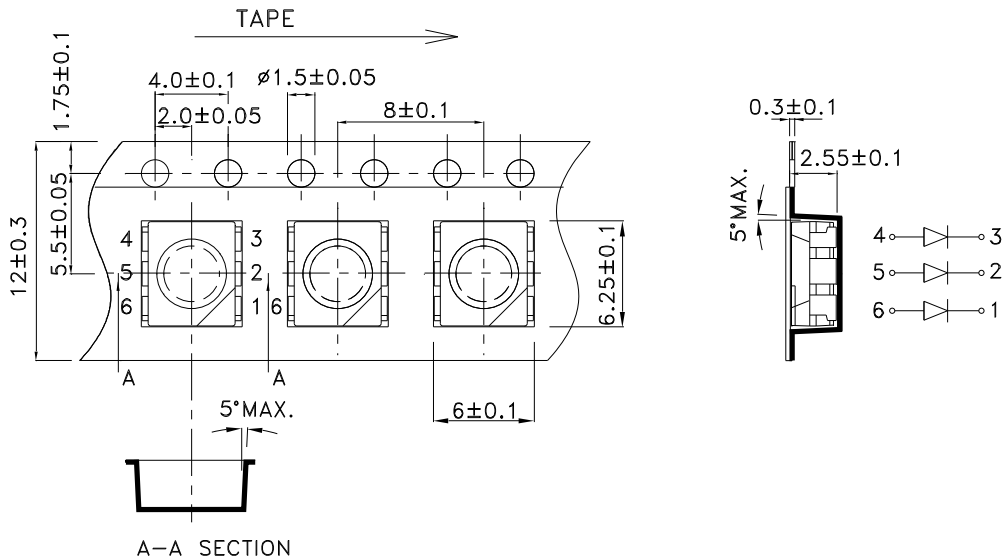

Kingbright

PACKING & LABEL SPECIFICATIONS

AAAF5060QBFSURZGC

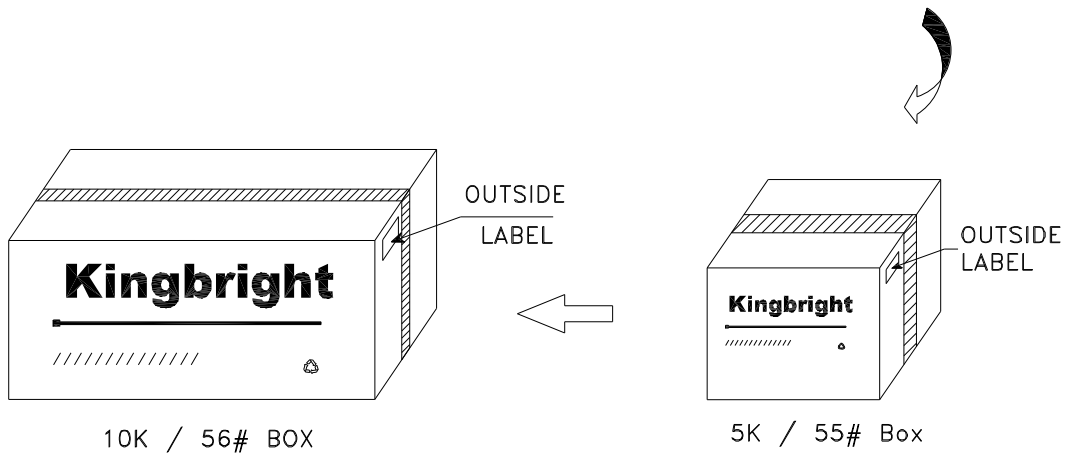
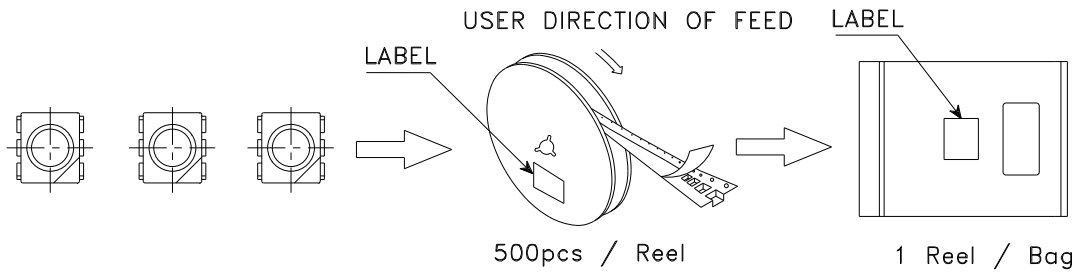

<h2>Kingbright</h2>	
P/NO: AAAF5060xxx	
QTY: 500 pcs	Q.C. Q C xx xx xxxx PASSED
S/N: XXXX	
CODE: XXX	
LOT NO:	
 <small>XXXXXXXXXXXXXXXXXXXXXXXXXXXX</small>	
RoHS Compliant	