

TRS3-70MCR01

Aliases (USED70MCR01000)

KEMET, TRS, Thermal Reed Switch, Axial, 2.5C Temperature Accuracy, High Reliability, High-Speed Response, Long Operational Life, Excellent Environmental Durability, High Temperature Accuracy, 70°C, Make

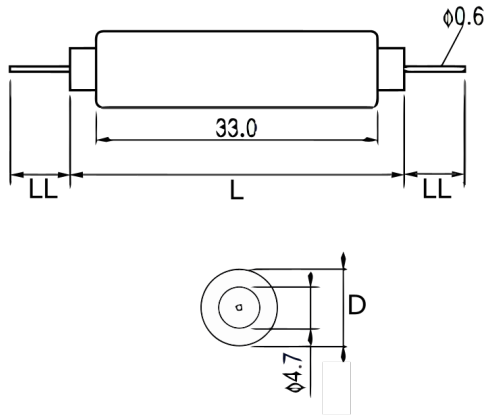

Click [here](#) for the 3D model.

Dimensions

D	7mm NOM
L	40mm NOM
LL	8.5mm NOM

Packaging Specifications

Packaging	Tray, Box
Packaging Quantity	600
Component Weight	3.4 g

General Information

Series	TRS
Type	Thermal Reed Switch
Style	Axial
Description	Thermal Reed Switch
Features	High Reliability, High-Speed Response, Long Operational Life, Excellent Environmental Durability, High Temperature Accuracy
Lead	Wire Leads
RoHS	Yes
REACH	Yes

Specifications

Switching Temperature	70C +/-2.5C
Temperature Range	-20/+130°C
Contact Type	Make
Voltage DC	200 VDC MAX (Opening/Closing), 1500 VAC/1 minute or 1800 VAC/1 second
Voltage AC	140 VAC MAX (Opening/Closing)
Current	0.5 Amps AC/DC MAX (Opening/Closing), 1 mAmps MIN (5VDC, Opening/Closing)
Resistance	150 mOhms MAX (Contact Resistance)
Max Opening/Closing Power	35 W (AC)
Max Opening/Closing Voltage	140 V (AC); 200 V (DC)
Differential Temperature	10C Maximum