

### Features and Benefits

- Wide operating voltage range: from 2.7V to 24V
- Chopper-stabilized amplifier stage
- Built-in negative temperature coefficient
- Reverse Supply Voltage Protection
- High ESD rating / Excellent EMC performance

### Applications

- Consumer and Industrial
- Solid-state switch
- E-Bike
- Motorcycles
- 3-phase BLDC motor commutation

### Ordering information

Part No.	Temperature Code	Package Code	Comment
MLX92215LUA-AAA-000-BU	L (-40°C to 150°C)	UA (TO92-3L)	B <sub>OP</sub> /B <sub>RP</sub> = ± 3mT, TC = -1100 ppm/°C
MLX92215LSE-AAA-000-RE	L (-40°C to 150°C)	SE (TSOT-23)	B <sub>OP</sub> /B <sub>RP</sub> = ± 3mT, TC = -1100 ppm/°C
MLX92215LSE-ACA-000-RE	L (-40°C to 150°C)	SE (TSOT-23)	B <sub>OP</sub> /B <sub>RP</sub> = ± 3mT, TC = -2000 ppm/°C Inverted output
MLX92215LUA-AEA-000-RE	L (-40°C to 150°C)	UA (TO92-3L)	B <sub>OP</sub> /B <sub>RP</sub> = ± 3mT, TC = -1100 ppm/°C
MLX92215LSE-AEA-000-RE	L (-40°C to 150°C)	SE (TSOT-23)	B <sub>OP</sub> /B <sub>RP</sub> = ± 3mT, TC = -1100 ppm/°C
MLX92215LSE-AFA-000-RE	L (-40°C to 150°C)	SE (TSOT-23)	North Active MLX92215LSE-AEA-000
MLX92215KLD-AAA-000-RE	K (-40°C to 125°C)	LD (UTQFN)	B <sub>OP</sub> /B <sub>RP</sub> = ± 3mT, TC = -1100 ppm/°C

Option code	HBM
Lxx-AAA, LSE-ACA	4kV
Lxx-AEA, LSE-AFA, KLD-AAA	8kV

### 1. Functional Diagram

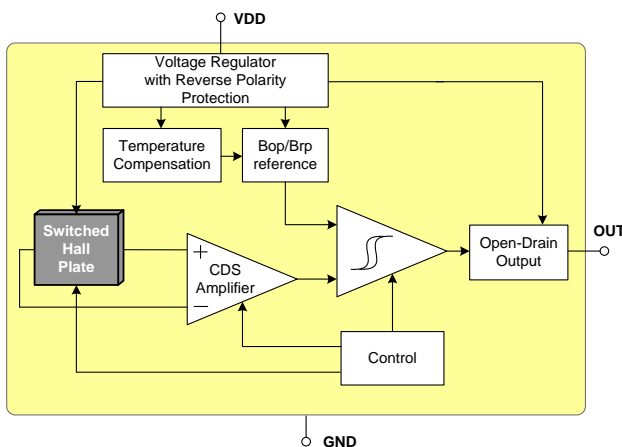

### 2. General Description

The Melexis MLX92215 is the second generation Hall-effect latch designed in mixed signal CMOS technology. The device integrates a voltage regulator, Hall sensor with advanced offset cancellation system and an open-drain output driver, all in a single package. Based on the existing platform, the magnetic core is using an improved offset cancellation system allowing faster and more accurate processing while being temperature insensitive and stress independent. In addition is implemented a negative temperature coefficient to compensate the natural behaviour of magnets becoming weaker with rise in temperature.

The included voltage regulator operates from 2.7V to 24V, hence covering a wide range of applications. With the built-in reverse voltage protection, a serial resistor or diode on the supply line is not required so that even remote sensors can be specified for low voltage operation down to 2.7V while being reverse voltage tolerant.

With latching magnetic characteristics, the output is turned low or high respectively with a sufficiently strong South or North pole facing the package top side. When removing the magnetic field, the device keeps its previous state.

## Contents

Features and Benefits.....	1
Applications.....	1
Ordering information .....	1
1. Functional Diagram .....	1
2. General Description.....	1
3. Absolute Maximum Ratings.....	4
4. General Electrical Specifications.....	5
5. Magnetic Specifications.....	6
5.1. MLX92215LSE-AAA-000 / MLX92215LUA-AAA-000.....	6
5.2. MLX92215LSE-ACA-000.....	6
5.3. MLX92215LUA-AEA-000 / MLX92215LSE-AEA-000 .....	6
5.4. MLX92215LSE-AFA-000 .....	6
5.5. MLX92215KLD-AAA-000 .....	7
6. Output Behavior versus Magnetic Pole .....	7
6.1. South Pole Active .....	7
6.2. North Pole Active .....	7
7. Performance Graphs .....	8
7.1. Magnetic parameters vs. $T_A$ .....	8
7.2. Magnetic parameters vs. $V_{DD}$ .....	8
7.3. $V_{DSon}$ vs. $T_A$ .....	8
7.4. $V_{DSon}$ vs. $V_{DD}$ .....	8
7.5. $I_{DD}$ vs. $T_A$ .....	8
7.6. $I_{DD}$ vs. $V_{DD}$ .....	8
7.7. $I_{OFF}$ vs. $T_A$ .....	9
7.8. $I_{OFF}$ vs. $V_{OUT}$ .....	9
7.9. SE Power Derating vs. $T_A$ .....	9
7.10. UA Voltage Derating vs. $T_A$ .....	9
7.11. LD power Derating vs. $T_A$ .....	9
8. Application Information.....	10
8.1. Typical Three-Wire Application Circuit.....	10
9. Standard information regarding manufacturability of Melexis products with different soldering processes.....	11
10. ESD Precautions .....	11

- 11. Packages.....12**
  - 11.1. SE Package (TSOT-23) package information.....12
  - 11.2. UA (TO92 - 3L) package information .....13
  - 11.3. LD (UTQFN) package information .....14
- 12. Contact.....15**
- 13. Disclaimer.....15**

### 3. Absolute Maximum Ratings

Parameter	Symbol	Value	Units
Supply Voltage <sup>(1, 2)</sup>	V <sub>DD</sub>	+27	V
Supply Voltage (Load dump) <sup>(1, 3)</sup>	V <sub>DD</sub>	+32	V
Supply Current <sup>(1, 2, 4)</sup>	I <sub>DD</sub>	+20	mA
Supply Current <sup>(1, 3, 4)</sup>	I <sub>DD</sub>	+50	mA
Reverse Supply Voltage <sup>(1, 2)</sup>	V <sub>DDREV</sub>	-24	V
Reverse Supply Voltage (Load dump) <sup>(1, 3)</sup>	V <sub>DDREV</sub>	-30	V
Reverse Supply Current <sup>(1, 2, 5)</sup>	I <sub>DDREV</sub>	-20	mA
Reverse Supply Current <sup>(1, 3, 5)</sup>	I <sub>DDREV</sub>	-50	mA
Output Voltage <sup>(1, 2)</sup>	V <sub>OUT</sub>	+27	V
Output Current <sup>(1, 2, 5)</sup>	I <sub>OUT</sub>	+20	mA
Output Current <sup>(1, 3, 6)</sup>	I <sub>OUT</sub>	+75	mA
Reverse Output Voltage <sup>(1)</sup>	V <sub>OUTREV</sub>	-0.5	V
Reverse Output Current <sup>(1, 2)</sup>	I <sub>OUTREV</sub>	-50	mA
Operating Temperature Range	T <sub>A</sub>	-40 to +150	°C
Storage Temperature Range	T <sub>S</sub>	-55 to +165	°C
Maximum Junction Temperature <sup>(7)</sup>	T <sub>J</sub>	+165	°C
ESD Sensitivity – HBM <sup>(8) (9)</sup>	-	4000	V
ESD Sensitivity – HBM <sup>(8) (10)</sup>	-	8000	V
ESD Sensitivity – MM <sup>(11)</sup>	-	500	V
ESD Sensitivity – CDM <sup>(12)</sup>	-	1000	V
Magnetic Flux Density	B	Unlimited	mT

Exceeding the absolute maximum ratings may cause permanent damage. Exposure to absolute-maximum-rated conditions for extended periods may affect device reliability.

<sup>1</sup> The maximum junction temperature should not be exceeded

<sup>2</sup> For maximum 1 hour

<sup>3</sup> For maximum 0.5 s

<sup>4</sup> Including current through protection device

<sup>5</sup> Through protection device

<sup>6</sup> For V<sub>OUT</sub> ≤ 27V

<sup>7</sup> For 1000 hours

<sup>8</sup> Human Model according AEC-Q100-002 standard

<sup>9</sup> Valid for version Lxx-AAA and LSE-ACA

<sup>10</sup> Valid for version Lxx-AEA, LSE-AFA, KLD-AAA

<sup>11</sup> Machine Model according AEC-Q100-003 standard

<sup>12</sup> Charged Device Model according AEC-Q100-011 standard

## 4. General Electrical Specifications

DC Operating Parameters  $T_A = -40^{\circ}\text{C}$  to  $150^{\circ}\text{C}$ ,  $V_{DD} = 2.7\text{V}$  to  $24\text{V}$  (unless otherwise specified)

Parameter	Symbol	Test Conditions	Min	Typ <sup>(1)</sup>	Max	Units
Supply Voltage	$V_{DD}$	Operating	2.7	-	24	V
Supply Current	$I_{DD}$		1.5	3.0	4.5	mA
Reverse Supply Current	$I_{DDREV}$	$V_{DD} = -18\text{V}$			1	mA
Output Leakage Current	$I_{OFF}$	$V_{OUT} = 12\text{V}$ , $V_{DD} = 12\text{V}$ , $B < Brp$		0.1	10	$\mu\text{A}$
Output Saturation Voltage	$V_{DSON}$	$B > B_{OP}$ , $V_{DD} = 3.8$ to $18\text{V}$ , $I_{OUT} = 20\text{mA}$		0.2	0.5	V
Output Rise Time <sup>(2)</sup> ( $R_{PU}$ dependent)	$t_R$	$V_{DD} = 12\text{V}$ , $V_{PU}^{(3)} = 5\text{V}$ , $R_{PU} = 1\text{k}\Omega$ $C_{LOAD} = 50\text{pF}$ to GND	0.1	0.3	1	$\mu\text{s}$
Output Fall Time <sup>(2)</sup> (On-chip controlled)	$t_F$	$V_{DD} = 12\text{V}$ , $V_{PU} = 5\text{V}$ , $R_{PU} = 1\text{k}\Omega$ $C_{LOAD} = 50\text{pF}$ to GND	0.1	0.3	1	$\mu\text{s}$
Chopping Frequency	$f_{CHOP}$			340		kHz
Output Refresh Period <sup>(2)</sup>	$t_{PER}$			6		$\mu\text{s}$
Delay time <sup>(2,4)</sup>	$t_D$	Average over 1000 successive switching events @10kHz, square wave with $B \geq 30\text{mT}$ , $t_{RISE} = t_{FALL} \leq 20\mu\text{s}$		6		$\mu\text{s}$
Output Jitter (p-p) <sup>(2,5)</sup>	$t_{JITTER}$	Over 1000 successive switching events @1kHz, square wave with $B \geq 30\text{mT}$ , $t_{RISE} = t_{FALL} \leq 100\mu\text{s}$		$\pm 3$		$\mu\text{s}$
Maximum Switching Frequency <sup>(2,6)</sup>	$f_{SW}$	$B \geq 30\text{mT}$ and square wave magnetic field	30	50		kHz
Power-On Time <sup>(7,8)</sup>	$t_{ON}$	$V_{DD} = 5\text{V}$ , $dV_{DD}/dt > 2\text{V}/\mu\text{s}$		16	35	$\mu\text{s}$
SE Package Thermal Resistance	$R_{TH}$	Single layer (1S) Jedec board		300		$^{\circ}\text{C}/\text{W}$
UA Package Thermal Resistance	$R_{TH}$	Single layer (1S) Jedec board		200		$^{\circ}\text{C}/\text{W}$
LD Package Thermal Resistance	$R_{TH}$	Single layer (1S) Jedec board		250		$^{\circ}\text{C}/\text{W}$

<sup>1</sup> Typical values are defined at  $T_A = +25^{\circ}\text{C}$  and  $V_{DD} = 12\text{V}$

<sup>2</sup> Guaranteed by design and verified by characterization, not production tested

<sup>3</sup>  $R_{PU}$  and  $V_{PU}$  are respectively the external pull-up resistor and pull-up power supply

<sup>4</sup> The Delay Time is the time from magnetic threshold reached to the start of the output switching

<sup>5</sup> Output jitter is the unpredictable deviation of the Delay time

<sup>6</sup> Maximum switching frequency corresponds to the maximum frequency of the applied magnetic field which is detected without loss of pulses

<sup>7</sup> The Power-On Time represents the time from reaching  $V_{DD} = V_{POR}$  to the first refresh of the output (first valid output state)

<sup>8</sup> Power-On Slew Rate (is not critical for the proper device start-up)

## 5. Magnetic Specifications

### 5.1. MLX92215LSE-AAA-000 / MLX92215LUA-AAA-000

DC Operating Parameters  $V_{DD} = 3.8$  to  $24V$ ,  $T_A = -40^{\circ}C$  to  $150^{\circ}C$

Test Condition	Operating Point $B_{OP}$ (mT)			Release Point $B_{RP}$ (mT)			TC (ppm/ $^{\circ}C$ )	Active Pole
	Min	Typ <sup>(1)</sup>	Max	Min	Typ <sup>(1)</sup>	Max		
$T_J = -40^{\circ}C$	1	3.2	5	-5	-3.2	-1	-1100	South Pole
$T_J = 25^{\circ}C$	1	3	5	-5	-3.0	-1		
$T_J = 150^{\circ}C$	0.5	2.6	5	-5	-2.6	-0.5		

### 5.2. MLX92215LSE-ACA-000

DC Operating Parameters  $V_{DD} = 3.8$  to  $24V$ ,  $T_A = -40^{\circ}C$  to  $150^{\circ}C$

Test Condition	Operating Point $B_{OP}$ (mT)			Release Point $B_{RP}$ (mT)			TC (ppm/ $^{\circ}C$ )	Active Pole
	Min	Typ <sup>(1)</sup>	Max	Min	Typ <sup>(1)</sup>	Max		
$T_J = -40^{\circ}C$	1.2	3.2	5.5	-5.5	-3.2	-1.2	-2000	North Pole
$T_J = 25^{\circ}C$	1.0	2.8	4.7	-4.7	-2.8	-1.0		
$T_J = 150^{\circ}C$	0.5	2.1	4.2	-4.2	-2.1	-0.5		

### 5.3. MLX92215LUA-AEA-000 / MLX92215LSE-AEA-000

DC Operating Parameters  $V_{DD} = 3.8$  to  $24V$ ,  $T_A = -40^{\circ}C$  to  $150^{\circ}C$

Test Condition	Operating Point $B_{OP}$ (mT)			Release Point $B_{RP}$ (mT)			TC (ppm/ $^{\circ}C$ )	Active Pole
	Min	Typ <sup>(1)</sup>	Max	Min	Typ <sup>(1)</sup>	Max		
$T_J = -40^{\circ}C$	1	3.2	5	-5	-3.2	-1	-1100	South Pole
$T_J = 25^{\circ}C$	1	3	5	-5	-3.0	-1		
$T_J = 150^{\circ}C$	0.5	2.6	5	-5	-2.6	-0.5		

### 5.4. MLX92215LSE-AFA-000

DC Operating Parameters  $V_{DD} = 3.8$  to  $24V$ ,  $T_A = -40^{\circ}C$  to  $150^{\circ}C$

Test Condition	Operating Point $B_{OP}$ (mT)			Release Point $B_{RP}$ (mT)			TC (ppm/ $^{\circ}C$ )	Active Pole
	Min	Typ <sup>(1)</sup>	Max	Min	Typ <sup>(1)</sup>	Max		
$T_J = -40^{\circ}C$	1	3.2	5	-5	-3.2	-1	-1100	North Pole
$T_J = 25^{\circ}C$	1	3	5	-5	-3.0	-1		
$T_J = 150^{\circ}C$	0.5	2.6	5	-5	-2.6	-0.5		

<sup>1</sup> Typical values are defined at  $T_A = +25^{\circ}C$  and  $V_{DD} = 12V$

## 5.5. MLX92215KLD-AAA-000

DC Operating Parameters  $V_{DD} = 3.8$  to  $24V$ ,  $T_A = -40^\circ C$  to  $125^\circ C$

Test Condition	Operating Point $B_{OP}$ (mT)			Release Point $B_{RP}$ (mT)			TC (ppm/ $^\circ C$ )	Active Pole
	Min	Typ <sup>(1)</sup>	Max	Min	Typ <sup>(1)</sup>	Max		
$T_J = -40^\circ C$	1	3.2	5	-5	-3.2	-1	-1100	South Pole
$T_J = 25^\circ C$	1	3	5	-5	-3.0	-1		
$T_J = 125^\circ C$	0.5	2.6	5	-5	-2.6	-0.5		

Note:  $TC = \frac{B_{T_2} - B_{T_1}}{B_{25^\circ C} \times (T_2 - T_1)} \times 10^6, \left[ \frac{ppm}{^\circ C} \right]; T_1 = -40^\circ C; T_2 = 150^\circ C$

## 6. Output Behavior versus Magnetic Pole

Output behaviour versus magnetic pole <sup>(2)</sup>

### 6.1. South Pole Active

DC Operating Parameters  $T_A = -40^\circ C$  to  $150^\circ C$ ,  $V_{DD} = 2.7V$  to  $24V$

Parameter	Test Conditions	OUT
South pole	$B > B_{OP}$	Low ( $V_{DSon}$ )
North pole	$B < B_{RP}$	High ( $V_{PU}$ ) <sup>(3)</sup>

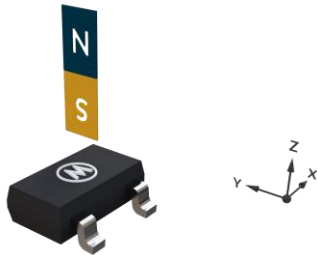

### 6.2. North Pole Active

DC Operating Parameters  $T_A = -40^\circ C$  to  $150^\circ C$ ,  $V_{DD} = 2.7V$  to  $24V$

Parameter	Test Conditions	OUT
South pole	$B > B_{OP}$	High ( $V_{PU}$ ) <sup>(3)</sup>
North pole	$B < B_{RP}$	Low ( $V_{DSon}$ )

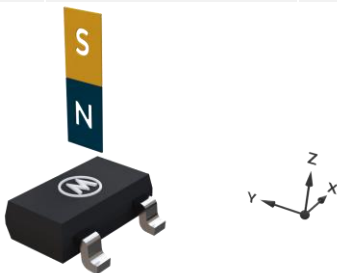

<sup>1</sup> Typical values are defined at  $T_A = +25^\circ C$  and  $V_{DD} = 12V$

<sup>2</sup> Magnetic pole facing the branded/top side of the package

<sup>3</sup> Default Output state during power-up

## 7. Performance Graphs

### 7.1. Magnetic parameters vs. $T_A$

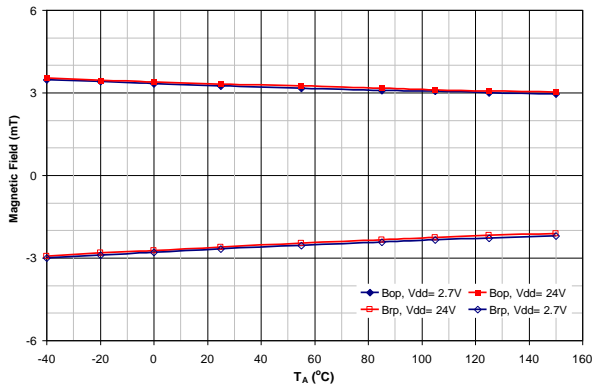

### 7.2. Magnetic parameters vs. $V_{DD}$

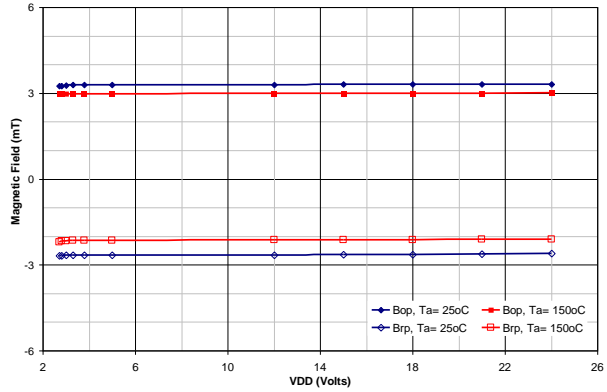

### 7.3. $V_{Dson}$ vs. $T_A$

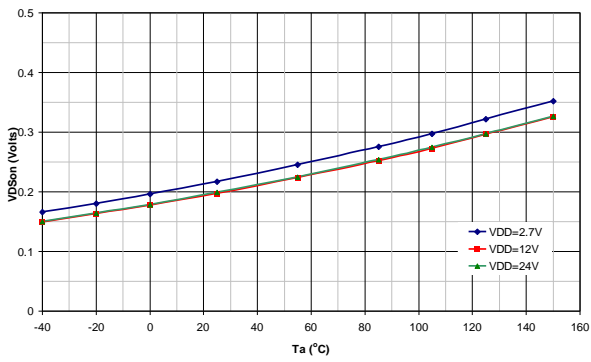

### 7.4. $V_{Dson}$ vs. $V_{DD}$

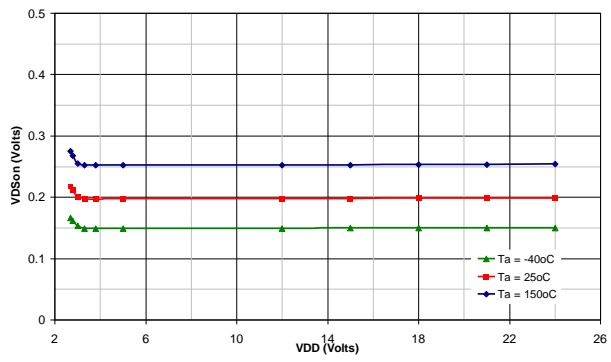

### 7.5. $I_{DD}$ vs. $T_A$

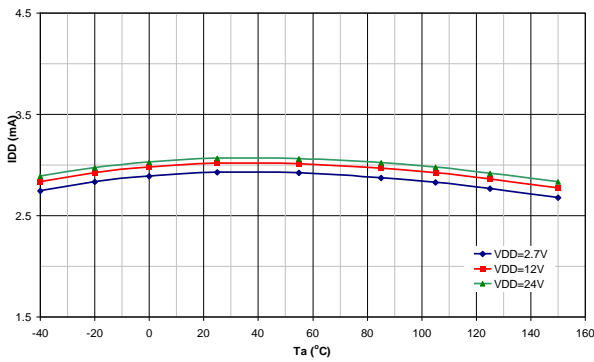

### 7.6. $I_{DD}$ vs. $V_{DD}$

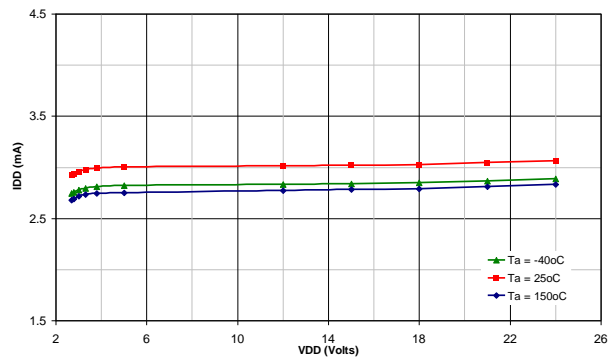



### 7.7. I<sub>OFF</sub> vs. T<sub>A</sub>

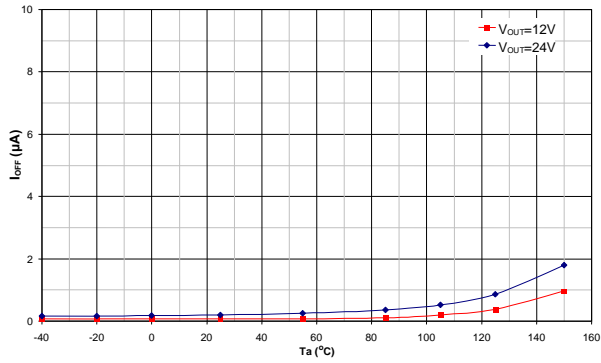

### 7.8. I<sub>OFF</sub> vs. V<sub>OUT</sub>

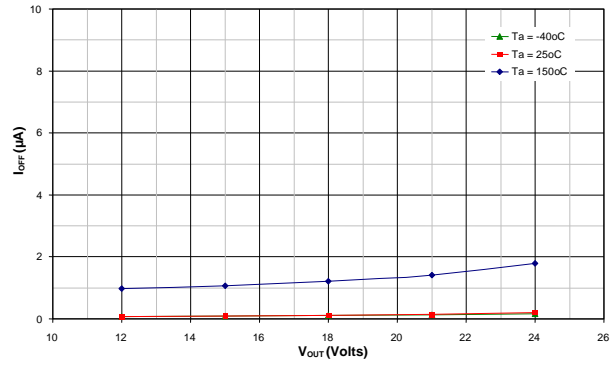

### 7.9. SE Power Derating vs. T<sub>A</sub>

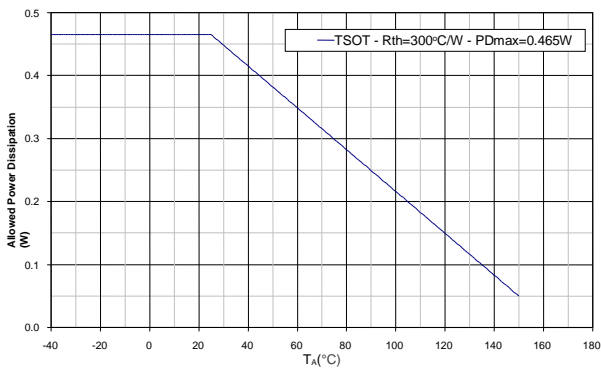

### 7.10. UA Voltage Derating vs. T<sub>A</sub>

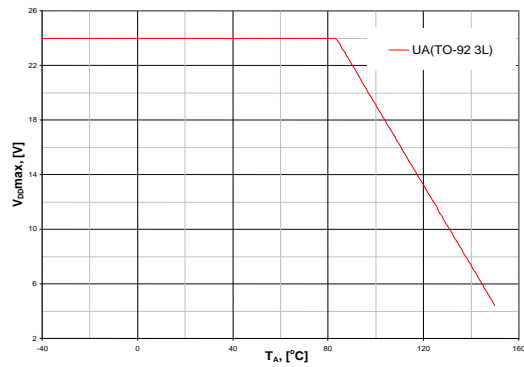

### 7.11. LD power Derating vs. T<sub>A</sub>

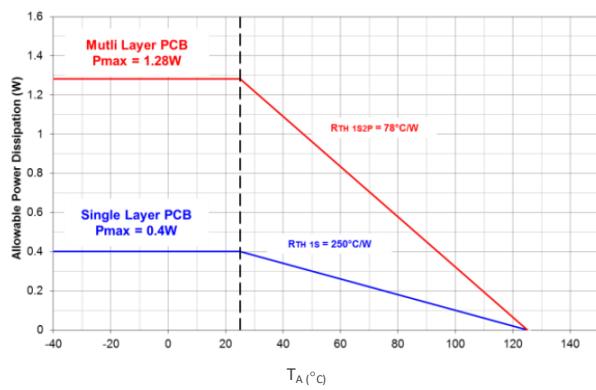

## 8. Application Information

### 8.1. Typical Three-Wire Application Circuit

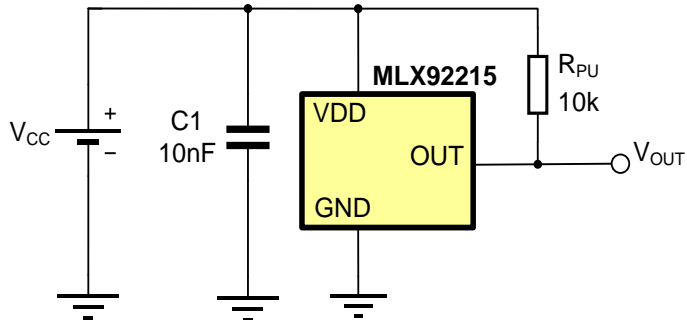

Notes:

1. For proper operation, a 10nF to 100nF bypass capacitor should be placed as close as possible to the V<sub>DD</sub> and ground pin.
2. The pull-up resistor R<sub>PU</sub> value should be chosen in to limit the current through the output pin below the maximum allowed continuous current for the device.
3. A capacitor connected to the output is not obligatory, because the output slope is generated internally.

## 9. Standard information regarding manufacturability of Melexis products with different soldering processes

Our products are classified and qualified regarding soldering technology, solderability and moisture sensitivity level according to following test methods:

### Reflow Soldering SMD's (Surface Mount Device)s

- IPC/JEDEC J-STD-020  
Moisture/Reflow Sensitivity Classification for Nonhermetic Solid State Surface Mount Devices (classification reflow profiles according to table 5-2)
- EIA/JEDEC JESD22-A113  
Preconditioning of Nonhermetic Surface Mount Devices Prior to Reliability Testing (reflow profiles according to table 2)

### Wave Soldering SMD's (Surface Mount Device)s and THD's (Through Hole Device)s

- EN60749-20  
Resistance of plastic- encapsulated SMD's to combined effect of moisture and soldering heat
- EIA/JEDEC JESD22-B106 and EN60749-15  
Resistance to soldering temperature for through-hole mounted devices

### Iron Soldering THD's (Through Hole Device)s

- EN60749-15  
Resistance to soldering temperature for through-hole mounted devices

### Solderability SMD's (Surface Mount Device)s and THD's (Through Hole Device)s

- EIA/JEDEC JESD22-B102 and EN60749-21  
Solderability

For all soldering technologies deviating from above mentioned standard conditions (regarding peak temperature, temperature gradient, temperature profile etc) additional classification and qualification tests have to be agreed upon with Melexis.

The application of Wave Soldering for SMD's is allowed only after consulting Melexis regarding assurance of adhesive strength between device and board.

Melexis is contributing to global environmental conservation by promoting **lead free** solutions. For more information on qualifications of **RoHS** compliant products (RoHS = European directive on the Restriction Of the use of certain Hazardous Substances) please visit the quality page on our website: <http://www.melexis.com/quality.aspx>

## 10. ESD Precautions

Electronic semiconductor products are sensitive to Electro Static Discharge (ESD). Always observe Electro Static Discharge control procedures whenever handling semiconductor products.

## 11. Packages

### 11.1. SE Package (TSOT-23) package information

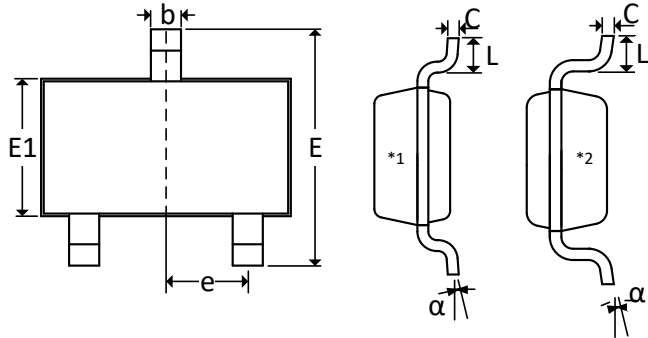

**Notes:**

1. All dimensions are in millimeters
2. Outermost plastic extreme width does not include mold flash or protrusions. Mold flash and protrusions shall not exceed 0.15mm per side.
3. Outermost plastic extreme length does not include mold flash or protrusions. Mold flash and protrusions shall not exceed 0.25mm per side.
4. The lead width dimension does not include dambar protrusion. Allowable dambar protrusion shall be 0.07mm total in excess of the lead width dimension at maximum material condition.
5. Dimension is the length of terminal for soldering to a substrate.
6. Formed lead shall be planar with respect to one another with 0.076mm at seating plane.

\*1: Valid for AAA,AEA,ACA

\*2: Valid for AFA

**Marking:**

Top side :

AAA/AEA: 15YY; YY: Year (last 2 digits)

ACA: 15CY; Y: Year

AFA: 15FY; Y: Year

Bottom side:

AAA/AEA/AFA: XXXX: Lot Number (last 4 digits)

ACA: XXXX: 3rd up to 6th characters of the Lot Number

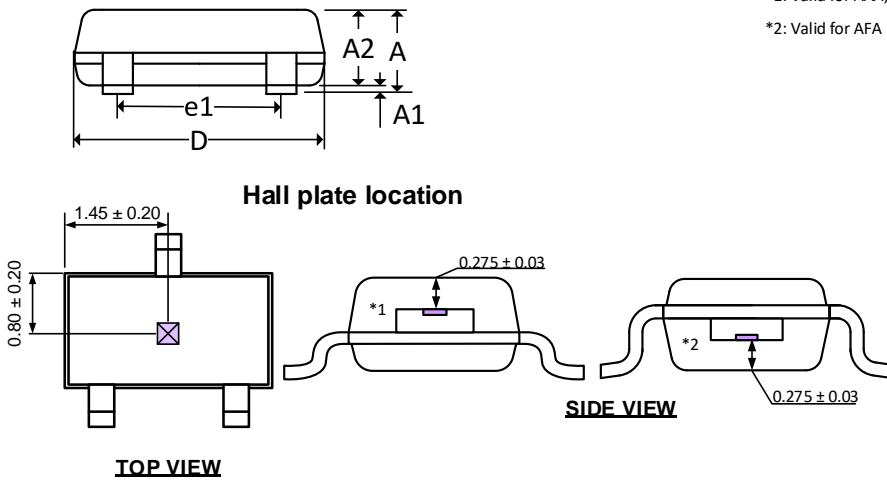

	A	A1	A2	D	E	E1	L	b	c	e	e1	$\alpha$
min	–	0.025	0.85	2.80	2.60	1.50	0.30	0.30	0.10	0.95	1.90	0°
max	1.00	0.10	0.90	3.00	3.00	1.70	0.50	0.45	0.20	BSC	BSC	8°

UA Pin №	Name	Type	Function
1	VDD	Supply	Supply Voltage pin
2	OUT	Output	Open drain output
3	GND	Ground	Ground pin

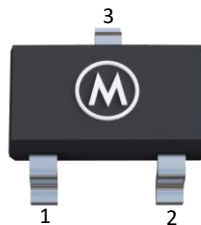

### 11.2. UA (TO92 - 3L) package information

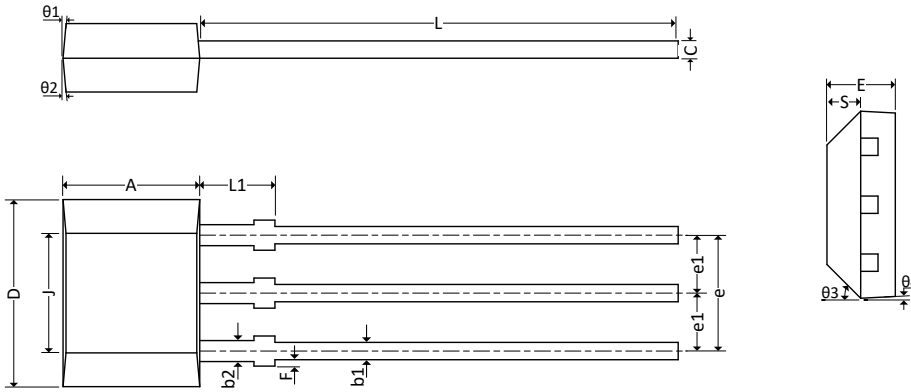

#### Hall plate location

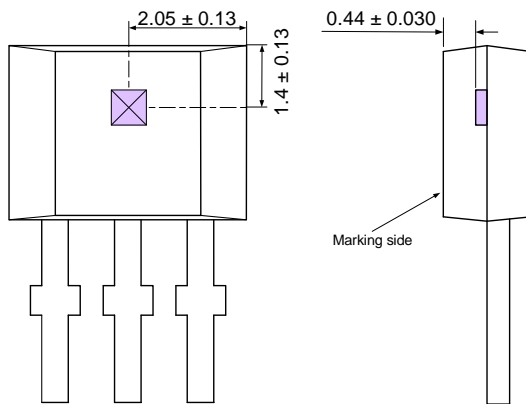

**Notes**

1. All dimensions are in millimeters
2. Package dimension exclusive molding flash
3. The end flash shall not exceed 0.127mm on the top side

**Marking:**

- Line1: 15EY; Y - last digit of year
- Line2: LLLL- last four digits from lot number

	A	D	E	F	J	L	L1	S	b1	b2	c	e	e1
min	2.80	3.90	1.40	0.00	2.51	14.0	0.90	0.63	0.35	0.43	0.35	2.51	1.24
max	3.20	4.30	1.60	0.15	2.72	15.0	1.10	0.84	0.44	0.52	0.44	2.57	1.30

  

	theta1	theta2	theta3	theta4
Min	7°	7°	45°	7°
max	REF	REF	REF	REF



UA Pin №	Name	Type	Function
1	VDD	Supply	Supply Voltage pin
2	GND	Ground	Ground pin
3	OUT	Output	Open drain output

### 11.3. LD (UTQFN) package information

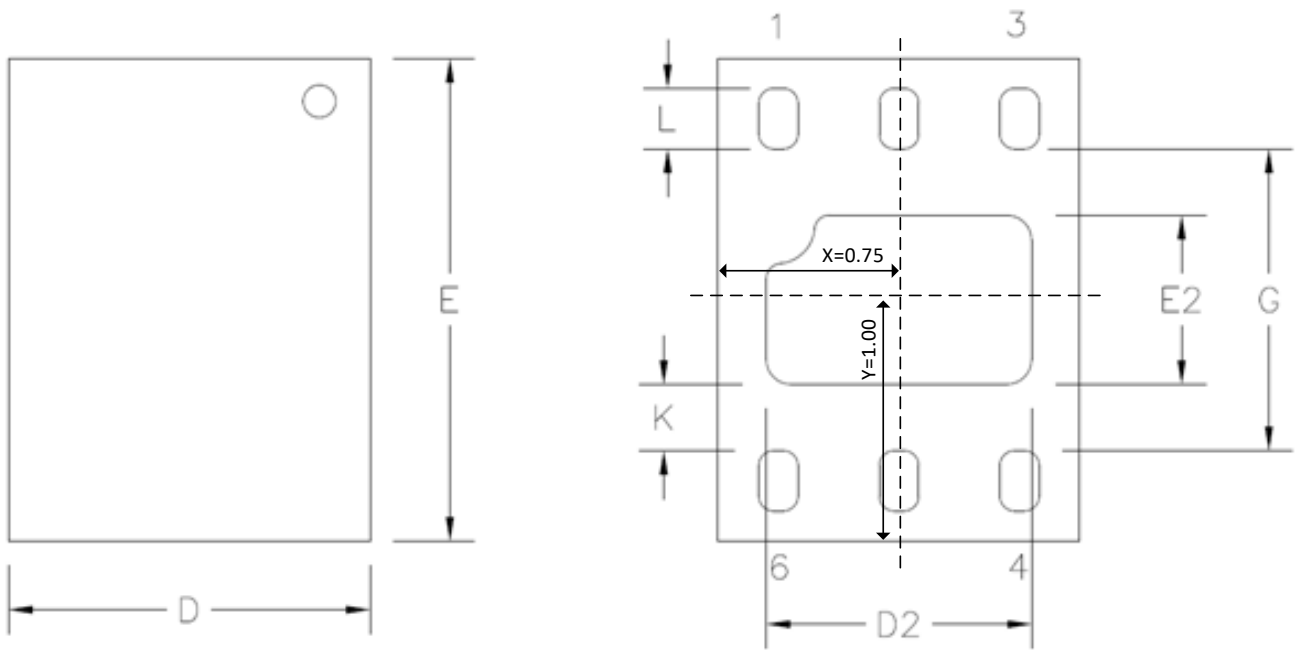

Marking:  
 Line1: .15  
 Line2: YWW; Y: Assembly Year, WW: Calendar week

Dimension X,Y and Z are related to the sensitive spot of the hall sensor.

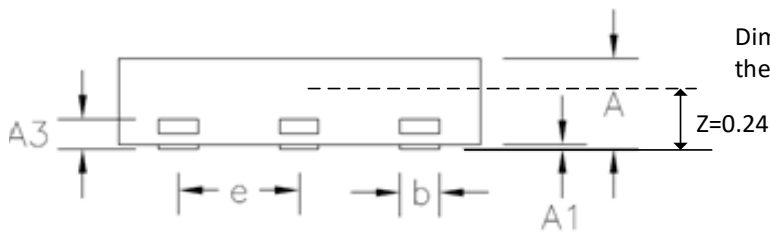

D x E	N	e		A	A1	A3	D2	E2	G	L	K	b
1.5 x 2	6	0.50	min	0.31	0.00	0.13	0.95	0.55	1.20	0.22	0.20	0.18
			max	0.40	0.05	REF	1.20	0.90	1.30	0.43	-	0.30

- Note:
1. all dimensions are in millimeters.
  2. General tolerance of D and E is  $\pm 0.1\text{mm}$ .
  3. Bottom pin1 identification is may vary depends on the suppliers.

LD Pin №	Name	Type	Function
1	VDD	Supply	Supply voltage pin
2	N.C.		Not connected
3	GND	Ground	Ground pin
4	GND	Ground	Ground pin
5	OUT	Output	Open drain output
6	N.C.		Not connected
7	Thermal	Thermal pad	Exposed thermal pad <sup>(1)</sup>

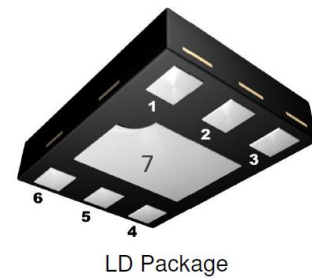

<sup>1</sup> The exposed pad can be soldered to the PCB to improve thermal dissipation. Can be connected to the ground potential.

## 12. Contact

For the latest version of this document, go to our website at [www.melexis.com](http://www.melexis.com).

For additional information, please contact our Direct Sales team and get help for your specific needs:

Europe, Africa	Telephone: +32 13 67 04 95
	Email : sales_europe@melexis.com
Americas	Telephone: +1 603 223 2362
	Email : sales_usa@melexis.com
Asia	Email : sales_asia@melexis.com

## 13. Disclaimer

*The content of this document is believed to be correct and accurate. However, the content of this document is furnished "as is" for informational use only and no representation, nor warranty is provided by Melexis about its accuracy, nor about the results of its implementation. Melexis assumes no responsibility or liability for any errors or inaccuracies that may appear in this document. Customer will follow the practices contained in this document under its sole responsibility. This documentation is in fact provided without warranty, term, or condition of any kind, either implied or expressed, including but not limited to warranties of merchantability, satisfactory quality, non-infringement, and fitness for purpose. Melexis, its employees and agents and its affiliates' and their employees and agents will not be responsible for any loss, however arising, from the use of, or reliance on this document. Notwithstanding the foregoing, contractual obligations expressly undertaken in writing by Melexis prevail over this disclaimer.*

*This document is subject to change without notice, and should not be construed as a commitment by Melexis. Therefore, before placing orders or prior to designing the product into a system, users or any third party should obtain the latest version of the relevant information.*

*Users or any third party must determine the suitability of the product described in this document for its application, including the level of reliability required and determine whether it is fit for a particular purpose.*

*This document as well as the product here described may be subject to export control regulations. Be aware that export might require a prior authorization from competent authorities. The product is not designed, authorized or warranted to be suitable in applications requiring extended temperature range and/or unusual environmental requirements. High reliability applications, such as medical life-support or life-sustaining equipment or avionics application are specifically excluded by Melexis. The product may not be used for the following applications subject to export control regulations: the development, production, processing, operation, maintenance, storage, recognition or proliferation of:*

- 1. chemical, biological or nuclear weapons, or for the development, production, maintenance or storage of missiles for such weapons;*
- 2. civil firearms, including spare parts or ammunition for such arms;*
- 3. defense related products, or other material for military use or for law enforcement;*
- 4. any applications that, alone or in combination with other goods, substances or organisms could cause serious harm to persons or goods and that can be used as a means of violence in an armed conflict or any similar violent situation.*

*No license nor any other right or interest is granted to any of Melexis' or third party's intellectual property rights.*

*If this document is marked "restricted" or with similar words, or if in any case the content of this document is to be reasonably understood as being confidential, the recipient of this document shall not communicate, nor disclose to any third party, any part of the document without Melexis' express written consent. The recipient shall take all necessary measures to apply and preserve the confidential character of the document. In particular, the recipient shall (i) hold document in confidence with at least the same degree of care by which it maintains the confidentiality of its own proprietary and confidential information, but no less than reasonable care; (ii) restrict the disclosure of the document solely to its employees for the purpose for which this document was received, on a strictly need to know basis and providing that such persons to whom the document is disclosed are bound by confidentiality terms substantially similar to those in this disclaimer; (iii) use the document only in connection with the purpose for which this document was received, and reproduce document only to the extent necessary for such purposes; (iv) not use the document for commercial purposes or to the detriment of Melexis or its customers. The confidentiality obligations set forth in this disclaimer will have indefinite duration and in any case they will be effective for no less than 10 years from the receipt of this document.*

*This disclaimer will be governed by and construed in accordance with Belgian law and any disputes relating to this disclaimer will be subject to the exclusive jurisdiction of the courts of Brussels, Belgium.*

*The invalidity or ineffectiveness of any of the provisions of this disclaimer does not affect the validity or effectiveness of the other provisions. The previous versions of this document are repealed.*

*Melexis © - No part of this document may be reproduced without the prior written consent of Melexis. (2020)*

*IATF 16949 and ISO 14001 Certified*