

Type 0AKN

Electric Vehicle Power Fuses

0AKN Series

RoHS Compliant

Description

500VDC rated ceramic tube fuse

Features



- Design to EV fuse standard UL248-20
- Reliability performance design refer to ISO8820-8&GB/T31465.6
- Excellent DC performance
- Full compliance with EU Directive 2011/65/EU and amending directive 2015/863

Applications

EV/HEV/ESS Applications



Physical Specifications

Materials	Body : Ceramic
	Terminals : Tin Plated Copper
Marking	On Fuse :
	"bel", "0AKN"
	"Current Rating", "Voltage Rating"
	On Label :
	"bel", "0AKNX", "Current Rating", "Voltage Rating", "Interrupting Rating", and "  ", "  "(China RoHS compliant).

Ratings

Ampere Rating / Voltage Rating	Ampere Range / Volt @ I.R. ability*
100A-250A / 500V DC	100A-250A / 500V @ 50kA DC
*I.R.= Interrupting Rating = Short Circuit Rating(Amps)	

Temperature Derating Curve

Operating Temperature: -40°C to +125°C, with proper derating factor applied

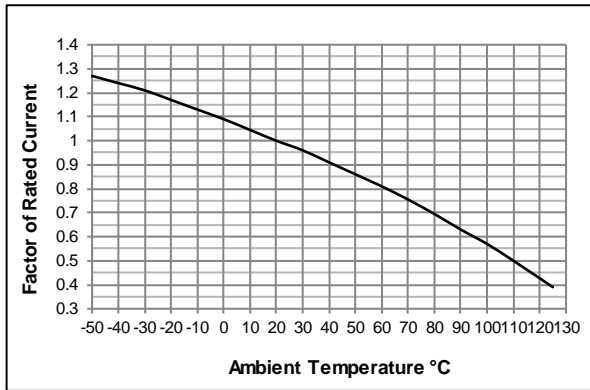

Re-rating with High altitude

The high altitude load calculation formula is:
 $I = I_n * (1 - (h-2000)/100 * (0.5/100))$,
 where h is an elevation, not more than 5000

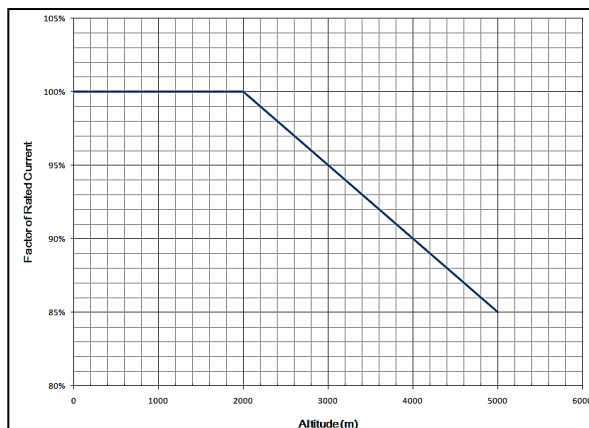

Average Time Current Curve

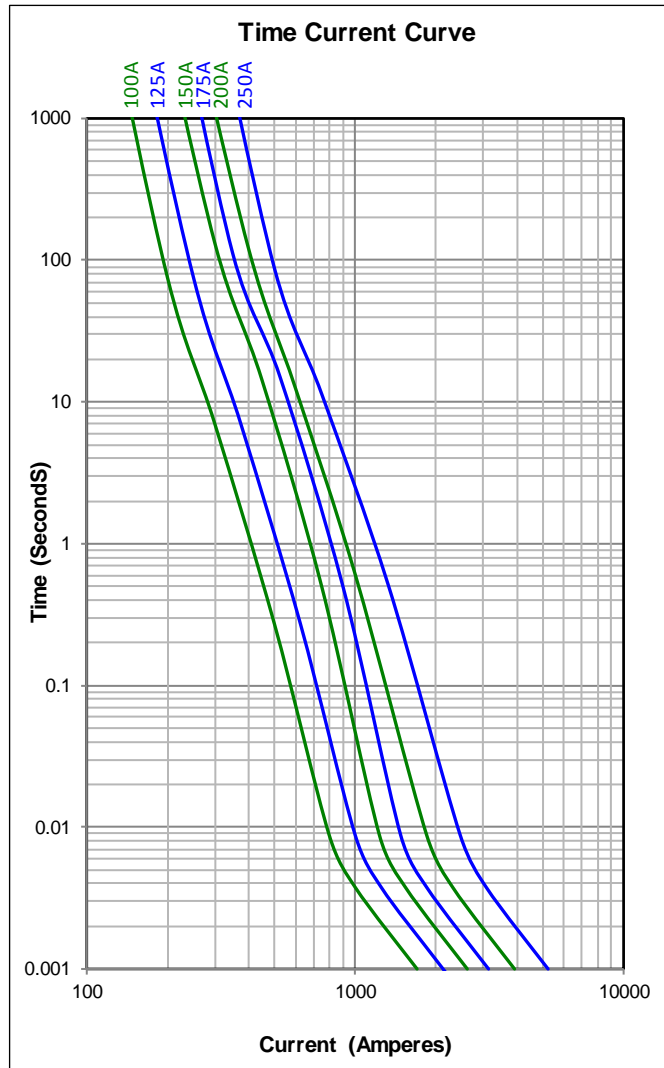

Electrical Specifications

Part Number	Rated Current	Voltage and Interrupting Ratings	I2t (A2sec)		Power Loss (W)
			Pre-arcing	Total @ 500Vdc	
0AKNxK100-xx	100A	See Table of Ratings on Page 1 for Voltage and associated Interrupting Ratings	1770	7020	14.9
0AKNxK125-xx	125A		2850	11500	19.3
0AKNxK150-xx	150A		4150	15770	23.1
0AKNxK175-xx	175A		5970	22850	27.5
0AKNxK200-xx	200A		9350	36500	30.8
0AKNxK250-xx	250A		16600	67800	35.2

Consult manufacturer for other ratings



Specifications subject to change without notice

Bel Fuse Inc.
 206 Van Vorst Street
 Jersey City, NJ 07302 USA

+1 201.432.0463
 Bel.US.CS@belf.com
belfuse.com/circuit-protection

Type 0AKN

Fuse FGNO Explanation

0AKN X [XXXX] -XX

0AKNB=0AKNB; [XXXX]=Ampere Rating; XX=See Ordering Information as below

Amps	Bel FGNO[XXXX]
100A	K100
125A	K125
150A	K150
175A	K175
200A	K200
250A	K250

Mechanical Dimensions

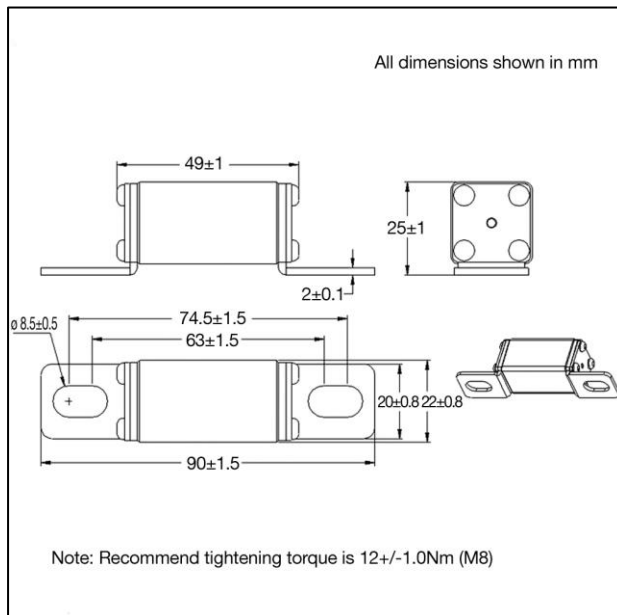

Ordering Information

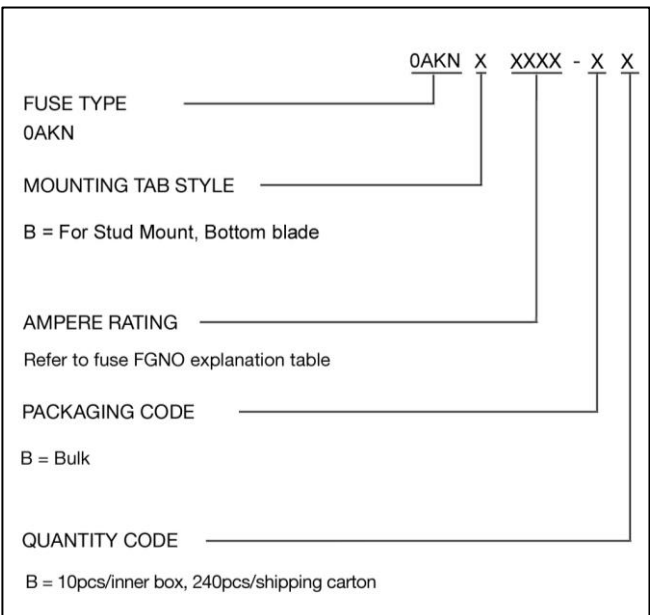

Packaging

Packaging Option	Quantity	Packaging Code
Bulk	10pcs/inner box, 240pcs/shipping carton	BB



Specifications subject to change without notice

Bel Fuse Inc.
206 Van Vorst Street
Jersey City, NJ 07302 USA

+1 201.432.0463
Bel.US.CS@belf.com
belfuse.com/circuit-protection